

# Top-Guided Single-Seated Control Valves

Model AGVB\_\_\_/AGVM\_\_\_

## OVERVIEW

Top-guided Single-seat Control Valve features a compact valve body with excellent flow control and minimal pressure loss. Model AGVB\_\_\_/AGVM\_\_\_ have large Cv values, high range ability, and accurate flow control performance.

When securely held in place by a top-guided stem with a long stroke, the valve plug is highly resistant against vibration and provides flow shutoff performance that fully satisfies IEC standards.

The valve also features a compact but powerful multi-spring actuator.

Model AGVB/AGVM control valves are especially suitable for process control applications where high reliability and tight flow shutoff are essential.

Model AGB/AGM is compliant to Functional Safety Standard (IEC61508).

## 1. Selection of model AGVB/AGVM specifications

Selection of control valves has traditionally required knowledge and experience. However, Model AGVB/AGVM offers you more accurate product specifications, so that you can easily pinpoint the control valve that satisfies fluid specifications (such as flowrate, pressure, and temperature) at your plant and provides the functions that you need.

If you do not find a valve that completely satisfies your requirements, contact the Azbil Group representative for assistance.

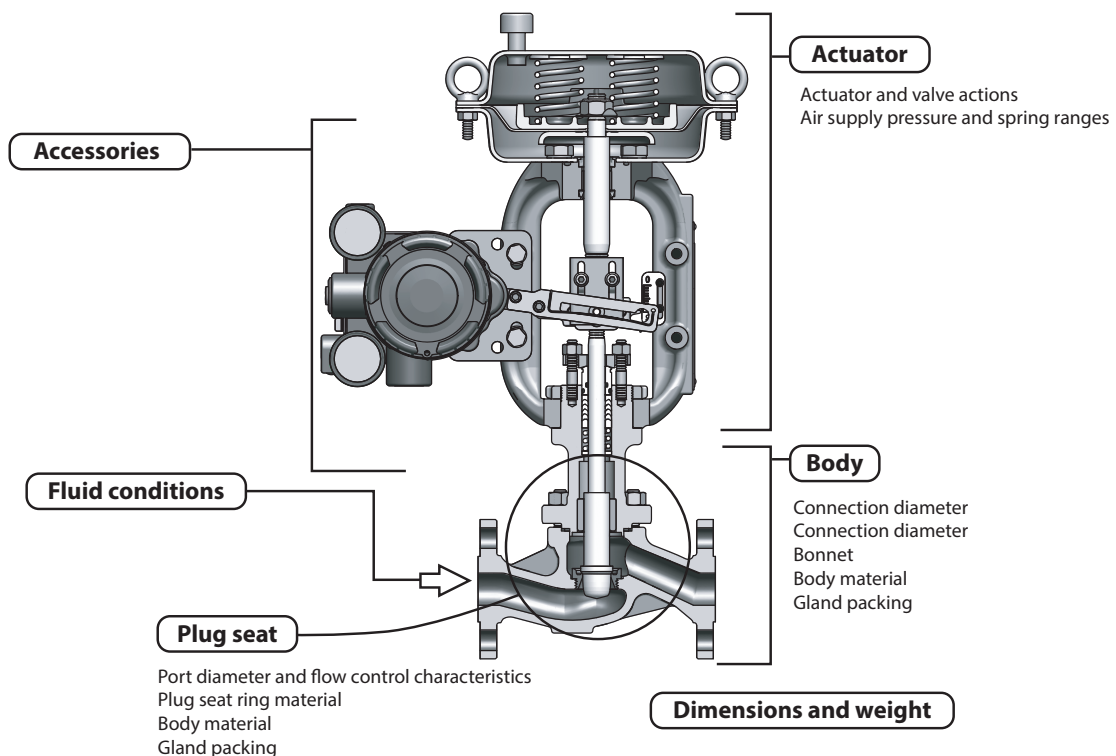


Figure 1. Model AGVB/AGVM selection map

## 2. Basic model numbers

### Basic model: 1/2 to 4 inches

Model AGVB\_\_\_: JIS 10K, ANSI 150, JPI 150

Model AGVM\_\_\_: JIS 16K, JIS 20K, JIS 30K,  
ANSI 300, JPI 300

## 3. Body part optional specifications

Figure 2 shows optional specifications of the body.

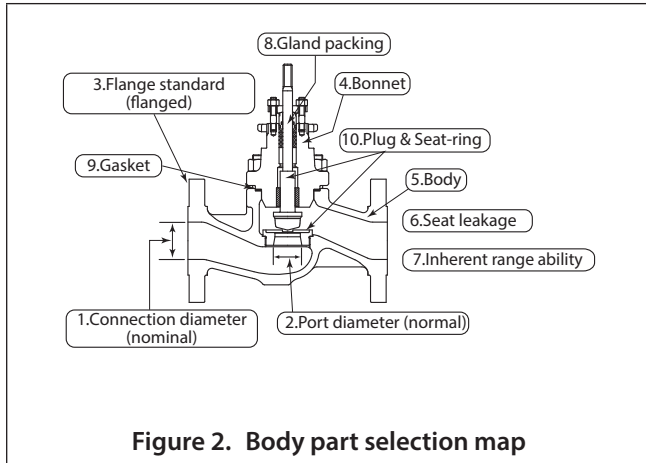


Figure 2. Body part selection map

### 3-1 Nominal size

Azbil Corporation manufactures diameters from 1/2 inch (15 mm) to 4 inches (100 mm) as shown in Table 6.

### 3-2 Port size and flow characteristics

The selection of the port size and the rated Cv value falls within the scope of Table 1 according to the Nominal size. For nominal sizes 1 inch (25 mm) or less, port sizes are expressed in terms of Cv values. Flow characteristics depend on the rated Cv value, be set to linear model or equal percentage model.

Based on the rated Cv value and the calculated necessary Cv value, check the controllability (valve position) using the flow control characteristics Tables in Figure 4, 5, 6, 7 and 8.

### 3-3 Pressure rating and end connection (flange type)

Flanged end	Pressure rating	Standard
RF	JIS 10K, 16K, 20K, 30K	JIS B2210-1984
	ANSI 150, 300	ASME/ANSI B16.5-1988
	JPI 150, 300	JPI-7S-15-1993

Option: Socket weld, butt weld

### 3-4 Bonnet style

We manufacture bonnets that can be used at fluid temperatures ranging from -196°C to +400°C.

The standard of plain bonnet is integral structure. (In case of with PSA6R actuator, plain bonnet is welded structure.) The standards of Extension type I and II bonnet are welded structure.

Table 1. Selection of bonnet

[Unit: °C]

Bonnet	Body material	SCPH 2	SCS13A/SCS14A
Plain		-5 to +230	-17 to +230
Extension type I (High•Low temperature)		+230 to +400	-45 to -17 +230 to +400
Extension type II (Liquid O <sub>2</sub> •N <sub>2</sub> )		-	-196 to -45

### 3-5 Body, plug and seat ring materials

For combinations of body, plug and seat ring materials and their applicable temperature ranges, see Table 7. In some ranges the plug seat ring material needs hardening treatment. See Figure 10. When you select a soft seat, refer to Figure 11.

### 3-6 Valve seat leakage

For the seat leak performance when the valve is fully closed, select from among the following four classifications, which conform to IEC 60534-4:2006 and JIS B 2005-4:2008 :

Class IV:	10 <sup>-4</sup> × rated Cv value (0.01% of rated Cv value)
Class IV-S1:	5 × 10 <sup>-6</sup> × rated Cv value (0.0005% of rated Cv value)
Class V:	1.8 × 10 <sup>-4</sup> × ΔP (MPa) × Port size (L/h)
Class VI:	3 × ΔP (MPa) × leakage coefficient (mL/min) (Table2)

Table 2. Leakage coefficient value

Nominal size inch (mm)	1 (25)	1-1/4 (32)	1-1/2 (40)	2 (50)	2-1/2 (65)	3 (80)	4 (100)
Leakage coefficient	0.15	0.17	0.23	0.36	0.51	0.62	1.20

**3-7 Inherent range ability:**

**Table 3. Inherent range ability Vs rated Cv value**

Rated Cv	Inherent Range ability
0.1, 0.16, 0.25, 0.4	20:1
0.63	30:1
1.0 or more than 1.0	50:1(75:1*)

\*Optional, metal seat and equal percentage only.

**3-8 Gland packing**

According to your application, select appropriate type of gland packing from among the following:

**Table 4. Selection of gland packing**

Application	Packing Type	Fluid temperature range
		Maximum working pressure
General use (Oil, Various chemical, Acid and Alkali, etc.)	PTFE fiber yarn packing with carbon fiber core packing [P4519]	-17 to +230 °C
		10MPa Max.
General use or oil free (Various chemical, acid and alkali)	V shaped pure PTFE packing [Pure PTFE]	-196 to +230 °C
		10MPa Max.
Vacuum and General use or oil free (Various chemical, acid and alkali)	V shaped pure PTFE packing (Dir. + Rev.) [Pure PTFE (Dir. + Rev.)]	-196 to +230 °C
		10MPa Max.
Low or standard temperature (Various chemical, acid and alkali, LNG, etc.)	V shaped pure PTFE packing + PTFE fiber yarn packing or PTFE braided packing [Pure PTFE +PTFE fiber]	Up to -196 °C
		10MPa Max.
High temperature	Expanded graphite packing + Aramid fiber reinforced expanded graphite yarn packing *1	+400 °C Max
		43MPa Max.
Measures against VOC *2 exhaust regulation [ISO15848-1 certified low emission packing system]	Packing with Live Load structure *3	*3

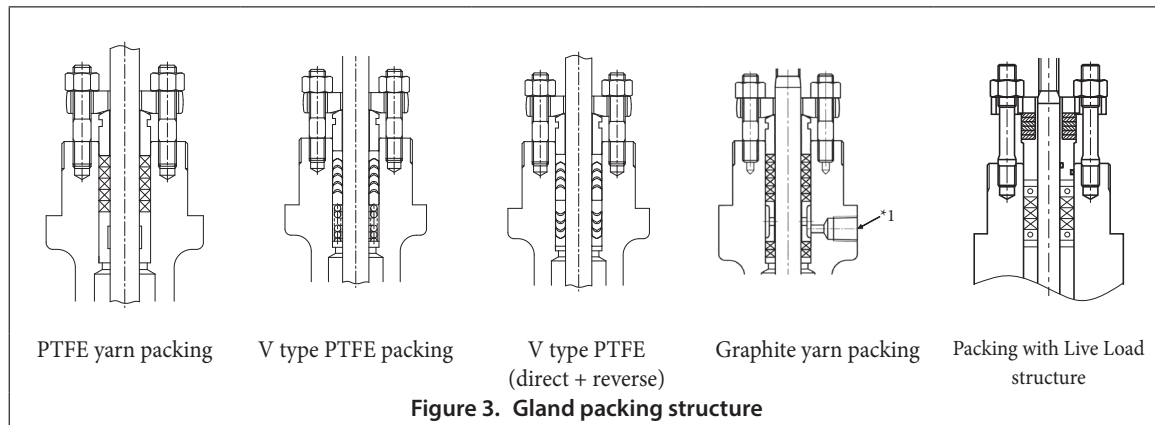
Note) PTFE: polytetrafluoroethylene resin

\*1 Grease provided

It cannot be applied to PSA1 actuator (spring range 20 to 98 kPa).

\*2 Volatile Organic Compound

\*3 Refer to special spec sheet No.SS2-SSL100-0100 about detail of Low emission gland packing.



Note) \*1 Grease provided by lubricator

3-9 Gasket

Table 5. Selection of gasket

	Cryogenic temperature / Oil-free (Liquid O <sub>2</sub> ·N <sub>2</sub> )	General / Low temp.	High temperature	Oil-free treatment
Between bonnet and body	Spiral-shaped gasket Hoop material: SUS316 Filler material: PTFE	Metal gasket (PTFE coating) V543(PTFE)	Metal gasket V543	Metal gasket (PTFE coating) V543 (PTFE)
Between seat ring and body	Metal gasket	Not necessary	Metal gasket V564 (Ni-Cu Alloy)	Metal gasket (PTFE coating) V563 (PTFE)

Table 6. Model AGVB/AGVM Cv values and travel

Nominal size inches (mm)	1 (25)						1-1/2 (40)			2(50)		2-1/2(65)			3(80)		4(100)				
	3/4 (20)						1	1-1/4	1-1/2	1-1/4	1-1/2	2	1-1/2	2	2-1/2	2	2-1/2	3	2-1/2	3	4
	1/2 (15)																				
Port size (inch)	0.1	0.4	1.0	2.5	8.0	10	1	1-1/4	1-1/2	1-1/4	1-1/2	2	1-1/2	2	2-1/2	2	2-1/2	3	2-1/2	3	4
Rated Cv value	0.16	0.63	1.6	4.0	6.3	14	14	21	30	21	30	50	30	50	85	50	85	115	85	115	200
Rated travel (mm)	20						20			20		38			38		38				
Flow characteristics	Fig. 4		Fig. 5				Fig. 6, 7, 8														

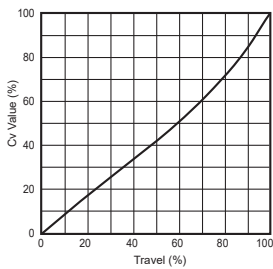


Figure 4. Cv values 0.1, 0.16, and 0.25 for 1 inch port size or less (linear model)

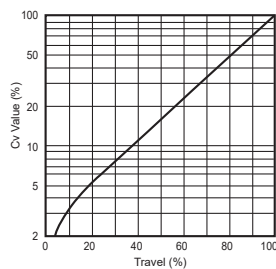


Figure 5. Cv values 0.4 to 14 for 1 inch port size or less (equal percentage model)

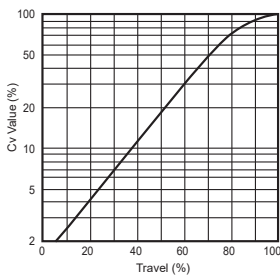


Figure 6. Port size 1-1/2 to 4 inches (equal percentage model)

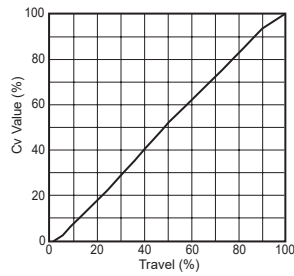


Figure 7. Cv values 0.4 to 14 (linear model)

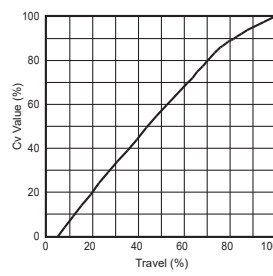


Figure 8. Port size 1-1/2 to 4 inches (linear model)

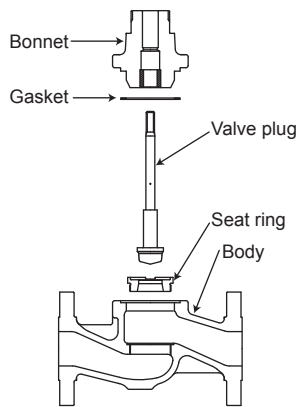
### 3-10 Body and trim material combinations

#### 3-10-1 Selecting the materials of the body, plug, and seat ring

Depending on the material of the body, the operating temperature range of the trim material varies. Select the body and trim material according to the operating temperature of the control valve. In addition, refer to Figure 10 to determine whether hardening treatment is necessary for the trim.

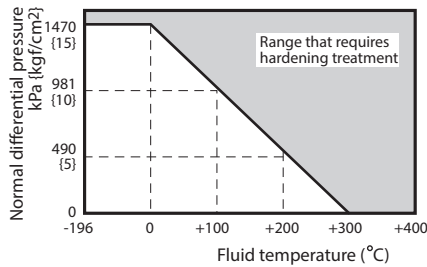
**Table 7. Combinations of body, plug, and seat ring materials**

Material combination		Fluid temperature ranges (°C)		
SUS 316		-5 to +300	-45 to +300	-45 to +300
SUS 316 CoCr-A		-5 to +400	-196 to +400	-196 to +400
SUS440C		-5 to +400	-45 to +400	---
SUS 316 soft seat		-5 to +230	-45 to +230	-45 to +230
SUS 316 CoCr-A face		-5 to +400	-196 to +400	-196 to +400
SUS 316L		---	-45 to +300	-45 to +300
SUS 316L CoCr-A		---	-196 to +400	-196 to +400
Body material	JIS	SCPH2	SCS13A	SCS14A
	ASTM	A216WCB	A351CF8	A351CF8M

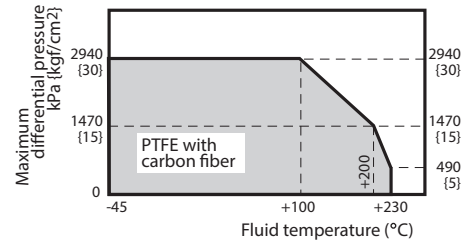


**Figure 9. Development view of Model AGVB/AGVM**

Note) \*1: Parts that adjust flow (such as a plug and a seat ring) are referred to as the valve trim.



**Figure 10. Temperature and normal differential pressure ranges requiring hardening treatment**



**Figure 11. Temperature and maximum differential pressure ranges for soft seat**

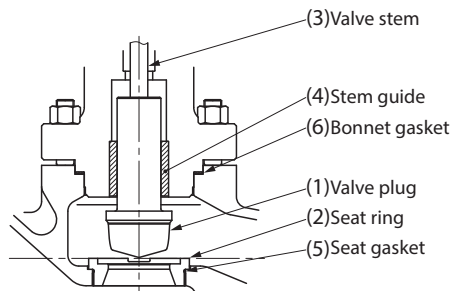
- Note) 1. Depending on the methods of hardening treatment, CoCr-A welding or SUS440C is available.
2. For valves for cavitation/flashing service, oil-proof service, or tight shutoff service, a CoCr-A is recommended regardless of process fluid temperatures or differential pressures.
3. For cold water or for hot water exceeding 100 °C (fluids that do not require consideration of corrosiveness), SUS440C is recommended.

- Note) 1. When there is a possibility of erosion by such fluids as saturated steam and heated water please use metal seats.
2. With the fluid connecting parts (inside the body) the material of the seat which oil-proof washing treatment had been completed is PTFE entered with glass.

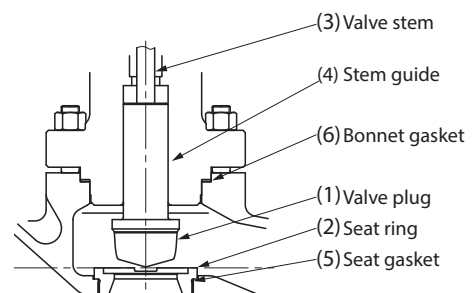
#### 3-10-2 Combination of body component materials

Following table shows typical body and trim material combinations.

Based on the trim material selected in the above section, select the material of body components such as gaskets.



**Figure 12. Trim structure (with guide bushing)**



**Figure 13. Trim structure (without guide bushing)**

**Table 8. The valve body material is carbon steel (SCPH2/A216WCB).**

(1) Valve plug (2) Seat ring	SUS316		SUS440C	SUS316 CoCr-A SUS316 CoCr-A face		SUS316 soft seat	
	General	Oil-free	General	General	Oil-free	General	Oil-free
(3) Valve stem	SUS316						
(4) Stem guide	SUS440C	SUS316 CoCr-A face	SUS440C	SUS316 CoCr-A	SUS316 CoCr-A	SUS440C	SUS316 CoCr-A face
(5) Seat gasket	Without (Design temperature: -17 to +230°C)	SUS316 (PTFE coating)	Without (Design temperature: -17 to +230°C)	Without (Design temperature: -17 to +230°C)	SUS316 (PTFE coating)	Without	SUS316 (PTFE coating)
	Ni-Cu Alloy (Design temperature: above +230°C)		Ni-Cu Alloy (Design temperature: above +230°C)	Ni-Cu Alloy (Design temperature: above +230°C)			
(6) Bonnet gasket	SUS316(PTFE coating) (Design temperature: -17 to +230°C)	SUS316 (PTFE coating)	SUS316(PTFE coating) (Design temperature: -17 to +230)	SUS316(PTFE coating) (Design temperature: -17 to +230°C)	SUS316 (PTFE coating)	SUS316 (PTFE coating)	SUS316 (PTFE coating)
	SUS316 (Design temperature: above +230°C)		SUS316 (Design temperature: above +230)	SUS316 (Design temperature: above +230°C)			

(1) Valve plug (2) Seat ring	SUS316L		SUS316L CoCr-A		SUS316L soft seat	
	General	Oil-free	General	Oil-free	General	Oil-free
(3) Valve stem	SUS316L					
(4) Stem guide	SUS316L	SUS316L CoCr-A face	SUS316L CoCr-A	SUS316L CoCr-A	SUS316L	SUS316L CoCr-A face
(5) Seat gasket	Without (Design temperature: -17 to +230°C)	SUS316 (PTFE coating)	Without (Design temperature: -17 to +230°C)	SUS316 (PTFE coating)	Without	SUS316 (PTFE coating)
	Ni-Cu Alloy (Design temperature: above +230°C)		Ni-Cu Alloy (Design temperature: above +230°C)			
(6) Bonnet gasket	SUS316(PTFE coating) (Design temperature: -17 to +230°C)	SUS316 (PTFE coating)	SUS316(PTFE coating) (Design temperature: -17 to +230°C)	SUS316 (PTFE coating)	SUS316 (PTFE coating)	SUS316 (PTFE coating)
	SUS316 (Design temperature: above +230°C)		SUS316 (Design temperature: above +230°C)			

**Table 9. The valve body material is stainless steel (SCS13A/A351CF8 or SCS14A/A351CF8M)**

(1) Valve plug (2) Seat ring	SUS316		SUS440C *1	SUS316 CoCr-A SUS316 CoCr-A face		SUS316 soft seat	
	General	Oil-free	General	General	Oil-free	General	Oil-free
(3) Valve stem	SUS316						
(4) Stem guide	Without: bonnet guide (Design temperature: -17 to +230°C)	SUS316 CoCr-A face	SUS440C	SUS316 CoCr-A	SUS316 CoCr-A	Without (bonnet guide) (Design temperature: -17 to +230°C)	SUS316 CoCr-A face
	SUS316 (Design temperature: above +230°C and below -17°C)					SUS316 (Design temperature: above +230°C and below -17°C)	
(5) Seat gasket	Without (Design temperature: -17 to +230°C and below -17°C)	SUS316 (PTFE coating)	Without (Design temperature: -17 to +230°C and below -17°C)	Without (Design temperature: -17 to +230°C and below -17°C)	SUS316 (PTFE coating)	Without	SUS316 (PTFE coating)
	Ni-Cu Alloy (Design temperature: above +230°C)		Ni-Cu Alloy (Design temperature: above +230°C)	Ni-Cu Alloy (Design temperature: above +230°C)			
(6) Bonnet gasket	SUS316(PTFE coating) (Design temperature: -17 to +230°C and below -17°C)	SUS316 (PTFE coating)	SUS316(PTFE coating) (Design temperature: -17 to +230°C and below -17°C)	SUS316(PTFE coating) (Design temperature: -17 to +230°C and below -17°C)	SUS316 (PTFE coating)	SUS316 (PTFE coating)	SUS316 (PTFE coating)
	SUS316 (Design temperature: above +230°C)		SUS316 (Design temperature: above +230°C)	SUS316 (Design temperature: above +230°C)			

(1) Valve plug (2) Seat ring	SUS316L		SUS316L CoCr-A		SUS316L soft seat	
	General	Oil-free	General	Oil-free	General	Oil-free
(3) Valve stem	SUS316L					
(4) Stem guide	Without: bonnet guide (Design temperature: -17 to +230°C)	SUS316L CoCr-A face	SUS316L CoCr-A	SUS316L CoCr-A	Without: bonnet guide (Design temperature: -17 to +230°C)	SUS316L CoCr-A face
	SUS316L (Design temperature: above +230°C and below -17°C)				SUS316L (Design temperature: below -17°C)	
(5) Seat gasket	Without (Design temperature: -17 to +230°C and below -17°C)	SUS316 (PTFE coating)	Without (Design temperature: -17 to +230°C and below -17°C)	SUS316 (PTFE coating)	Without	SUS316 (PTFE coating)
	Ni-Cu Alloy (Design temperature: above +230°C)		Ni-Cu Alloy (Design temperature: above +230°C)			
(6) Bonnet gasket	SUS316(PTFE coating) (Design temperature: -17 to +230°C and below -17°C)	SUS316 (PTFE coating)	SUS316(PTFE coating) (Design temperature: -17 to +230°C and below -17°C)	SUS316 (PTFE coating)	SUS316 (PTFE coating)	SUS316 (PTFE coating)
	SUS316 (Design temperature: above +230°C)		SUS316 (Design temperature: above +230°C)			

Note) \*1 SUS440C is applicable to body material SCS14A/A351CF8M.

## 4. Actuator

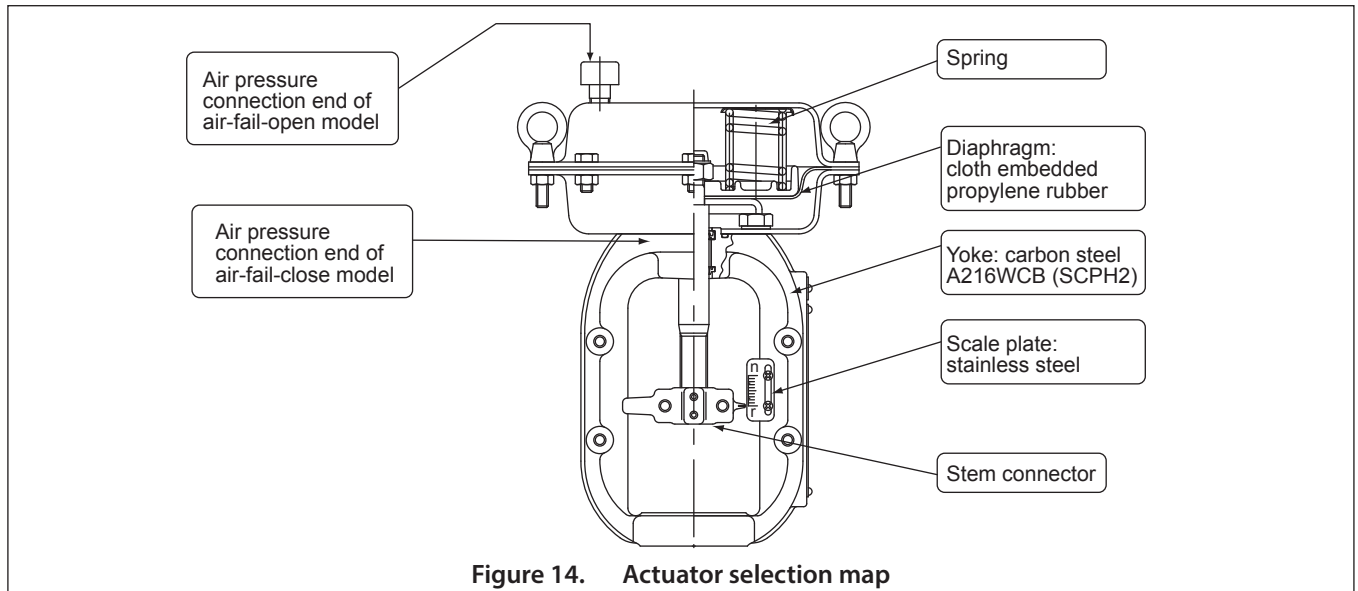


Figure 14. Actuator selection map

### 4-1 Actuator and valve actions

Selection of actuator actions determines valve actions (in response to input signals).

**Air-to-open:** actuator action where the valve opens as the input signal increases

**Air-to-close:** actuator action where the valve closes as the input signal increases

With the model AGVB/AGVM, the valve closes as the plug lowers. The valve action depends, in turn, on whether an air-to-open or air-to-close actuator is chosen. The material of bolt and nut are SUS304.

### 4-2 Tables of allowable differential pressures

Ensure the required shutoff differential pressure specified in the equipment design is satisfied by selecting an actuator with an allowable differential pressure equal to or higher than the shutoff pressure, according to the seat leakage class.

#### Leakage, specification Class IV (0.01% of rated Cv value)

- Model AGVB
  - Air-to-open: Table 10 and Table 11
  - Air-to-close: Table 12 and Table 13
- Model AGVM
  - Air-to-open: Table 14 and Table 15
  - Air-to-close: Table 16 and Table 17

#### Leakage, specification Class V (high shutoff model: metal seat) or Class IV-S1 (0.0005% of rated Cv value)

- Model AGVB
  - Air-to-open: Table 18 and Table 19
  - Air-to-close: Table 20 and Table 21
- Model AGVM
  - Air-to-open: Table 22 and Table 23
  - Air-to-close: Table 24 and Table 25

#### Leakage, specification Class VI (high shutoff model: soft seat)

- Model AGVB
  - Air-to-open: Table 26 and Table 27

Air-to-close: Table 28 and Table 29

- Model AGVM
  - Air-to-open: Table 30 and Table 31
  - Air-to-close: Table 32 and Table 33

At your request, we can manufacture control valves with normal pressures exceeding 1.96 MPa.

### 4-3 Supply pressure and spring ranges

Select the actuator using the table of allowable differential pressures. The table also assists in determining the actuator's required supply pressure and required spring range.

If the applicable value in the table of allowable differential pressures is not large enough for the shutoff pressure you need, we will, at your request, consider a larger actuator size.

### 4-4 Performance (with positioner)

Actuator		PSA1_	PSA2_to 4	PSA6
Linearity	VPE_ _	±3% F.S.	-	-
	AVP_ _ _	±2% F.S.	±1% F.S.	±2% F.S.
	HTP_ _ _			
Hysteresis error		1% F.S.	1% F.S.	2% F.S.

Note) \* This table shows PTFE-based packing.

### 4-6 Ambient temperature

-30 to 70 °C

## 5. Finish

The normal standard coating color for Azbil Corporation's control valves is blue (Munsell color 10B 5/10). Silver is also available as standard.

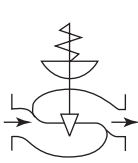
You can specify any other color using the number code of the Japan Paint Industry Assignment or the Munsell color system.

Standard colors are also used for such optional accessories as positioners, pressure regulator with filter, and solenoid valves.

**Valve seat leakage, Class IV: 0.01% of the rated Cv value**

**Table 10. Model AGVB nominal size 1/2, 3/4, and 1 inch**

Air-to-open

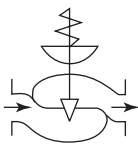


Nominal size (inch)	Actuator	Supply pressure kPa {kgf/cm <sup>2</sup> }	Spring range kPa {kgf/cm <sup>2</sup> }	Differential pressure (by Cv value) kPa {kgf/cm <sup>2</sup> }					
				0.1 0.16 0.25	0.4 0.63	1.0 1.6	2.5 4.0	6.3 8.0	10 14
1/2	PSA1R	140 {1.4}	20 to 98 {0.2 to 1.0}			1650 {16.8}	1020 {10.4}	550 {5.6}	410 {4.2}
3/4		270 {2.8}	80 to 240 {0.8 to 2.4}			1960 {20.0}			
1	PSA2R	140 {1.4}	20 to 98 {0.2 to 1.0}	--	--			1070 {10.9}	800 {8.2}

- Note) 1. In the case of using positioners, please the setting of supply pressure with pressure regulator.  
 2. The maximum allowable differential pressures must not exceed the maximum working pressures specified by JISB2201-1984, ANSIB16.34-1981, and JPI-7S-65-831.

**Table 11. Model AGVB nominal size 1-1/2, 2, 2-1/2, 3 and 4 inches**

Air-to-open



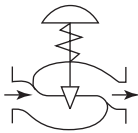
Nominal size (inch)	Actuator	Supply pressure kPa {kgf/cm <sup>2</sup> }	Spring range kPa {kgf/cm <sup>2</sup> }	Differential pressure (by port size (inch)) kPa {kgf/cm <sup>2</sup> }						
				1	1-1/4	1-1/2	2	2-1/2	3	4
1-1/2 2	PSA1R	140 {1.4}	20 to 98 {0.2 to 1.0}	410 {4.2}	250 {2.6}	170 {1.8}	100 {1.1}	--	--	--
		270 {2.8}	80 to 240 {0.8 to 2.4}	1960 {20.0}	1780 {18.2}	1210 {12.3}	720 {7.4}	--	--	--
	PSA2R	140 {1.4}	20 to 98 {0.2 to 1.0}	800 {8.2}	490 {5.0}	330 {3.4}	200 {2.0}	--	--	--
		270 {2.8}	80 to 240 {0.8 to 2.4}	--	1960 {20.0}		1400 {14.3}	--	--	--
	PSA3R	140 {1.4}	20 to 98 {0.2 to 1.0}	1420 {14.5}	880 {8.9}	590 {6.0}	350 {3.6}	--	--	--
		270 {2.8}	80 to 240 {0.8 to 2.4}	--	--	--	1960 {20.0}	--	--	--
PSA4R	140 {1.4}	20 to 98 {0.2 to 1.0}	1960 {20.0}	1510 {15.4}	1030 {10.5}	610 {6.2}	--	--	--	
2-1/2 3 4	PSA3R	140 {1.4}	20 to 98 {0.2 to 1.0}	--	--	590 {6.1}	350 {3.6}	220 {2.2}	160 {1.6}	--
		270 {2.8}	80 to 240 {0.8 to 2.4}	--	--	1960 {20.0}		1530 {15.6}	1100 {11.3}	620 {6.3}
	PSA4R	140 {1.4}	20 to 98 {0.2 to 1.0}	--	--	1030 {10.5}	610 {6.2}	380 {3.9}	270 {2.8}	150 {1.16}
		270 {2.8}	80 to 240 {0.8 to 2.4}	--	--	--	--	1960 {20.0}	1910 {19.4}	1070 {10.9}
	PSA6R	260 {2.6}	100 to 180 {1.0 to 1.8}	--	--	--	--	--	1960 {20.0}	1450 {14.8}
		400 {4.0}	200 to 340 {2.0 to 3.5}	--	--	--	--	--	--	1960 {20.0}

- Note) 1. In the case of using positioners, please the setting of supply pressure with pressure regulator.  
 2. The maximum allowable differential pressures must not exceed the maximum working pressures specified by JISB2201-1984, ANSIB16.34-1981, and JPI-7S-65-831.



**Valve seat leakage, Class IV: 0.01% of the rated Cv value****Table 12. Model AGVB nominal size 1/2, 3/4 and 1 inch**

Air-to-close

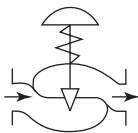


Nominal size inch	Actuator	Supply pressure kPa {kgf/cm <sup>2</sup> }	Spring range kPa {kgf/cm <sup>2</sup> }	Differential pressure (by Cv value) kPa {kgf/cm <sup>2</sup> }					
				0.1 0.16 0.25	0.4 0.63	1.0 1.6	2.5 4.0	6.3 8.0	10 14
1/2	PSA1D	140{1.4}	20 to 98 {0.2 to 1.0}					1380 {14.1}	1030 {10.5}
		160{1.6}	20 to 98 {0.2 to 1.0}	1960 {20.0}					1860 {18.9}
		390{4.0}	80 to 240 {0.8 to 2.4}						
1	PSA2D	140{1.4}	20 to 98 {0.2 to 1.0}	--	--	--	--		
		160{1.6}	20 to 98 {0.2 to 1.0}	--	--	--	--	--	

- Note) 1. In the case of using positioners, please the setting of supply pressure with pressure regulator.  
 2. The maximum allowable differential pressures must not exceed the maximum working pressures specified by JISB2201-1984, ANSIB16.34-1981, and JPI-7S-65-831.

**Table 13. Model AGVB nominal size 1-1/2, 2, 2-1/2, 3 and 4 inches**

Air-to-close



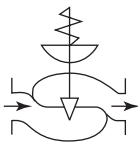
Nominal size (inch)	Actuator	Supply pressure kPa {kgf/cm <sup>2</sup> }	Spring range kPa {kgf/cm <sup>2</sup> }	Differential pressure (by port size (inch)) kPa{kgf/cm <sup>2</sup> }							
				1	1-1/4	1-1/2	2	2-1/2	3	4	
1-1/2 2	PSA1D	140 {1.4}	20 to 98 {0.2 to 1.0}	1030 {10.5}	640 {6.5}	430 {4.4}	260 {2.6}	--	--	--	
		160 {1.6}	20 to 98 {0.2 to 1.0}	1860 {18.9}	1150 {11.7}	780 {7.9}	460 {4.7}	--	--	--	
		390 {4.0}	80 to 240 {0.8 to 2.4}					1500 {15.3}	--	--	--
	PSA2D	140 {1.4}	20 to 98 {0.2 to 1.0}	1960 {20.0}	1230 {12.6}	840 {8.5}	500 {5.1}	--	--	--	
		160 {1.6}	20 to 98 {0.2 to 1.0}		1510 {15.4}	900 {9.2}	--	--	--		
		390 {4.0}	80 to 240 {0.2 to 1.0}	--	--	--	1960 {20.0}	--	--	--	
	PSA3D	140 {1.4}	20 to 98 {0.2 to 1.0}	--	1960 {20.0}	1490 {15.1}	890 {9.0}	--	--	--	
		160 {1.6}	20 to 98 {0.2 to 1.0}	--	--	1960 {20.0}	1600 {16.3}	--	--	--	
		140 {1.4}	20 to 98 {0.2 to 1.0}	--	--		1530 {15.6}	--	--	--	
PSA4D	160 {1.6}	20 to 98 {0.2 to 1.0}	--	--	--	1960 {20.0}	--	--	--		
	PSA3D	140 {1.4}	20 to 98 {0.2 to 1.0}	--	--	1960 {20.0}	1490 {15.1}	890 {9.0}	550 {5.6}	390 {4.0}	220 {2.3}
		160 {1.6}	20 to 98 {0.2 to 1.0}	--	--		1600 {16.3}	990 {10.0}	710 {7.2}	400 {4.1}	
390 {4.0}		80 to 240 {0.8 to 2.4}	--	--					1290 {13.1}		
4	PSA4D	140 {1.4}	20 to 98 {0.2 to 1.0}	--	--	--	1530 {15.6}	950 {9.6}	680 {6.9}	380 {3.9}	
		160 {1.6}	20 to 98 {0.2 to 1.0}	--	--	--	1960 {20.0}	1700 {17.4}	1230 {12.5}	700 {7.0}	
		390 {4.0}	80 to 240 {0.8 to 2.4}	--	--	--	--	--	--	1960 {20.0}	

- Note) 1. In the case of using positioners, please the setting of supply pressure with pressure regulator.  
 2. The maximum allowable differential pressures must not exceed the maximum working pressures specified by JISB2201-1984, ANSIB16.34-1981, and JPI-7S-65-831.

**Valve seat leakage, Class IV: 0.01% of the rated Cv value**

**Table 14. Model AGVM nominal size 1/2, 3/4 and 1 inch**

Air-to-open



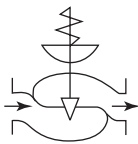
Nominal size (inch)	Actuator	Supply pressure kPa {kgf/cm <sup>2</sup> }	Spring range kPa {kgf/cm <sup>2</sup> }	Differential pressure (by Cv value) kPa {kgf/cm <sup>2</sup> }					
				0.1 0.16 0.25	0.4 0.63	1.0 1.6	2.5 4.0	6.3 8.0	10 14
1/2 3/4 1	PSA1R	140 {1.4}	20 to 98 {0.2 to 1.0}	1960 {20.0}		1650 {16.8}	1020 {10.4}	550 {5.6}	410 {4.2}
		270 {2.8}	80 to 240 {0.8 to 2.4}	5100 {52.0}	3120 {31.8}				
	PSA2R			140 {1.4}	20 to 98 {0.2 to 1.0}	--	1960 {20.0}		
		270 {2.8}	80 to 240 {0.8 to 2.4}	--	--	--	--		

- Note) 1. In the case of using positioners, please the setting of supply pressure with pressure regulator.  
 2. The maximum allowable differential pressures must not exceed the maximum working pressures specified by JISB2201-1984, ANSIB16.34-1981, and JPI-7S-65-831.  
 3. In the differential pressure column, upper figures show normal differential pressures and lower figures differential pressures when the valve is fully closed.

**Valve seat leakage, Class IV: 0.01% of the rated Cv value**

**Table 15. Model AGVM nominal size 1-1/2, 2, 2-1/2, 3 and 4 inches**

Air-to-open



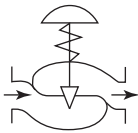
Nominal size (inch)	Actuator	Supply pressure kPa {kgf/cm <sup>2</sup> }	Spring range kPa {kgf/cm <sup>2</sup> }	Differential pressure (by port size (inch)) kPa{kgf/cm <sup>2</sup> }							
				1	1-1/4	1-1/2	2	2-1/2	3	4	
1-1/2 2	PSA1R	140 {1.4}	20 to 98 {0.2 to 1.0}	410 {4.2}	250 {2.6}	170 {1.8}	100 {1.1}	--	--	--	
		270 {2.8}	80 to 240 {0.8 to 2.4}	1960 {20.0}	1780 {18.2}	1210 {12.3}	720 {7.4}	--	--	--	
	PSA2R	140 {1.4}	20 to 98 {0.2 to 1.0}	800 {8.2}	490 {5.0}	330 {3.4}	200 {2.0}	--	--	--	
		270 {2.8}	80 to 240 {0.8 to 2.4}	1960 {20.0}			1400 {14.3}	--	--	--	
	PSA3R	140 {1.4}	20 to 98 {0.2 to 1.0}	1420 {14.5}	880 {8.9}	590 {6.1}	350 {3.6}	--	--	--	
		270 {2.8}	80 to 240 {0.8 to 2.4}	--	1960 {20.0}			--	--	--	
	PSA4R	140 {1.4}	20 to 98 {0.2 to 1.0}	1960 {20.0}	1510 {15.4}	1030 {10.5}	610 {6.2}	--	--	--	
		270 {2.8}	80 to 240 {0.8 to 2.4}	--	--	1960 {20.0}		--	--	--	
	2-1/2 3 4	PSA3R	140 {1.4}	20 to 98 {0.2 to 1.0}	--	--	590 {6.1}	350 {3.6}	220 {2.2}	160 {1.6}	--
			270 {2.8}	80 to 240 {0.8 to 2.4}	--	--	1960 {20.0}		1530 {15.6}	1100 {11.3}	620 {6.3}
		PSA4R	140 {1.4}	20 to 98 {0.2 to 1.0}	--	--	1030 {10.5}	610 {6.2}	380 {3.9}	270 {2.8}	150 {1.6}
			270 {2.8}	80 to 240 {0.8 to 2.4}	--	--	1960 {20.0}			1910 {19.4}	1070 {10.9}
PSA6R		260 {2.6}	100 to 180 {1.0 to 1.8}	--	--	--	1960 {20.0}			1450 {14.8}	
		400 {4.0}	200 to 340 {2.0 to 3.5}	--	--	--	1960 {20.0}			3050 {31.1}	

- Note)
1. In the case of using positioners, please the setting of supply pressure with pressure regulator.
  2. The maximum allowable differential pressures must not exceed the maximum working pressures specified by JISB2201-1984, ANSIB16.34-1981, and JPI-7S-65-831.
  3. In the differential pressure column, upper figures show normal differential pressures and lower figures differential pressures when the valve is fully closed.

**Valve seat leakage, Class IV: 0.01% of the rated Cv value**

**Table 16. Model AGVM nominal size 1/2, 3/4 and 1 inch**

Air-to-close



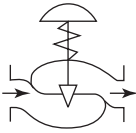
Nominal size (inch)	Actuator	Supply pressure kPa {kgf/cm <sup>2</sup> }	Spring range kPa {kgf/cm <sup>2</sup> }	Differential pressure (by Cv value) kPa{kgf/cm <sup>2</sup> }					
				0.1 0.16 0.25	0.4 0.63	1.0 1.6	2.5 4.0	8.0 6.3	10 14
1/2 3/4 1	PSA1D	140 {1.4}	20 to 98 {0.2 to 1.0}	1960 {20.0}			1380 {14.1}	1030 {10.5}	
				5100 {52.0}	4130 {42.1}	2550 {26.0}			
		160 {1.6}	20 to 98 {0.2 to 1.0}	1960 {20.0}			1860 {18.9}		
	5100 {52.0}			4590 {46.8}	2490 {25.4}				
	390 {4.0}	80 to 240 {0.8 to 2.4}	1960 {20.0}						
			5100 {52.0}						
PSA2D	140 {1.4}	20 to 98 {0.2 to 1.0}	--	--	1960 {20.0}				
			5100 {52.0}	4940 {50.3}	2680 {27.3}	2000 {20.4}			
	160 {1.6}	20 to 98 {0.2 to 1.0}	--	--	--	1960 {20.0}			
5100 {52.0}			4830 {49.2}	3600 {36.7}					

- Note)
1. In the case of using positioners, please the setting of supply pressure with pressure regulator.
  2. The maximum allowable differential pressures must not exceed the maximum working pressures specified by JISB2201-1984, ANSIB16.34-1981, and JPI-7S-65-831.
  3. In the differential pressure column, upper figures show normal differential pressures and lower figures differential pressures when the valve is fully closed.

**Valve seat leakage, Class IV: 0.01% of the rated Cv value**

**Table 17. Model AGVM nominal size 1-1/2, 2, 2-1/2, 3 and 4 inches**

Air-to-close



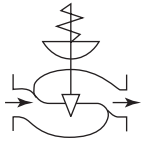
Nominal size (inch)	Actuator	Supply pressure kPa {kgf/cm <sup>2</sup> }	Spring range kPa {kgf/cm <sup>2</sup> }	Differential pressure (by port size (inch)) kPa{kgf/cm <sup>2</sup> }							
				1	1-1/4	1-1/2	2	2-1/2	3	4	
1-1/2	PSA1D	140 {1.4}	20 to 98 {0.2 to 1.0}	1030 {10.5}	640 {6.5}	430 {4.4}	260 {2.6}	--	--	--	
		160 {1.6}	20 to 98 {0.2 to 1.0}	1860 {18.9}	1150 {11.7}	780 {7.9}	460 {4.7}	--	--	--	
		390 {4.0}	80 to 240 {0.8 to 2.4}	1960 {20.0}			1500 {15.3}	--	--	--	
	PSA2D	140 {1.4}	20 to 98 {0.2 to 1.0}	2000 {20.0}	1230 {12.6}	840 {8.5}	500 {5.1}	--	--	--	
		160 {1.6}	20 to 98 {0.2 to 1.0}	1960 {20.0}		1510 {15.4}	900 {9.2}	--	--	--	
		390 {4.0}	80 to 240 {0.8 to 2.4}	--	1960 {20.0}			--	--	--	
	2	PSA3D	140 {1.4}	20 to 98 {0.2 to 1.0}	1960 {20.0}		1490 {15.1}	890 {9.0}	--	--	--
			160 {1.6}	20 to 98 {0.2 to 1.0}	3550 {36.2}	2190 {22.3}	1960 {20.0}		1600 {16.3}	--	--
			390 {4.0}	80 to 240 {0.8 to 2.4}	--	--	1960 {20.0}		--	--	--
		PSA4D	140 {1.4}	20 to 98 {0.2 to 1.0}	1960 {20.0}			1530 {15.6}	--	--	--
			160 {1.6}	20 to 98 {0.2 to 1.0}	--	--	1960 {20.0}		--	--	--
			390 {4.0}	80 to 240 {0.8 to 2.4}	--	--	1960 {20.0}		--	--	--
2-1/2	PSA3D	140 {1.4}	20 to 98 {0.2 to 1.0}	--	--	1490 {15.1}	890 {9.0}	550 {5.6}	390 {4.0}	220 {2.3}	
		160 {1.6}	20 to 98 {0.2 to 1.0}	--	--	1960 {20.0}	1600 {16.3}	990 {10.0}	710 {7.2}	400 {4.1}	
		390 {4.0}	80 to 240 {0.8 to 2.4}	--	--	1960 {20.0}				1290 {13.1}	
	PSA4D	140 {1.4}	20 to 98 {0.2 to 1.0}	--	--	1960 {20.0}	1530 {15.6}	950 {9.6}	680 {6.9}	380 {3.9}	
		160 {1.6}	20 to 98 {0.2 to 1.0}	--	--	1960 {20.0}		1700 {17.4}	1230 {12.5}	690 {7.0}	
		390 {4.0}	80 to 240 {0.8 to 2.4}	--	--	1960 {20.0}		1960 {20.0}			
3	PSA4D	140 {1.4}	20 to 98 {0.2 to 1.0}	--	--	4620 {47.1}	2760 {28.1}	5100 {52.0}	3180 {32.4}	2290 {23.3}	
		160 {1.6}	20 to 98 {0.2 to 1.0}	--	--	1960 {20.0}		1700 {17.4}	1230 {12.5}	690 {7.0}	
		390 {4.0}	80 to 240 {0.8 to 2.4}	--	--	1960 {20.0}		1960 {20.0}			
4	PSA4D	140 {1.4}	20 to 98 {0.2 to 1.0}	--	--	4620 {47.1}	2760 {28.1}	5100 {52.0}	3180 {32.4}	2290 {23.3}	
		160 {1.6}	20 to 98 {0.2 to 1.0}	--	--	1960 {20.0}		1700 {17.4}	1230 {12.5}	690 {7.0}	
		390 {4.0}	80 to 240 {0.8 to 2.4}	--	--	1960 {20.0}		1960 {20.0}			

- Note) 1. In the case of using positioners, please the setting of supply pressure with pressure regulator.  
 2. The maximum allowable differential pressures must not exceed the maximum working pressures specified by JISB2201-1984, ANSIB16.34-1981, and JPI-7S-65-831.  
 3. In the differential pressure column, upper figures show normal differential pressures and lower figures differential pressures when the valve is fully closed.

**Valve seat leakage, Class V and Class IV-S1: high shutoff model: metal seat**

**Table 18. Model AGVB nominal size 1/2, 3/4 and 1 inch**

Air-to-open

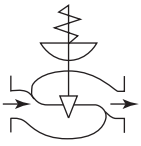


Nominal size (inch)	Actuator	Supply pressure kPa {kgf/cm <sup>2</sup> }	Spring range kPa {kgf/cm <sup>2</sup> }	Differential pressure (by Cv value) kPa{kgf/cm <sup>2</sup> }					
				0.1 0.16 0.25	0.4 0.63	1.0 1.6	2.5 4.0	6.3 8.0	10 14
1/2 3/4 1	PSA1R	270{2.8}	80 to 240 {0.8 to 2.4}	1960 {20.0}					

- Note) 1. In the case of using positioners, please the setting of supply pressure with pressure regulator.  
 2. The maximum allowable differential pressures must not exceed the maximum working pressures specified by JISB2201-1984, ANSIB16.34-1981, and JPI-7S-65-831.

**Table 19. Model AGVB nominal size 1-1/2, 2, 2-1/2, 3 and 4 inches**

Air-to-open

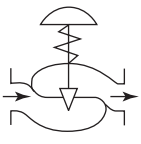


Nominal size (inch)	Actuator	Supply pressure kPa {kgf/cm <sup>2</sup> }	Spring range kPa {kgf/cm <sup>2</sup> }	Differential pressure (by port size (inch)) kPa{kgf/cm <sup>2</sup> }						
				1	1-1/4	1-1/2	2	2-1/2	3	4
1-1/2	PSA1R	270 {2.8}	80 to 240 {0.8 to 2.4}	1960 {20.0}	1110 {11.3}	660 {6.7}	270 {2.8}	--	--	--
	PSA2R	270 {2.8}	80 to 240 {0.8 to 2.4}	--	1960 {20.0}	1550 {15.8}	810 {8.2}	--	--	--
2	PSA3R	270 {2.8}	80 to 240 {0.8 to 2.4}	--	--	1960 {20.0}	1660 {16.9}	--	--	--
	PSA4R	270 {2.8}	80 to 240 {0.8 to 2.4}	--	--	--	1960 {20.0}	--	--	--
2-1/2	PSA3R	270 {2.8}	80 to 240 {0.8 to 2.4}	--	--	1960 {20.0}	1660 {16.9}	910 {9.3}	570 {5.8}	190 {2.0}
	PSA4R	270 {2.8}	80 to 240 {0.8 to 2.4}	--	--	--	1960 {20.0}	1790 {18.2}	1200 {12.3}	550 {5.6}
3	PSA6R	260 {2.6}	100 to 180 {1.0 to 1.8}	--	--	--	--	1960 {20.0}	1850 {18.9}	910 {9.3}
		400 {4.0}	200 to 340 {2.0 to 3.5}	--	--	--	--	--	--	1960 {20.0}

- Note) 1. In the case of using positioners, please the setting of supply pressure with pressure regulator.  
 2. The maximum allowable differential pressures must not exceed the maximum working pressures specified by JISB2201-1984, ANSIB16.34-1981, and JPI-7S-65-831.

**Table 20. Model AGVB nominal size 1/2, 3/4 and 1 inch**

Air-to-close



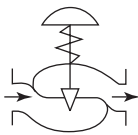
Nominal size (inch)	Actuator	Supply pressure kPa {kgf/cm <sup>2</sup> }	Spring range kPa {kgf/cm <sup>2</sup> }	Differential pressure (by Cv value) kPa{kgf/cm <sup>2</sup> }					
				0.1 0.16 0.25	0.4 0.63	1.0 1.6	2.5 4.0	6.3 8.0	10 14
1/2 3/4	PSA1D	160 {1.6}	20 to 98 {0.2 to 1.0}	1960 {20.0}				1640 {16.8}	1150 {11.7}
1		390 {4.0}	80 to 240 {0.8 to 2.4}	--	--	--	--	--	--
1	PSA2D	160 {1.6}	20 to 98 {0.2 to 1.0}	--	--	--	--	--	--

- Note) 1. In the case of using positioners, please the setting of supply pressure with pressure regulator.  
 2. The maximum allowable differential pressures must not exceed the maximum working pressures specified by JISB2201-1984, ANSIB16.34-1981, and JPI-7S-65-831.

**Valve seat leakage, Class V and Class IV-S1: high shutoff model: metal seat**

**Table 21. Model AGVB nominal size 1-1/2, 2, 2-1/2, 3, and 4 inches**

Air-to-close

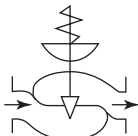


Nominal size (inch)	Actuator	Supply pressure kPa {kgf/cm <sup>2</sup> }	Spring range kPa {kgf/cm <sup>2</sup> }	Differential pressure (by port size (inch)) kPa{kgf/cm <sup>2</sup> }						
				1	1-1/4	1-1/2	2	2-1/2	3	4
1-1/2 2	PSA1D	160 {1.6}	20 to 98 {0.2 to 1.0}	1150 {11.7}	600 {6.1}	310 {3.2}	--	--	--	--
		390 {4.0}	80 to 240 {0.8 to 2.4}	1960 {20.0}		1100 {11.2}	--	--	--	
	PSA2D	160 {1.6}	20 to 98 {0.2 to 1.0}	--	1430 {14.6}	880 {9.0}	410 {4.1}	--	--	--
		390 {4.0}	80 to 240 {0.8 to 2.4}	--	--	--	1960 {20.0}	--	--	--
	PSA3D	160 {1.6}	20 to 98 {0.2 to 1.0}	1960 {20.0}		1790 {18.3}	950 {9.7}	--	--	--
	PSA4D	160 {1.6}	20 to 98 {0.2 to 1.0}	1960 {20.0}		--	1850 {18.9}	--	--	--
2-1/2 3 4	PSA3D	160 {1.6}	20 to 98 {0.2 to 1.0}	--	--	1790 {18.2}	950 {9.7}	470 {4.8}	260 {2.6}	--
		390 {4.0}	80 to 240 {0.8 to 2.4}	--	--	1960 {20.0}		1830 {18.7}	900 {9.2}	
	PSA4D	160 {1.6}	20 to 98 {0.2 to 1.0}	--	--	--	1850 {18.9}	1030 {10.5}	660 {6.7}	240 {2.5}
		390 {4.0}	80 to 240 {0.8 to 2.4}	--	--	--	--	--	1960 {20.0}	1780 {18.1}

- Note) 1. In the case of using positioners, please the setting of supply pressure with pressure regulator.  
 2. The maximum allowable differential pressures must not exceed the maximum working pressures specified by JISB2201-1984, ANSIB16.34-1981, and JPI-7S-65-831.

**Table 22. Model AGVM nominal size 1/2, 3/4 and 1 inch**

Air-to-open



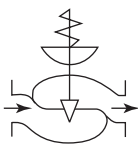
Nominal size (inch)	Actuator	Supply pressure kPa {kgf/cm <sup>2</sup> }	Spring range kPa {kgf/cm <sup>2</sup> }	Differential pressure (by Cv value) kPa{kgf/cm <sup>2</sup> }					
				0.1 0.16 0.25	0.4 0.63	1.0 1.6	2.5 4.0	6.3 8.0	10 14
1/2 3/4	PSA1R	270 {2.8}	80 to 240 {0.8 to 2.4}	1960 {20.0}					
				5100 {52.0}			2750 {28.0}	1980 {20.2}	
1	PSA2R	270 {2.8}	80 to 240 {0.8 to 2.4}	--	--	--	--	1960 {20.0}	4100 {41.8}
								5100 {52.0}	

- Note) 1. In the case of using positioners, please the setting of supply pressure with pressure regulator.  
 2. The maximum allowable differential pressures must not exceed the maximum working pressures specified by JISB2201-1984, ANSIB16.34-1981, and JPI-7S-65-831.  
 3. In the differential pressure column, upper figures show normal differential pressures and lower figures differential pressures when the valve is fully closed.

**Valve seat leakage, Class V and Class IV-S1: high shutoff model: metal seat**

**Table 23. Model AGVM nominal size 1-1/2, 2, 2-1/2, 3 and 4 inches**

Air-to-open

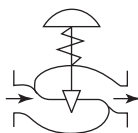


Nominal size (inch)	Actuator	Supply pressure kPa {kgf/cm <sup>2</sup> }	Spring range kPa {kgf/cm <sup>2</sup> }	Differential pressure (by port size (inch)) kPa{kgf/cm <sup>2</sup> }							
				1	1-1/4	1-1/2	2	2-1/2	3	4	
1-1/2 2	PSA1R	270 {2.8}	80 to 240 {0.8 to 2.4}	1960 {20.0}	1110 {11.3}	660 {6.7}	270 {2.8}	--	--	--	
				1980 {20.2}				--	--	--	
	PSA2R	270 {2.8}	80 to 240 {0.8 to 2.4}	1960{20.0}			1550 {15.8}	810 {8.2}	--	--	--
				4110 {41.9}	2420 {24.7}	--			--	--	
PSA3R	270 {2.8}	80 to 240 {0.8 to 2.4}	1960 {20.0}				1660 {16.9}	--	--	--	
			5100 {52.0}	4520 {46.1}	2970 {30.3}	--		--	--		
PSA4R	270 {2.8}	80 to 240 {0.8 to 2.4}	--	1960{20.0}			3080 {31.4}	--	--	--	
			5100 {52.0}			--		--	--		
2-1/2 3 4	PSA3R	270 {2.8}	80 to 240 {0.8 to 2.4}	--	--	1960 {20.0}	1660 {16.9}	910 {9.3}	570 {5.8}	190 {2.0}	
						2970 {30.3}					--
	PSA4R	270 {2.8}	80 to 240 {0.8 to 2.4}	--	--	1960{20.0}		1790 {18.2}	1200 {12.3}	550 {5.6}	
						5100 {52.0}	3080 {31.4}				--
PSA6R	260 {2.6}	100 to 180 {1.0 to 1.8}	--	--	--	--	1960 {20.0}	1850 {18.9}	910 {9.3}		
					2680 {27.3}	--	--				
		400 {4.0}	200 to 340 {2.0 to 3.5}	--	--	--	1960{20.0}				
							5100 {52.0}	4710 {48.0}	2520 {25.7}		

- Note) 1. In the case of using positioners, please the setting of supply pressure with pressure regulator.  
 2. The maximum allowable differential pressures must not exceed the maximum working pressures specified by JISB2201-1984, ANSIB16.34-1981, and JPI-7S-65-831.  
 3. In the differential pressure column, upper figures show normal differential pressures and lower figures differential pressures when the valve is fully closed.

**Table 24. Model AGVM nominal size 1/2, 3/4 and 1 inch**

Air-to-close



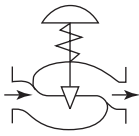
Nominal size (inch)	Actuator	Supply pressure kPa {kgf/cm <sup>2</sup> }	Spring range kPa {kgf/cm <sup>2</sup> }	Differential pressure (by Cv value) kPa{kgf/cm <sup>2</sup> }					
				0.1 0.16 0.25	0.4 0.63	1.0 1.6	2.5 4.0	6.3 8.0	10 14
1/2 3/4 1	PSA1D	160 {1.6}	20 to 98 {0.2 to 1.0}	1960{20.0}				1640 {16.8}	1150 {11.7}
				5100 {52.0}		3270 {33.3}			
		390 {4.0}	80 to 240 {0.8 to 2.4}	1960 {20.0}					
				5100 {52.0}					
		160 {1.6}	20 to 98 {0.2 to 1.0}	--	--	--	1960{20.0}		
				5100 {52.0}		3460 {35.3}	2500 {25.5}		

- Note) 1. In the case of using positioners, please the setting of supply pressure with pressure regulator.  
 2. The maximum allowable differential pressures must not exceed the maximum working pressures specified by JISB2201-1984, ANSIB16.34-1981, and JPI-7S-65-831.  
 3. In the differential pressure column, upper figures show normal differential pressures and lower figures differential pressures when the valve is fully closed.



**Valve seat leakage, Class V and Class IV-S1: high shutoff model: metal seat****Table 25. Model AGVM nominal size 1-1/2, 2, 2-1/2, 3 and 4 inches**

Air-to-close



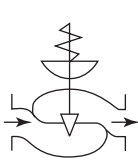
Nominal size (inch)	Actuator	Supply pressure kPa {kgf/cm <sup>2</sup> }	Spring range kPa {kgf/cm <sup>2</sup> }	Differential pressure (by port size (inch)) kPa{kgf/cm <sup>2</sup> }							
				1	1-1/4	1-1/2	2	2-1/2	3	4	
1-1/2 2	PSA1D	160 {1.6}	20 to 98 {0.2 to 1.0}	1150 {11.7}	600 {6.1}	310 {3.2}	--	--	--	--	
		390 {4.0}	80 to 240 {0.8 to 2.4}	1960 {20.0}			1100 {11.2}	--	--	--	
	PSA2D	160 {1.6}	20 to 98 {0.2 to 1.0}	1960 {20.0}	1430 {14.6}	880 {9.0}	410 {4.1}	--	--	--	
		390 {4.0}	80 to 240 {0.8 to 2.4}	--	1960 {20.0}			--	--	--	
	PSA3D	160 {1.6}	20 to 98 {0.2 to 1.0}	1960 {20.0}		1790 {18.3}	950 {9.7}	--	--	--	
		390 {4.0}	80 to 240 {0.8 to 2.4}	--	--	1960 {20.0}		--	--	--	
	PSA4D	160{1.6}	20 to 98 {0.2 to 1.0}	1960 {20.0}			1850 {18.9}	--	--	--	
		390{4.0}	80 to 240 {0.8 to 2.4}	--	--	--	1960 {20.0}	--	--	--	
	2-1/2 3 4	PSA3D	160 {1.6}	20 to 98 {0.2 to 1.0}	--	--	1790 {18.2}	950 {9.7}	470 {4.8}	260 {2.6}	--
			390 {4.0}	80 to 240 {0.8 to 2.4}	--	--	1960 {20.0}			1830 {18.7}	900 {9.2}
		PSA4D	160 {1.6}	20 to 98 {0.2 to 1.0}	--	--	1960 {20.0}	1850 {18.9}	1030 {10.5}	660 {6.7}	240 {2.5}
			390 {4.0}	80 to 240 {0.8 to 2.4}	--	--	--	1960 {20.0}			1770 {18.0}
							5100 {52.0}	4490 {45.8}	2660 {27.1}		
							5100 {52.0}	4810 {49.1}	3380 {34.4}		

- Note) 1. In the case of using positioners, please the setting of supply pressure with pressure regulator.  
 2. The maximum allowable differential pressures must not exceed the maximum working pressures specified by JISB2201-1984, ANSIB16.34-1981, and JPI-7S-65-831.  
 3. In the differential pressure column, upper figures show normal differential pressures and lower figures differential pressures when the valve is fully closed.

**Valve seat leakage, Class VI: high shutoff model: soft seat**

**Table 26. Model AGVB nominal size 1/2, 3/4 and 1 inch**

Air-to-open

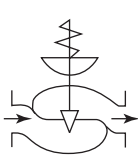


Nominal size (inch)	Actuator	Supply pressure kPa {kgf/cm <sup>2</sup> }	Spring range kPa {kgf/cm <sup>2</sup> }	Differential pressure (by Cv value) kPa{kgf/cm <sup>2</sup> }					
				0.1 0.16 0.25	0.4 0.63	1.0 1.6	2.5 4.0	6.3 8.0	10 14
1/2	PSA1R	270{2.8}	80 to 240 {0.8 to 2.4}	1960 {20.0}				1440 {14.7}	1030 {10.5}
3/4								1960 {20.0}	
1	PSA2R	270{2.8}	80 to 240 {0.8 to 2.4}	--	--	--	--	1960 {20.0}	

- Note) 1. In the case of using positioners, please the setting of supply pressure with pressure regulator.  
 2. The maximum allowable differential pressures must not exceed the maximum working pressures specified by JISB2201-1984, ANSIB16.34-1981, and JPI-7S-65-831.

**Table 27. Model AGVB nominal size 1-1/2, 2, 2-1/2, 3 and 4 inches**

Air-to-open

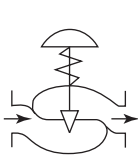


Nominal size (inch)	Actuator	Supply pressure kPa {kgf/cm <sup>2</sup> }	Spring range kPa {kgf/cm <sup>2</sup> }	Differential pressure (by port size (inch)) kPa{kgf/cm <sup>2</sup> }						
				1	1-1/4	1-1/2	2	2-1/2	3	4
1-1/2	PSA1R	270{2.8}	80 to 240 {0.8 to 2.4}	1030 {10.5}	460 {4.7}	190 {1.9}	--	--	--	--
	PSA2R	270{2.8}	80 to 240 {0.8 to 2.4}	1960 {20.0}	1740 {17.7}	1270 {13.0}	640 {6.5}	--	--	--
2	PSA3R	270{2.8}	80 to 240 {0.8 to 2.4}	--	1960 {20.0}		1580 {16.1}	--	--	--
	PSA4R	270{2.8}	80 to 240 {0.8 to 2.4}	--	--	--	1960 {20.0}	--	--	--
2-1/2	PSA3R	270{2.8}	80 to 240 {0.8 to 2.4}	--	--	1960 {20.0}	1580 {16.1}	960 {9.8}	640 {6.5}	280 {2.9}
	PSA4R	270{2.8}	80 to 240 {0.8 to 2.4}	--	--	--	1960 {20.0}	1920 {19.6}	1450 {14.8}	770 {7.9}

- Note) 1. In the case of using positioners, please the setting of supply pressure with pressure regulator.  
 2. The maximum allowable differential pressures must not exceed the maximum working pressures specified by JISB2201-1984, ANSIB16.34-1981, and JPI-7S-65-831.

**Table 28. Model AGVB nominal size 1/2, 3/4 and 1 inch**

Air-to-close



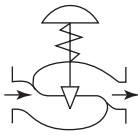
Nominal size (inch)	Actuator	Supply pressure kPa {kgf/cm <sup>2</sup> }	Spring range kPa {kgf/cm <sup>2</sup> }	Differential pressure (by Cv value) kPa{kgf/cm <sup>2</sup> }					
				0.1 0.16 0.25	0.4 0.63	1.0 1.6	2.5 4.0	6.3 8.0	10 14
1/2	PSA1D	140 {1.4}	20 to 98 {0.2 to 1.0}	1240 {12.6}	1240 {12.6}	690 {7.0}	110 {1.1}	--	--
		160 {1.6}	20 to 98 {0.2 to 1.0}	1960 {20.0}		1480 {15.1}	640 {6.5}	330 {3.4}	
3/4	PSA2D	390 {1.4}	80 to 240 {0.8 to 2.4}	--	--	--	1960 {20.0}		
1		140 {1.4}	20 to 98 {0.2 to 1.0}	1960 {20.0}		1910 {19.5}	1230 {12.5}	790 {8.1}	
	160 {1.6}	20 to 98 {0.2 to 1.0}	--	--	--	1960 {20.0}		1750 {17.8}	

- Note) 1. In the case of using positioners, please the setting of supply pressure with pressure regulator.  
 2. The maximum allowable differential pressures must not exceed the maximum working pressures specified by JISB2201-1984, ANSIB16.34-1981, and JPI-7S-65-831.

**Valve seat leakage, Class VI: high shutoff model: soft seat**

**Table 29. Model AGVB nominal size 1-1/2, 2, 2-1/2, 3, and 4 inches**

Air-to-close

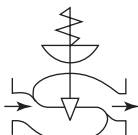


Nominal size (inch)	Actuator	Supply pressure kPa {kgf/cm <sup>2</sup> }	Spring range kPa {kgf/cm <sup>2</sup> }	Differential pressure (by port size (inch)) kPa{kgf/cm <sup>2</sup> }							
				1	1-1/4	1-1/2	2	2-1/2	3	4	
1-1/2 2	PSA1D	390 {4.0}	80 to 240 {0.8 to 2.4}	1960 {20.0}	1860 {19.0}	1390 {14.2}	730 {7.4}	--	--	--	
	PSA2D	140 {1.4}	20 to 98 {0.2 to 1.0}	790 {8.1}	310 {3.2}	--	--	--	--	--	
		160 {1.6}	20 to 98 {0.2 to 1.0}	1750 {17.8}	1170 {11.9}	680 {6.9}	280 {2.9}	--	--	--	
	PSA3D	390 {4.0}	80 to 240 {0.8 to 2.4}	--	1960 {20.0}		1860 {18.0}	--	--	--	
		140 {1.4}	20 to 98 {0.2 to 1.0}	1960 {20.0}	1410 {14.1}	880 {9.0}	400 {4.1}	--	--	--	
		160 {1.6}	20 to 98 {0.2 to 1.0}		1710 {17.4}	1050 {10.7}	--	--	--		
	PSA4D	390 {4.0}	80 to 240 {0.8 to 2.4}	--	--	--	1960 {20.0}	--	--	--	
		140 {1.4}	20 to 98 {0.2 to 1.0}	1960 {20.0}			1320 {13.5}	--	--	--	
	2-1/2 3 4	PSA3D	140 {1.4}	20 to 98 {0.2 to 1.0}	--	--	880 {9.0}	400 {4.1}	150 {1.5}	--	--
			160 {1.6}	20 to 98 {0.2 to 1.0}	--	--	1710 {17.4}	1050 {10.7}	550 {5.6}	340 {3.5}	110 {1.1}
390 {4.0}			80 to 240 {0.8 to 2.4}	--	--				1710 {17.4}	960 {9.8}	
PSA4D		140 {1.4}	20 to 98 {0.2 to 1.0}	--	--	1960 {20.0}	1320 {13.5}	730 {7.4}	470 {4.8}	190 {1.9}	
		160 {1.6}	20 to 98 {0.2 to 1.0}	--	--				1410 {14.4}	980 {10.0}	480 {4.9}
		390 {4.0}	80 to 240 {0.8 to 2.4}	--	--	--	--	1960 {20.0}		1820 {18.6}	

- Note) 1. In the case of using positioners, please the setting of supply pressure with pressure regulator.  
 2. The maximum allowable differential pressures must not exceed the maximum working pressures specified by JISB2201-1984, ANSIB16.34-1981, and JPI-7S-65-831.

**Table 30. Model AGVM nominal size 1/2, 3/4 and 1 inch**

Air-to-open



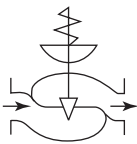
Nominal size (inch)	Actuator	Supply pressure kPa {kgf/cm <sup>2</sup> }	Spring range kPa {kgf/cm <sup>2</sup> }	Differential pressure (by Cv value) kPa{kgf/cm <sup>2</sup> }					
				0.1 0.16 0.25	0.4 0.63	1.0 1.6	2.5 4.0	6.3 8.0	10 14
1/2	PSA1R	270{2.8}	80 to 240 {0.8 to 2.4}	1960 {20.0}			1440 {14.7}		1030 {10.5}
3/4				2940 {30.0}		2850 {29.1}	2140 {21.8}		
1	PSA2R	270{2.8}	80 to 240 {0.8 to 2.4}	--	--	1960 {20.0}			
				2940 {30.0}		2450 {25.0}			

- Note) 1. In the case of using positioners, please the setting of supply pressure with pressure regulator.  
 2. The maximum allowable differential pressures must not exceed the maximum working pressures specified by JISB2201-1984, ANSIB16.34-1981, and JPI-7S-65-831.  
 3. In the differential pressure column, upper figures show normal differential pressures and lower figures differential pressures when the valve is fully closed.

**Valve seat leakage, Class VI: high shutoff model: soft seat**

**Table 31. Model AGVM nominal size 1-1/2, 2, 2-1/2, 3 and 4 inches**

Air-to-open

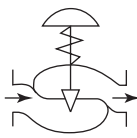


Nominal size (inch)	Actuator	Supply pressure kPa {kgf/cm <sup>2</sup> }	Spring range kPa {kgf/cm <sup>2</sup> }	Differential pressure (by port size (inch)) kPa {kgf/cm <sup>2</sup> }						
				1	1-1/4	1-1/2	2	2-1/2	3	4
1-1/2 2	PSA1R	270{2.8}	80 to 240 {0.8 to 2.4}	1030 {10.5}	460 {4.7}	180 {0.17}	--	--	--	--
	PSA2R	270{2.8}	80 to 240 {0.8 to 2.4}	1960 {20.0}	1740 {17.7}	1270 {13.0}	640 {6.5}	--	--	--
				2450 {25.0}						
	PSA3R	270{2.8}	80 to 240 {0.8 to 2.4}	1960 {20.0}			1580 {16.1}	--	--	--
2940 {30.0}				2370 {24.2}						
PSA4R	270{2.8}	80 to 240 {0.8 to 2.4}	--	--	1960 {20.0}		--	--	--	
2-1/2 3	PSA3R	270{2.8}	80 to 240 {0.8 to 2.4}	--	--	1960 {20.0}	1580 {16.1}	960 {9.8}	640 {6.5}	280 {2.9}
				--	--	2370 {24.2}				
4	PSA4R	270{2.8}	80 to 240 {0.8 to 2.4}	--	--	1960 {20.0}		1920 {19.6}	1450 {14.8}	770 {7.9}
				--	--	2940 {30.0}	2.84 {29.0}			

- Note) 1. In the case of using positioners, please the setting of supply pressure with pressure regulator.  
 2. The maximum allowable differential pressures must not exceed the maximum working pressures specified by JISB2201-1984, ANSIB16.34-1981, and JPI-7S-65-831.  
 3. In the differential pressure column, upper figures show normal differential pressures and lower figures differential pressures when the valve is fully closed.

**Table 32. Model AGVM nominal size 1/2, 3/4 and 1 inch**

Air-to-close



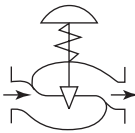
Nominal size (inch)	Actuator	Supply pressure kPa {kgf/cm <sup>2</sup> }	Spring range kPa {kgf/cm <sup>2</sup> }	Differential pressure (by Cv value) kPa {kgf/cm <sup>2</sup> }					
				0.1 0.16 0.25	0.4 0.63	1.0 1.6	2.5 4.0	6.3 8.0	10 14
1/2 3/4	PSA1D	140 {1.4}	20 to 98 {0.2 to 1.0}	1240 {12.6}	1240 {12.6}	690 {7.0}	110 {1.1}	--	--
		160 {1.6}	20 to 98 {0.2 to 1.0}	1960 {20.0}			1480 {15.1}	640 {6.5}	330 {3.4}
				2310 {23.6}	1980 {20.2}				
1	PSA2D	390 {4.0}	80 to 240 {0.8 to 2.4}	1960 {20.0}					
				2940 {30.0}			2620 {26.7}		
1	PSA2D	140 {1.4}	20 to 98 {0.2 to 1.0}	1960 {20.0}		2550 {26.0}	1900 {19.3}	1230 {12.6}	790 {8.1}
				2940 {30.0}	1960 {20.0}				
		160 {1.6}	20 to 98 {0.2 to 1.0}	2940 {30.0}			2140 {21.8}	1750 {17.9}	
390 {4.0}	80 to 240 {0.8 to 2.4}			--	--	--			--
									2940 {30.0}

- Note) 1. In the case of using positioners, please the setting of supply pressure with pressure regulator.  
 2. The maximum allowable differential pressures must not exceed the maximum working pressures specified by JISB2201-1984, ANSIB16.34-1981, and JPI-7S-65-831.  
 3. In the differential pressure column, upper figures show normal differential pressures and lower figures differential pressures when the valve is fully closed.

**Valve seat leakage, Class VI: high shutoff model: soft seat**

**Table 33. Model AGVM nominal size 1-1/2, 2, 2-1/2, 3 and 4 inches**

Air-to-close



Nominal size (inch)	Actuator	Supply pressure kPa {kgf/cm <sup>2</sup> }	Spring range kPa {kgf/cm <sup>2</sup> }	Differential pressure (by port size (inch)) kPa{kgf/cm <sup>2</sup> }								
				1	1-1/4	1-1/2	2	2-1/2	3	4		
1-1/2 2	PSA1D	160 {1.6}	20 to 98 {0.2 to 1.0}	330 {3.4}	--	--	--	--	--	--	--	
		390 {4.0}	80 to 240 {0.8 to 2.4}	1960 {20.0} 2620 {26.7}	1860 {18.9}	1390 {14.2}	730 {7.4}	--	--	--		
	PSA2D	140 {1.4}	20 to 98 {0.2 to 1.0}	790 {8.1}	310 {3.2}	--	--	--	--	--		
		160 {1.6}	20 to 98 {0.2 to 1.0}	1750 {17.8}	1170 {11.9}	680 {6.9}	280 {2.9}	--	--	--		
		390 {4.0}	80 to 240 {0.8 to 2.4}	1960 {20.0} 2940 {30.0}		2780 {28.4}	1860 {19.0}	--	--	--		
	PSA3D	140 {1.4}	20 to 98 {0.2 to 1.0}	1990 {20.3}	1410 {14.4}	880 {9.0}	400 {4.1}	--	--	--		
		160 {1.6}	20 to 98 {0.2 to 1.0}	1960 {20.0} 2940 {30.0}		2290 {23.4}	1710 {17.4}	1050 {10.7}	--	--	--	
		390 {4.0}	80 to 240 {0.8 to 2.4}	--	--	1960 {20.0} 2940 {30.0}		--	--	--		
	PSA4D	140 {1.4}	20 to 98 {0.2 to 1.0}	1960 {20.0} 2940 {30.0}			2660 {27.1}	1990 {20.3}	1320 {13.5}	--	--	--
		160 {1.6}	20 to 98 {0.2 to 1.0}	--	1960 {20.0} 2940 {30.0}			1990 {21.3}	--	--	--	
	2-1/2 3 4	PSA3D	140 {1.4}	20 to 98 {0.2 to 1.0}	--	--	880 {9.0}	400 {4.1}	150 {1.5}	--	--	
			160 {1.6}	20 to 98 {0.2 to 1.0}	--	--	1710 {17.4}	1050 {10.7}	550 {5.6}	340 {3.5}	110 {1.1}	
390 {4.0}			80 to 240 {0.8 to 2.4}	--	--	1960 {20.0} 2940 {30.0}		2250 {22.9}	1710 {17.4}	960 {9.8}		
PSA4D		140 {1.4}	20 to 98 {0.2 to 1.0}	--	--	1990 {20.3}	1320 {13.5}	730 {7.4}	470 {4.8}	190 {1.9}		
		160 {1.6}	20 to 98 {0.2 to 1.0}	--	--	1960 {20.0} 2940 {30.0}		2090 {21.3}	1410 {14.4}	980 {10.0}	480 {4.9}	
		390 {4.0}	80 to 240 {0.8 to 2.4}	--	--	--	--	1960 {20.0} 2940 {30.0}		1820 {18.6}		

- Note)
1. In the case of using positioners, please the setting of supply pressure with pressure regulator.
  2. The maximum allowable differential pressures must not exceed the maximum working pressures specified by JISB2201-1984, ANSIB16.34-1981, and JPI-7S-65-831.
  3. In the differential pressure column, upper figures show normal differential pressures and lower figures differential pressures when the valve is fully closed.

## 6. Accessories

### 6-1 Hand wheel

Use: The manual hand wheel enables you to open and close the valve manually.

Orientation: Side hand wheel, which is mounted to the yoke of the actuator.

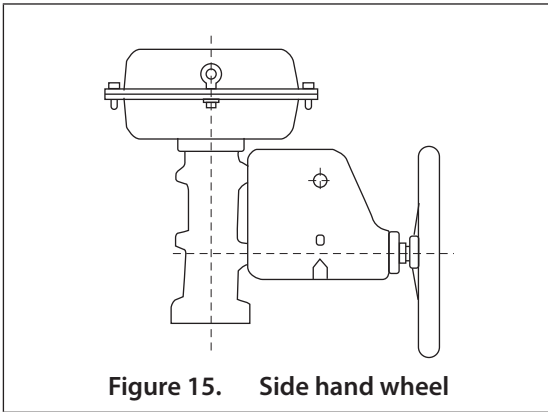


Figure 15. Side hand wheel

### 6-2 Positioner

Use: In response to input signals from the controller, the positioner controls the valve accurately and swiftly, switches between direct and reverse operation, and changes valve characteristics.

Models: According to input signals and applications, select one of the models shown below.

Input/Output signal	Type	Model
I/P	Smart valve positioner	AVP7_ _ _ AVP3_ _ _ AVP2_ _ _
P/P	Mechanical	HTP- _ _ VPE_ _ (Applied PSA1 only)

### 6-3 Pressure regulator with filter

Function: The Pressure regulator with filter reduce the pressure of application air, drains application air, and removes foreign substances.

Model: The model KZ03 is the standard

### 6-4 Booster relay

Function: The booster relay improves the working speed of the control valve.  
Use a booster relay that amplifies the output signals of the positioner.

Model: OEM products

### 6-5 Solenoid valve

Function: Electric signals make the solenoid valve to open and close the control valve.

Model: OEM products

### 6-6 Limit switch

Function: The limit switch converts the open and closed positions of the control valve into electric signals.

Model: The roller lever actuator is standard.

### 6-7 Lock-up valve

Function: In response to air pressure signals or in anticipations of fluctuations in the supply

Model: OEM products

## 7. Dimensions and weight

Table 34 and Table 35 show the dimensions and weight of the control valves. Note that the addition of any optional specifications will change their installed dimensions and weights.

**Table 34. Main dimensions**

Connection diameter (inch)	Actuator	Dimensions (mm)								
		A					H			φB
		JIS10K ANSI150 JPI150*1	JIS16K	JIS20K, 30K ANSI300 JPI300*1	JIS10K, 16K, 20K, 30K ANSI150, 300 JPI150, 300		Plain bonnet	Extension type I bonnet	Extension type II bonnet	
SW	BW									
1/2, 3/4	PSA1D, R	184	190	194	206	--	420	545	945	218
	PSA2D, R						450	575	975	267
1	PSA1D, R	184	193	197	210	--	420	545	945	218
	PSA2D, R						450	575	975	267
1-1/2	PSA1D, R	222	231	235	251	--	420	605	945	218
	PSA2D, R						450	635	975	267
	PSA3D, R						630	760	1160	350
	PSA4D, R						680	815	1215	470
2	PSA1D, R	254	263	267	286	--	420	605	945	218
	PSA2D, R						450	635	975	267
	PSA3D, R						630	760	1160	350
	PSA4D, R						680	815	1215	470
2-1/2	PSA3D, R	276	288	292	--	311	675	800	1155	350
	PSA4D, R						725	855	1210	470
	PSA6R						1145	1275	--	470
3	PSA3D, R	298	313	317	--	337	675	800	1155	350
	PSA4D, R						725	855	1210	470
	PSA6R						1145	1275	1710	470
4	PSA3D, R	352	364	368	--	394	680	800	1155	350
	PSA4D, R						730	860	1210	470
	PSA6R						1150	1275	1710	470

Note) \*1 : Face-to-face dimintions conform to following standards.

- IEC 60534-3-1:2001

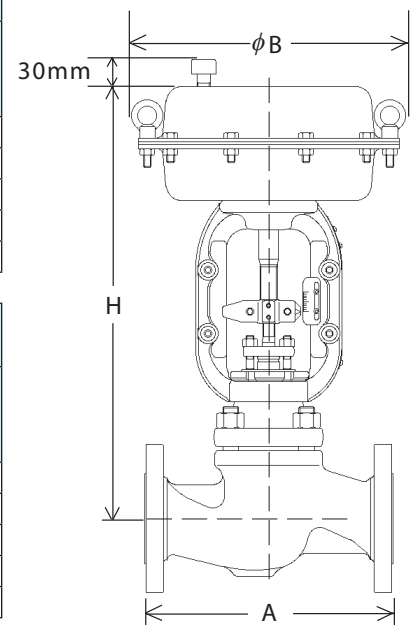
- JIS B 2005-3-1:2005

\*2 : H +135 mm for PSA6 with hand wheel.

**Table 35. Product weight (kg)**

Actuator	Body size (inch)	1/2		3/4		1		1-1/2	
	Pressure rating	JIS 10K ANSI 150 JPI 150	JIS 20K ANSI 300 JPI 300	JIS 10K ANSI 150 JPI 150	JIS 20K ANSI 300 JPI 300	JIS 10K ANSI 150 JPI 150	JIS 20K ANSI 300 JPI 300	JIS 10K ANSI 150 JPI 150	JIS 20K ANSI 300 JPI 300
PSA 1		15	16	16	19	17	19	27	32
PSA 2		18	19	19	22	20	22	30	35
PSA 3		--	--	--	--	--	--	50	55
PSA 4		--	--	--	--	--	--	68	73
PSA 6		--	--	--	--	--	--	--	--

Actuator	Body size (inch)	2		2-1/2		3		4	
	Pressure rating	JIS 10K ANSI 150 JPI 150	JIS 20K ANSI 300 JPI 300	JIS 10K ANSI 150 JPI 150	JIS 20K ANSI 300 JPI 300	JIS 10K ANSI 150 JPI 150	JIS 20K ANSI 300 JPI 300	JIS 10K ANSI 150 JPI 150	JIS 20K ANSI 300 JPI 300
PSA 1		30	33	--	--	--	--	--	--
PSA 2		33	36	--	--	--	--	--	--
PSA 3		53	56	71	77	73	81	89	106
PSA 4		71	74	89	95	91	99	107	124
PSA 6		--	--	190	197	192	201	208	225

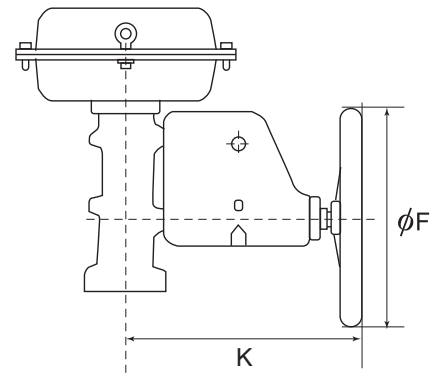


**Figure 16. Face-to-face dimensions and overall dimensions**

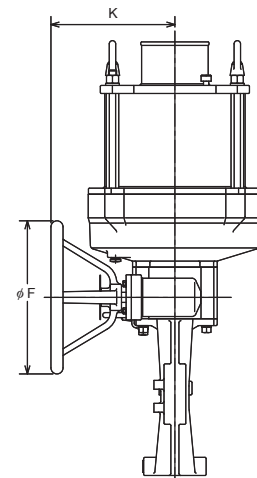
The overall dimensions and the valve weight will change when a manual hand wheel is mounted. In standard mounting, the position of operation of the side hand wheel is at the back of the actuator (on the side opposite that the valve positioner is mounted).

**Table 36. Hand wheel dimensions**

Type of hand wheel	Actuator	Dimension (mm)		Maximum driving force of hand wheel N (kgf)	Weight (kg)
		$\phi F$	K		
Side hand wheel	PSA1D, R	200	215	190 (19)	7
	PSA2D, R	200		320 (32)	
	PSA3D, R	355	345	650 (65)	27
	PSA4D, R	355		850 (85)	
	PSA6R	380	307	127 (13)	35



**Figure 17. Side hand wheel (PSA1~4)**

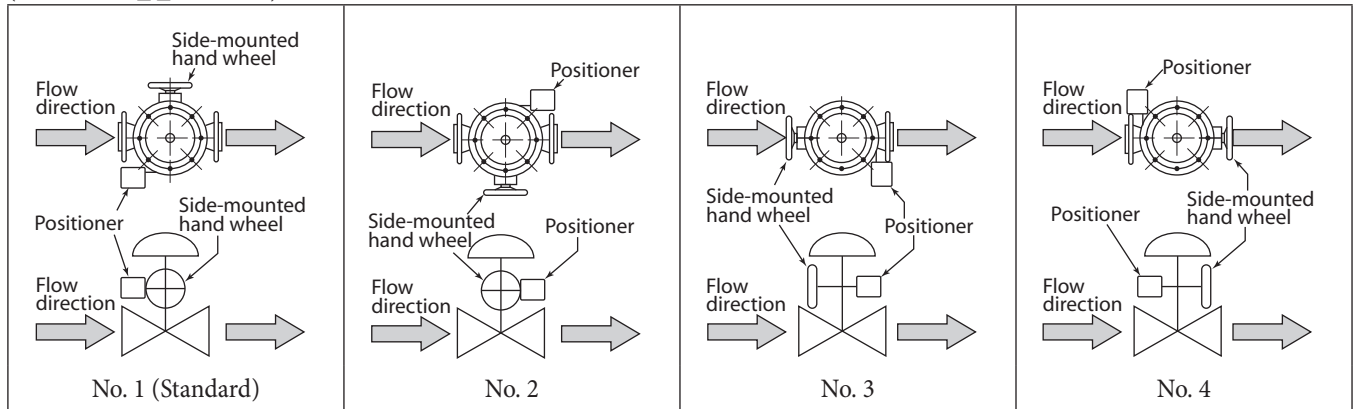


**Figure 18. Side hand wheel (PSA6R)**

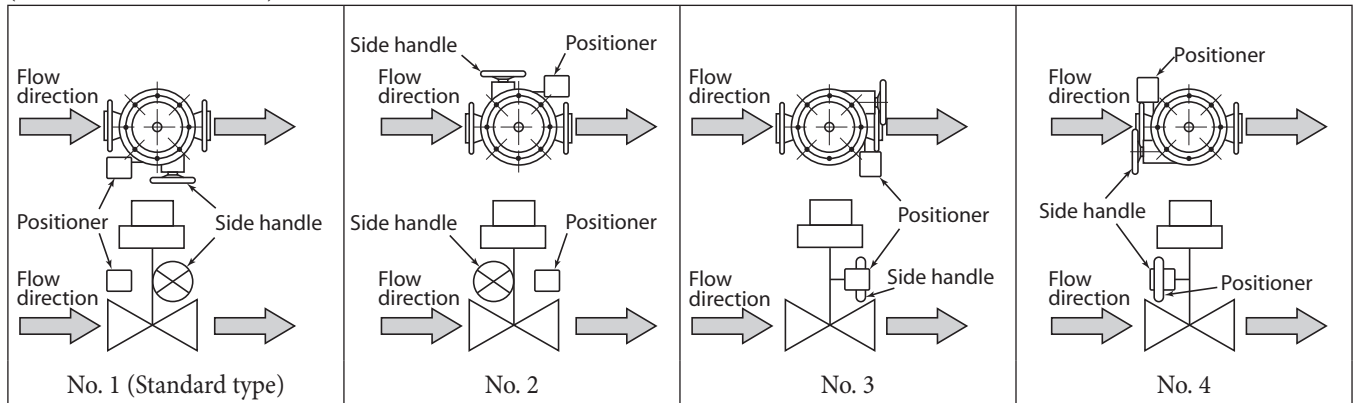


## 8. Actuator Orientation

(Model PSA\_\_ Actuator)



(Model PSA6R Actuator)



**Figure 19. Actuator orientation**

*Note) Indicate by position number when installation other than the standard type is required.*





Please read "Terms and Conditions" from the following URL  
before ordering and use.

<https://www.azbil.com/products/factory/order.html>

*Specifications are subject to change without notice.*

**azbil**

---

## Azbil Corporation

Advanced Automation Company

1-12-2 Kawana, Fujisawa  
Kanagawa 251-8522 Japan  
URL: <https://www.azbil.com/>

1st edition: June 1995  
14th edition: June 2019

*No part of this publication may be reproduced or duplicated  
without the prior written permission of Azbil Corporation.*