

# Control Motor

## Model ECM3000

### Overview

Model ECM3000 is a control motor designed for various industrial equipment applications.

Two models are available: 90° angular stroke motor for applications such as burner controls and 160° angular stroke motor for valve controls of hot and cold water or steam. Three kinds of control signal input types are available: relay contact, 4 to 20 mA DC, and potentiometer.

Three kinds of power supply voltage types are available: 24 V AC, 100 V AC and 200 V AC. Additionally, a power supply unit applicable to a voltage range of 85 to 264 V AC is also available for the 4 to 20 mA DC input type. Model ECM3000 contains a standard bracket accessory for retrofitting Azbil's older motors.

### Features

- Robust aluminum die-cast body.  
Long life parts are used for the internal potentiometers and bearings of the motor.
- Input is selectable - 3 input types. (According to model No.)  
Relay contact, 4 to 20 mA DC and potentiometer.
- The 90° angular stroke motor type has a pointer to indicate the position of the rotating shaft and a rotating direction label.
- Four optional auxiliary switches are available with the 90° angular stroke motor type.
- For both 90° and 160° angular stroke motors, models with two auxiliary switches and forced opening/closing function are also available.
- Splash-proof structure IP54 or equivalent, superior to environment resistance.
- Motor mounting bracket (standard accessory part) is compatible to replacing from Azbil's older motor being used at present.
- Two angular strokes available for several applications. 90° type and 160° type
- Output torque is 12.5 N·m.
- A CE-marked and cUL-certified product (24 V AC model only).



## Model selection guide

Model number	Supply power	Input signal	Angle of rotation	Motor timing		Output torque	Power consumption	Notes	UL marking *1	CE marking *1							
				50 Hz	60 Hz												
ECM3000D01 __	24 V AC	Relay contact	90°	39 s	33 s	12.5 N·m	9 VA *4	ON/OFF action	✓	✓							
ECM3000D11 __	100 V AC								–	–							
ECM3000D21 __	200 V AC								–	–							
ECM3000E01 __	24 V AC	Potentiometer		160°	69 s				58 s	12.5 N·m	9 VA *4	Position proportional action	✓	✓			
ECM3000F01 __	24 V AC	Relay contact											✓	✓			
ECM3000F11 __	100 V AC												–	–			
ECM3000F21 __	200 V AC	–			–												
ECM3000G01 __ *2	24 V AC	4–20 mA DC			39 s				6 N·m				14 VA	14 W *5	Position proportional action (high-speed motor model)	✓	✓
ECM3000G91 __ *2	85–264 V AC															–	–
ECM3000F03 __	24 V AC	Relay contact	20 s			16 s	6 N·m	14 VA								–	✓
ECM3000D020 _	24 V AC	Relay contact	160°		69 s	58 s	12.5 N·m	9 VA *4	ON/OFF action				✓			✓	
ECM3000E020 _	24 V AC	Potentiometer											✓			✓	
ECM3000F020 _	24 V AC	Relay contact		✓						✓							
ECM3000F120 _	100 V AC			–	–												
ECM3000F220 _	200 V AC	–		–													
ECM3000G02 __ *2 *7	24 V AC	4–20 mA DC		72 s	6 N·m	14 VA				14 W *5	Position proportional action (high-speed motor model)	✓	✓				
ECM3000G92 __ *2 *7	85–264 V AC											–	–				
ECM3000F040 _	24 V AC	Relay contact										35 s	29 s	6 N·m	14 VA	–	✓

Example: ECM3000D01

- 0 (zero): not GB-compliant, C: GB-compliant
- 0 (zero): Without options \*3
- 3: 4 built-in auxiliary switches (for standard model. Contact current: 100 mA to 5 A [resistive load], 100 mA to 3 A [inductive load])
- 4: 2 built-in auxiliary switches (for standard model. Contact current: 100 mA to 5 A [resistive load], 100 mA to 3 A [inductive load]) with forced open/close function \*6
- 5: 4 built-in auxiliary switches (for low-current model. Contact current: 1 to 100 mA [inductive load, including inrush current])
- 6: 2 built-in auxiliary switches (for low-current model. Contact current: 1 to 100 mA [inductive load, including inrush current]) with forced open/close function \*6

\*1. GB-compliant models are not compliant with UL or CE standards.

\*2. Direct/reverse operation can be switched and zero point, span, and deadband can be adjusted. The device is adjusted at the factory with the direct operation setting. Readjustment is essential if the type of operation is switched.

\*3. An extension unit can be mounted.

\*4. Power consumption of the following models is 11 VA: ECM3000G014\_, ECM3000G016\_, ECM3000G024\_, ECM3000G026\_

\*5. Power consumption of the following models is 15 W: ECM3000G914\_, ECM3000G916\_, ECM3000G924\_, ECM3000G926\_

\*6. Selectable only for ECM3000G01\_, ECM3000G91\_, ECM3000G02\_, and ECM3000G92\_.

\*7. 4 built-in auxiliary switches models can not be selected.

Note: If it is necessary to transmit the status of the ECM3000 auxiliary switch to an Azbil Corporation burner controller (or Protectorelay controller), please select a standard model (a model with 3 or 4 as the 11th digit of the model number).

### Handling Precautions

- The high-speed motor type must be used within a duty ratio (operation ratio) of 40 %.
- Do not connect the ECM3000F model to a mechanical balancing relay (R9107A, R927C, etc.). Doing so might damage the control motor by applying excessive voltage to its potentiometer.
- If an ECM3000F model controls the actuator on the basis of the resistance between T and G or between T and Y of the feedback potentiometer, it might not function normally, depending on the connected controller. For details, contact an Azbil Corporation sales representative.
- Be sure to apply non-voltage wiring to terminals S, CONT, CW, and CCW of ECM3000 models with an forced opening/closing function. In some cases M744 and M7284 control motors take 24 V AC to terminals S, CONT, CW, and CCW. If one of these models is replaced with an ECM3000 with forced opening/closing function, be sure not to apply 24 V AC to these terminals, or else the circuits may burn out.
- With ECM3000F and ECM3000D models, be sure that the leak current from the snubber circuit used to protect the motor-driving element (relay, SSR) does not exceed the following (listed by power supply voltage):
  1. 100 V AC: 0.8 mA (RMS) max.
  2. 200 V AC: 0.4 mA (RMS) max.

## Specifications

	Item	Description	
Basic specifications	Operation mode (fixed according to model No.)	ON-OFF, position proportioning, or forced opening/closing	
	Input signal (fixed according to model No.)	Relay contact, 4 to 20 mA DC, potentiometer (nominal 135 Ω)	
	Feedback potentiometer Nominal value	135 Ω (combined resistance *1), 0.5 W	
	Potentiometer Max. applied voltage	5 V DC	
	Input impedance (for 4 to 20 mA DC input signal)	Equivalent of 125 Ω or less (at 20 mA) (receiving resistance 45 Ω + resistance in the overcurrent protection circuit)	
	Angular stroke (selectable by model No.)	90° or 160°	
	Motor timing	90° models: 39/33 s ±5 s (relay contact, no load, 50/60 Hz) 39 s ±5 s (85-64 V AC 50/60 Hz power, no load) 20/16 s ±3 s (relay contact, no load, 50/60 Hz, high-speed motor)	
		160° models: 69/58 s ±5 s (relay contact, no load, 50/60 Hz) 72 s ±10 s (85-264 V AC 50/60 Hz power, no load) 35/29 s ±3 s (relay contact, no load, 50/60 Hz, high-speed motor)	
	Output torque	12.5 N·m (high-speed motor type 6 N·m)	
	Power supply voltage (fixed according to model No.)	24 V AC ±15 % / 100 V AC ±10 % / 200 V AC ±10 % / 85 to 264 V AC. Frequency: 50/60 Hz	
	Power consumption (during operation)	9 VA (relay contact, potentiometer, 4 to 20 mA type) 11 VA (forced opening/closing function, 4 to 20 mA, 24 V AC type) 14 W (4 to 20 mA, 85 to 264 V AC type) 15 W (forced opening/closing function, 4 to 20 mA, 85 to 264 V AC type) 14 VA (high-speed motor type)	
	Protection	Splash-proof structure IP54 or equivalent when water-proof cable gland is used.	
	Material	Case: Die-cast aluminum Cover: Polycarbonate resin with GF Bracket: Steel	
Mass (weight)	Approx. 3 kg		
Standard operating conditions	Temperature	23 ±2 °C	
	Humidity	50 ±10 %RH	
Operating conditions	Ambient temperature	-20 to +60 °C	
	Ambient humidity	5 to 95 %RH (no condensation allowed)	
	Vibration resistance	4.9 m/s <sup>2</sup>	
Transportation/ storage conditions (packaged condition)	Temperature	-20 to +70 °C	
	Humidity	5 to 95 %RH (no condensation allowed)	
	Vibration resistance	19.6 m/s <sup>2</sup>	
Insulation resistance	Between power supply terminals and casing, and between input terminals and casing	5 MΩ or more by 500 V DC megger	
	Between auxiliary switch terminals and casing	20 MΩ or more by 500 V DC megger	
Dielectric strength	Between power supply terminals and casing, and between input terminals and casing	24 V AC type	500 V AC, 60 s
		100 V AC type	1200 V AC, 60 s
		200 V AC type	1500 V AC, 60 s
		85 to 264 V AC type	1500 V AC, 60 s
	Between auxiliary switch terminals and casing	1500 V AC, 60 s	
Auxiliary switch/ forced opening/ closing input (option)	Number of inputs	4 (2) Note: 2 inputs for models with forced opening/closing	
	Contact rating	Standard model.: 250 V AC, 100 mA to 5 A(resistive load), 100 mA to 3 A (inductive load) Low-current model.: 250 V AC, 1 to 100 mA(inductive load, including inrush current) If UL or CE compliance is required, the rating is 30 Vrms or 42.4 V AC.	
	Service life	Standard model: 50,000 cycles or more. Low-current model: 200,000 cycles or more.	
	Position at factory setting	For 90° angular stroke motors with built-in auxiliary switch, at factory settings. Close → Open (A, C): 9° ±5° Open → Close (B, D): 81° ±5°	
	Settable range	Output opening range of 5 to 95 %. However, it must be the internal area of end switches.	
	Repeatability	Less than ±3 %	
	Operation type	1 - 2 terminals: NO, 1 - 3 terminals: NC	
	Forced opening/closing input	Non-voltage contact Contact rating: 15 V DC min., 100 mA min. Contact resistance: 10 Ω max. (1 mA DC)	
Safety certification (24 V AC model only)	CE marking	EN55011, EN61000	
	cUL certification	cUL standard	

\*1. Feedback potentiometer output specifications  
 The feedback potentiometer of the ECM3000F is an equivalent circuit.  
 (See the diagram of the circuit with resistors connected in parallel.)  
 In the controller, the resistance of the feedback potentiometer is converted to voltage, which indicates the motor opening.  
 In other words, the resistance of the potentiometer is not directly used as an indicator of the control motor's angle of rotation. But by using combined resistors (1 kΩ + 180 Ω), the resistance is close to 135 Ω, which has been conventionally used in the industry.

The following are Azbil Corporation's products compatible with this motor: SDC35/36, SDC45/46, the SDC40 series, DMC10, Network Instrumentation Modules, RN748 Motor Driver  
 For other products, please contact the azbil Group.

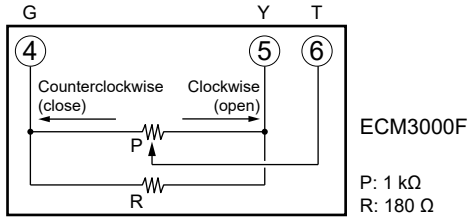

**Note**

The potentiometer of older models (M904, etc.) has a single resistor, so motor opening can be monitored by measuring the resistance of the potentiometer (between terminals G and T) with a tester. However, the feedback potentiometer of this control motor has multiple resistors, so the resistance is not proportional to the motor opening as it was in older models. The controller calculates the motor opening from the voltage between terminals G and T. The G-T voltage is linearly proportional to the motor opening, but the resistance measured between these terminals is not. Instead, the relationship of the resistance to the amount of opening can be graphed as a parabola, as shown below.

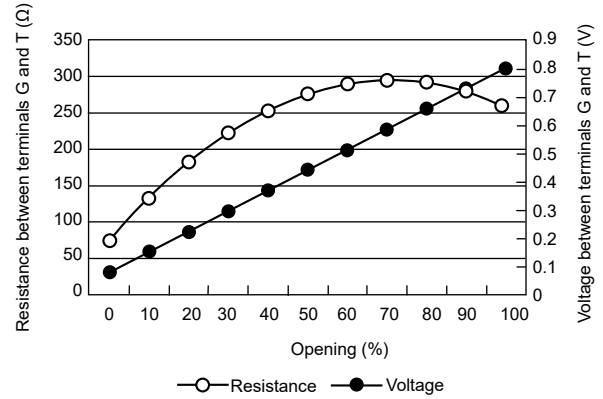

**Optional parts**

Name		Part No.
Crank arm		N-3128
Damper arm		J-26026G-ARM
Valve linkage *1		Q455C, D
Damper linkage		Q605A, D, E
Base kit for V51E		83165292-001
Waterproof connector		83104346-003
24 V AC power supply transformer		AT72-J1
Extension unit *2	Auxiliary switch (4 switches, contact current: 100 mA to 5 A)	83174065-002
	Auxiliary switch (4 switches, contact current: 1 to 100 mA)	83174065-102
	Auxiliary switch (4 switches, contact current: 100 mA to 5 A, GB-compliant) *3	83174065-003
	Auxiliary switch (4 switches, contact current: 1 to 100 mA, GB-compliant) *3	83174065-103
	Auxiliary potentiometer for 90° type *4	83165272-001
	Auxiliary potentiometer for 160° type *4	83165272-002

\*1 The linkage can be mounted on 160° stroke models.  
 \*2 Only one type of extension unit can be mounted on a model without an internal auxiliary switch.  
 \*3 If GB compliance is required, use this type of switch.  
 \*4 The total resistance of the auxiliary potentiometer is 1 kΩ ±10 %. The output of the auxiliary potentiometer cannot be connected to either an M904E Modutrol motor or to an ECM3000E control motor. Use the potentiometer for output to an external opening indicator or the like.

**Using a butterfly valve (V51E)**

If the ECM3000 is used with the V51E, mount the base kit (83165292-001, sold separately) between the V51E and the ECM3000.

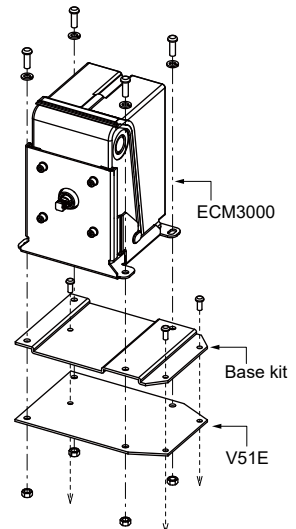

## Dimensions

(Unit: mm)

Angular stroke	A dimension	B dimension	C dimension
90° type	32.5	161.6	22
160° type	20.5	149.6	12

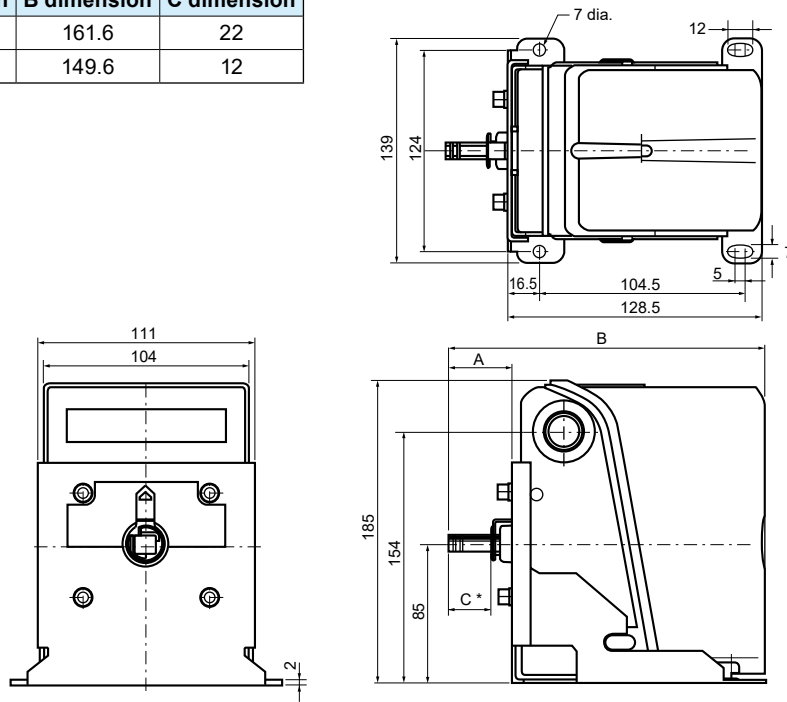

\* The C dimension shows the length of the output shaft (9.5 square).

- 0 % position of the output shaft (view from the output shaft)

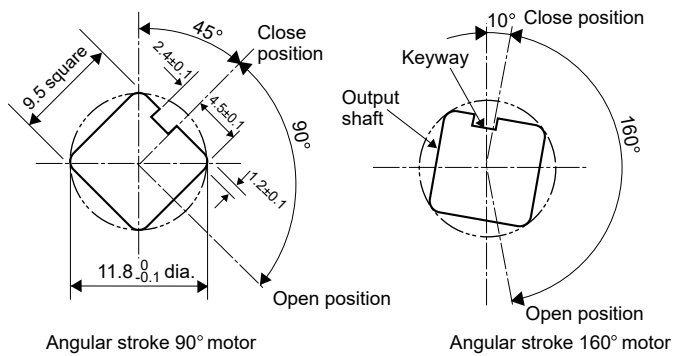

### ! Handling Precautions

- The length of the output shaft differs depending on the model number.  
On 90° models the pointer is attached.

## Mounting precautions

### ■ Mounting locations

Do not install the ECM3000 at locations shown below.

- Locations where hazardous chemicals, corrosive gas or briny/salty air exists.
- Locations where the ECM3000 is exposed to high temperatures.
- Locations where moisture or droplets exist.
- Locations where the ECM3000 is exposed to vibrations for a long period.
- Locations where the ECM3000 is exposed to direct sunlight.

Additionally, when installing the ECM3000 outdoors, an appropriate protective device such as protective cover must be installed.

### ⚠ Handling Precautions

Pay special attention so that any foreign matter or moisture content does not enter from the output shaft. In an application that the ECM3000 is combined with a control valve, such as fluid control, condensed moisture content is transferred from the valve and might enter the internals of the motor.

### ■ Mounting orientation

#### ● 90° stroke model

This model can be mounted with any desired orientation. However, take measures to prevent water and foreign matter from entering the output shaft.

#### ● 160° stroke model

This device can be mounted with the output shaft horizontal or facing downwards. To prevent water drops from entering the device, do not mount with the output shaft facing upward.

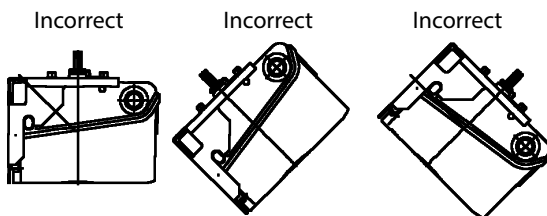

## Wiring

L : counterclockwise (CCW) rotation  
R : clockwise (CW) rotation

### ● Relay contact input (24 V AC power supply)

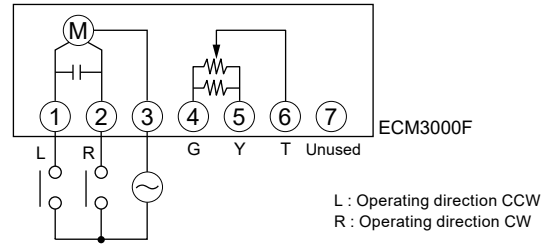

### ⚠ Handling Precautions

In using ON-OFF control action, terminal No. 4, 5 and 6 are not connected.

### ● Potentiometer (135 Ω) input (24 V AC power supply)

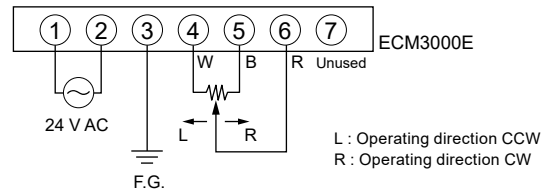

### ● 4 to 20 mA DC input (24 V AC power supply)

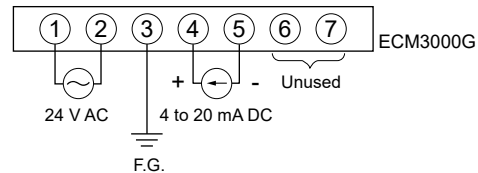

### ⚠ Handling Precautions

Terminals 2 and 5 are isolated from each other inside the motor.

### ● 4 to 20 mA DC input (85 to 264 V AC power supply)

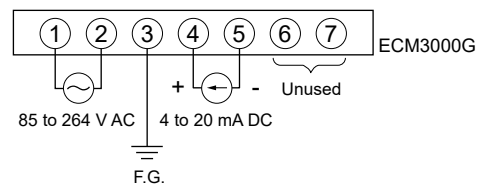

### ⚠ Handling Precautions

Terminals 2 and 5 are isolated from each other inside the motor.

● **Relay contact input (100 V AC/200 V AC power supply)**

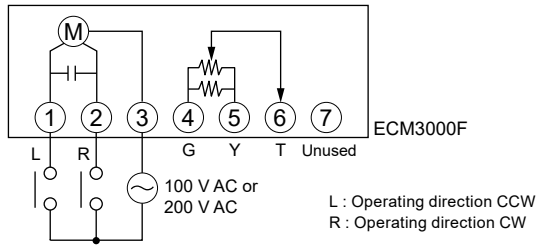

**! Handling Precautions**

- Set the parameters of the controller, (for example derivative time (D) is set to 0 second or dead band is widened), so that the internal relay of the controller does not repeat ON and OFF excessively due to hunting during motor operation. If the internal relay operates excessively, the life of the motor or the relay of the controller on the host side might be shortened. If frequent operation cannot be avoided, an auxiliary relay must be installed between the motor and the controller. The maximum allowable voltage to the feedback potentiometer is 5 V DC. Mechanical balancing relays (e.g., Azbil models R9107A, R927C, etc.) cannot be used.
- The feedback potentiometer of the ECM3000F has the combined resistance of two resistors connected in parallel. Accordingly, the rotation angle of the ECM3000F is proportional not to the resistance of the feedback potentiometer but to the voltage between the potentiometer terminals (T–G or Y–G voltage). The resistance of the feedback potentiometer cannot be used to measure the motor's angle of rotation.

● **Auxiliary switch (4 units)**

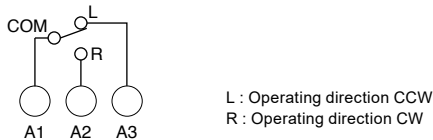

- Note:
- The connection of internal switches from B to D is same as the connection of A.
  - Models with forced opening/closing function have only A and B switches.

● **Forced opening/closing input**

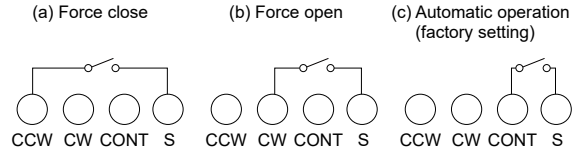

- Notes:
- At any one time, terminal S may be connected to only one of CCW, CW and CONT. Do not connect multiple terminals to terminal S.
  - Be sure to apply non-voltage wiring to terminals S, CONT, CW, and CCW of ECM3000 models with an forced opening/closing function. In some cases M744 and M7284 control motors take 24 V AC to terminals S, CONT, CW, and CCW. If one of these models is replaced with an ECM3000 with forced opening/closing function, be sure not to apply 24 V AC to these terminals, or else the circuits may burn out.
  - If the same contact signal is input to multiple control motors that are connected in parallel, faulty operation may result. Multiple ECM3000 motors cannot be synchronized by the same contact signal.

● **Full open/full close operation for ECM3000E**

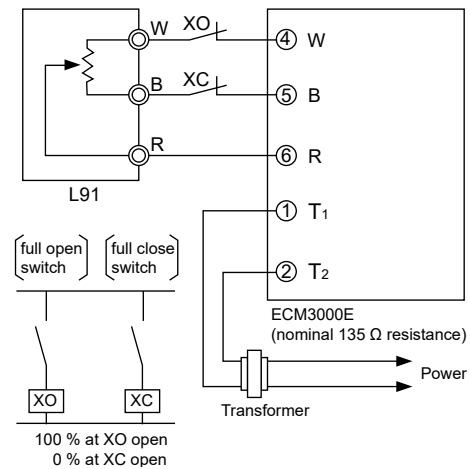

Please read "Terms and Conditions" from the following URL  
before ordering and use.  
<https://www.azbil.com/products/factory/order.html>

*Specifications are subject to change without notice.*

**azbil**

**Azbil Corporation**  
Advanced Automation Company

1-12-2 Kawana, Fujisawa  
Kanagawa 251-8522 Japan  
URL: <https://www.azbil.com/>

1st edition: July 2004  
8th edition: Oct. 2021

*No part of this publication may be reproduced or duplicated  
without the prior written permission of Azbil Corporation.*