



Fiber Unit Selection Guide

Model HPF- _ _ _ _



Please read "Terms and Conditions" from the following URL before ordering and use.
<https://www.azbil.com/products/factory/order.html>

Other product names, model numbers and company names may be trademarks of the respective company.

[Notice] Specifications are subject to change without notice.
No part of this publication may be reproduced or duplicated without the prior written permission of Azbil Corporation.

Azbil Corporation
Advanced Automation Company

Yamatake Corporation changed its name to Azbil Corporation on April 1, 2012.

1-12-2 Kawana, Fujisawa
Kanagawa 251-8522 Japan
URL: <https://www.azbil.com>

1st Edition : Jul. 2010-JBA
8th Edition : Apr. 2019-AZ

Extensive Product Lineup

Suitable for a Wide Variety of Applications

Table of Contents

Search by Type or Application

Select by Shape or Optical Type	Screw Most generally used. Use by attaching to a bracket, etc.  P.09	Cylindrical Suitable for installation where space is limited. Use by attaching with the setscrew.  P.13	Coaxial Used for target object positioning or in combination with spot lenses.  P.15
	Sleeve Use to maintain a small distance between target object and fiber unit in a limited space.  P.17	Side View Light emitted to the side. Use to maintain a small distance between target object and fiber unit in a limited space.  P.19	Narrow View Light spread minimized. Use in a place where light intrusion is undesirable.  P.21
	Flat/Vane Suitable for installation where space is limited. Attach directly to casing.  P.23	Limited Reflective Resistant to ambient influences. Use for target object detection in a limited area.  P.24	Area Wide light beam. Use for target object with varying detection positions, detection of meandering, etc.  P.25
	Heat-proof Resistant to high temperatures. Use in environments up to 350 °C.  P.27	Chemical-proof Protected with PFA tubing for excellent chemical resistance.  P.29	Vacuum-proof Usable in a vacuum. Cable length can be specified.  P.31
	Liquid Level Detection  P.33	Liquid Level Detection  P.35	Liquid Leak Detection  P.37
	Lens Unit Accessory  P.39	Long-distance Lens / Side View Unit  P.41	Other Accessories  P.42

Search by Model Number

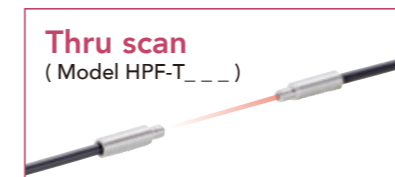

Model No.	Page
HPF-T001	09
T002	13
T003	09
T004	13
T005	17
T006	17
T007	19
T008	09
T009	13
T010	09
T012	27
T014	27
T015	17
T017	27
T018	27
T019	21
T020	21
T021	25
T021T	25
T021S	25
T021WT	25
T023	21
T024	09
T025	09
T025B	09
T026	19
T028	23
T029	29
T029E	29
T031	13
T032	35
T032E	35
T032E-L02	35
T033	09
T034	35
T034E	35
T034E-L02	35
T035	29
T036	13
T037	19
T038	13
T039	17
T042	19
T043	13
T044	09
T046	13
T054-L05	23
VT_	31

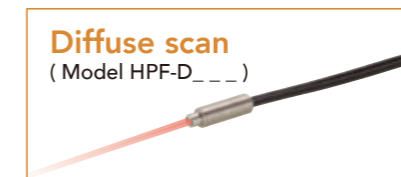

Model No.	Page
HPF-D001	11
D002	11
D003	17
D004	11
D005	13
D006	17
D009	15
D010	15
D011	19
D012	11
D013	27
D014	29
D015	27
D018	11
D019	17
D021	17
D022	27
D025	21
D026	25
D027	33
D028	24
D028F	24
D028T	24
D029	11
D030	11
D032	15
D032B	15
D033	33
D034	15
D035	15
D036	13
D037	11
D038	15
D039	17
D040	37
D041	19
D042	15
D043	19
D045LF	23
D049	15
VD_	31



Model No.	Page
FE-PA-F1	42
PA-L1	41
PA-S1	41
HPF-AT10	42
AT13	42
EU05	42
EU10	42
LU01	39
LU02	39
LU07	39
LU08	39
VA01	32
VJ03	32
VL05	32,41
VL06	32,41
HPX-PA06	42

- Screw
- Cylindrical
- Coaxial
- Sleeve
- Side View
- Narrow View
- Flat/Selective Reflection
- Area
- Heat-proof
- Chemical-proof
- Vacuum-proof
- Specialized Use
- Lens Unit
- Other Accessories

Technical Guide
List of Scanning Distance by Amplifiers Model

Introducing: Combination Amplifiers

Standard

Model HPX-EG00/01

<Exterior view>



<Operation panel>



Typical models

Type	Model No.
Standard	HPX-EG00-1S
Space-saving (main unit)	HPX-EG00-3S
Space-saving (expansion unit)	HPX-EG00-5S

- Double digital display
- Built for usability
(Sensitivity auto-change function, threshold value tracking function)

<Standards compliance>



Long-distance

Model HPX-EG50/51

<Exterior view>



<Operation panel>



Typical models

Type	Model No.
Standard	HPX-EG50-1S
Remote-tuning	HPX-EG51-1S

- Long-distance detection
- Double digital display
- Built for usability
(Sensitivity auto-change function, threshold value tracking function)

<Standards compliance>



Introducing: Fiber Customization Services

Change the cable length

If fiber length is insufficient, you can specify a cable length.*

<Example model number>

HPF-T001-L05

Base model number

L02: Fiber length 2 m
L05: Fiber length 5 m
L10: Fiber length 10 m

[Price] Determined by quantity

[Qty] No minimum (1 cable or more)

*For details on the scanning distances with a different cable length, see the Technical Guide (below on page 43).

*The cable cannot be lengthened on some models. For details, please contact our sales staff.

Change the sleeve length

Various on-site services are available, such as emergency sensor additions and changes, and sample production evaluation.

<Sample catalog entry>

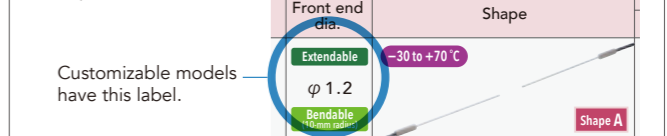

Applicable models

Thru scan	Diffuse scan
HPF-T005	HPF-D003
HPF-T015	HPF-D006
HPF-T037	HPF-D011

<Example model number> For an HPF-T005 with a 120 mm sleeve and 5 m fiber unit cable

[Price] Determined by quantity

「HPF-T005-S120L05」 is the model number.

The standard (base) model No.

"S" + 3-digit sleeve length.

Cable length. This can be omitted if length is standard.

Introducing: Element Types

[Material of element]

Plastic

[Performance/Feature]

General purpose

Bend-tolerant

Unbreakable

Heatproof

Multi-component glass

Heatproof

Vacuum

Two types, 200 °C and 350 °C

350 °C

<Sample catalog entry>

Cable		Amp
Bend radius	Length	
1 mm	2 m	HPX-EG00/
Unbreakable	Cuttable	HPX-EG50/

Indicates element type.

Bend-tolerant fiber unit (4 mm)

For use in moving environments



Cyclic bending test (reference)

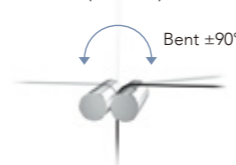

[Measurement conditions]

Roller diameter: 8 mm (4 mm in radius)
Load: 500 g
For example, Model HPF-T008 and -T009 withstand 1,000,000 bends under these conditions without breaking.

Unbreakable fiber unit (stationary bend type) (1 mm / 2 mm)

Even if the cable is bent at a small radius, the light level does not change.

Thanks to multi-core structure bundling several 100s of fiber elements, bending the cable does not attenuate the light level.

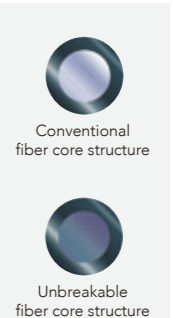

Conventional fiber core structure

Unbreakable fiber core structure

Application Case Studies



CASE 01 Liquid level detection Liquid Level Detection: p.33

[Type] Specialized Use (Thru scan)
[Catalog listing] HPF-D027, HPF-D033

■ Target object

Water

Reference data Received light level display value

Combination amplifiers: Model HPX-EG00/01 (Sensing model: nL3)

Catalog listing	Presence of liquid	Absence of liquid
HPF-D027	1000	120
HPF-D033	660	45

CASE 02 Liquid level detection Liquid Level Detection: p.35

[Type] Specialized Use (Thru scan)
[Catalog listing] HPF-T032_, HPF-T034_

■ Target object

Water

CASE 03 Liquid leak detection Liquid Leak Detection: p.37

[Type] Specialized Use (Diffuse scan)
[Catalog listing] HPF-D040

■ Target object

Water

Reference data Received light level display value

Combination amplifiers: Model HPX-EG00/01 (Sensing model: nL3)

Catalog listing	Presence of liquid	Absence of liquid	Sensor floating
HPF-D040	2950	650	450

CASE 04 Wafer projection detection Narrow View: p.21

[Type] Narrow View (Thru scan)
[Catalog listing] HPF-T020

■ Target object

Silicon wafer (300 mm)

CASE 05 Gold wire detection Coaxial: p.15

[Type] Coaxial (Diffuse scan)
[Catalog listing] HPF-D009

■ Target object

Gold wire (φ17 μm)

CASE 06 Lead frame detection Area: p.25

[Type] Area (Diffuse scan)
[Catalog listing] HPF-D026

■ Target object

Lead frame size 35 mm×150 mm

- Screw
- Cylindrical
- Coaxial
- Sleeve
- Side View
- Narrow View
- Flat/Selective Reflection
- Area
- Heat-proof
- Chemical-proof
- Vacuum-proof
- Specialized Use
- Lens Unit
- Other Accessories
- Technical Guide
- List of Scanning Distance by Amplifiers Model

Note: The possibility of detection, as well as the measurement performance and degree of accuracy, are affected by the actual working conditions. Before using the fiber unit, carry out a careful operation check.

Application Case Studies



CASE **07** | Chip face/back discrimination Coaxial: p.15
Micro-Spot Lens: p.39

[Type] Coaxial (Diffuse scan)/ Micro-Spot Lens
[Catalog listing] HPF-D034, HPF-LU07

■ Target object

(Front)

■ Target object

(Back) Target size 1 mm x 0.5 mm

Reference data Received light level display value

Combination amplifiers: Model HPX-EG50/51 (Sensing model: SF4)

Scanning distance	Front of component	Rear of component
-2 mm	280	270
-1 mm	570	390
Focal Distance	1700	1240
+1 mm	520	690
+2 mm	430	230

CASE **08** | Substrate "Bad" mark detection Coaxial: p.15
Micro-Spot Lens: p.39

[Type] Coaxial (Diffuse scan) / Micro-Spot Lens
[Catalog listing] HPF-D038, HPF-LU08

■ Target object

Gold pattern
Approx. 1 mm dia.

Reject mark
*The reject mark is applied to the gold pattern using an oil-based red felt pen.

CASE **09** | Detection of meandering Area: p.25

[Type] Area (Thru scan)
[Catalog listing] HPF-T021T_

■ Target object

Opaque Sheet

CASE **10** | Glass detection Screw: p.11

[Type] General-purpose screw (Diffuse scan)
[Catalog listing] Fiber: HPF-D002

■ Target object

Black mask

CASE **11** | Glass detection Selective Reflection: p.24

[Type] Selective reflection (Diffuse scan)
[Catalog listing] Fiber: HPF-D028T

■ Target object

Glass substrate

- Screw
- Cylindrical
- Coaxial
- Sleeve
- Side View
- Narrow View
- Flat/Selective Reflection
- Area
- Heat-proof
- Chemical-proof
- Vacuum-proof
- Specialized Use
- Lens Unit
- Other Accessories

Technical Guide
List of Scanning Distance by Amplifiers Model

Note: The possibility of detection, as well as the measurement performance and degree of accuracy, are affected by the actual working conditions. Before using the fiber unit, carry out a careful operation check.

Screw < Thru scan >

- Most generally used.
- Use by attaching to a bracket, etc.



Type	Size	Shape	Cable		Scanning distance (mm)			Core	Minimum detectable size (mm)	Model No.
			Bend radius	Length	Amp	Mode	Distance			
Straight	M3	Shape A	1 mm	2 m	HPX-EG00/01	nL	50	φ0.5	φ0.005	HPF-T024
					HPX-EG50/51	SF	42			
		HPX-EG00/01	FT	29						
		HPX-EG50/51	nL	110						
		HPX-EG00/01	HP	95						
		HPX-EG50/51	FT	41						
	M4	Shape C	4 mm	2 m	HPX-EG00/01	nL	60	4 × φ0.25	φ0.01	HPF-T008
					HPX-EG50/51	SF	50			
		HPX-EG00/01	FT	38						
		HPX-EG50/51	nL	140						
		HPX-EG00/01	HP	120						
		HPX-EG50/51	FT	50						
M3	Shape B	20 mm	2 m	HPX-EG00/01	nL	220	φ0.75	φ0.005	HPF-T044	
				HPX-EG50/51	SF	190				
	HPX-EG00/01	FT	130							
	HPX-EG50/51	nL	520							
	HPX-EG00/01	HP	450							
	HPX-EG50/51	FT	190							
Bolt	M4	Shape C	2 mm	2 m	HPX-EG00/01	nL	310	φ1.0	φ0.005	HPF-T025
					HPX-EG50/51	SF	260			
		HPX-EG00/01	FT	180						
		HPX-EG50/51	nL	700						
		HPX-EG00/01	HP	600						
		HPX-EG50/51	FT	260						
	M4	Shape D	20 mm	2 m	HPX-EG00/01	nL	410	φ1.0	φ0.005	HPF-T003
					HPX-EG50/51	SF	350			
		HPX-EG00/01	FT	240						
		HPX-EG50/51	nL	940						
		HPX-EG00/01	HP	800						
		HPX-EG50/51	FT	350						
M4	Shape E	20 mm	2 m	HPX-EG00/01	nL	770	φ1.4	φ0.01	HPF-T001	
				HPX-EG50/51	SF	650				
	HPX-EG00/01	FT	450							
	HPX-EG50/51	nL	1700							
	HPX-EG00/01	HP	1400							
	HPX-EG50/51	FT	630							
Elbow	M4	Shape F	4 mm	2 m	HPX-EG00/01	nL	280	16 × φ0.25	φ0.01	HPF-T033
					HPX-EG50/51	SF	240			
	HPX-EG00/01	FT	160							
	HPX-EG50/51	nL	700							
	HPX-EG00/01	HP	600							
	HPX-EG50/51	FT	260							
Bolt	M4	Shape E	2 mm	2 m	HPX-EG00/01	nL	310	φ1.0	φ0.005	HPF-T025B
					HPX-EG50/51	SF	260			
	HPX-EG00/01	FT	180							
	HPX-EG50/51	nL	700							
	HPX-EG00/01	HP	600							
	HPX-EG50/51	FT	260							
Elbow	M4	Shape F	20 mm	2 m	HPX-EG00/01	nL	300	φ1.0	φ0.005	HPF-T010
					HPX-EG50/51	SF	250			
	HPX-EG00/01	FT	170							
	HPX-EG50/51	nL	660							
	HPX-EG00/01	HP	570							
	HPX-EG50/51	FT	240							

Note:
 For scanning distances of the sensing modes, see the Technical Guide (page 47).
 Response times for the sensing types: HP 5 ms, nL 1 ms, SF 50 μs, and FT 250 μs.
 The values shown in the Minimum detectable size column were obtained with optimal scanning distance and sensitivity settings.

Outer dimensions (differs according to the model)

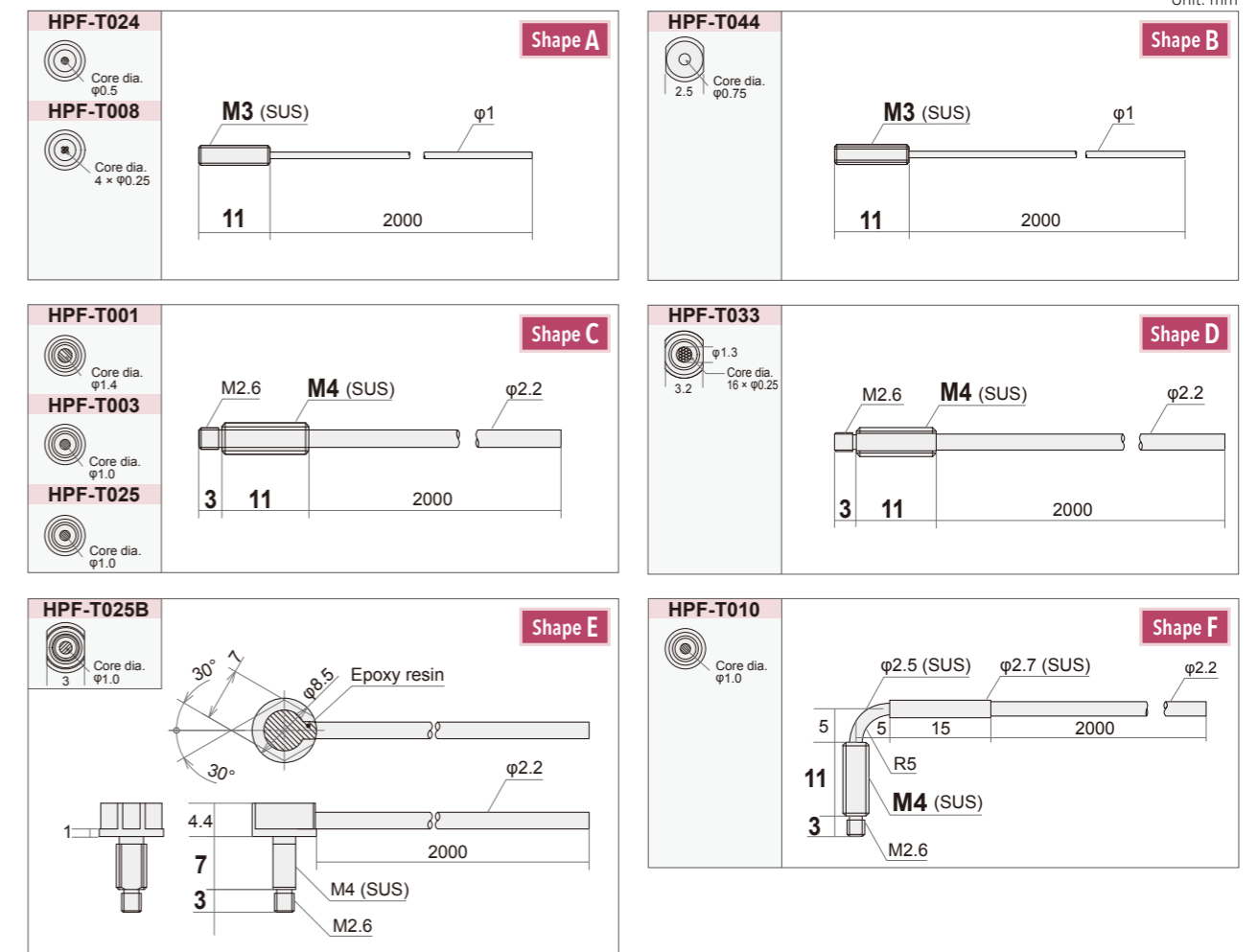

NOTEWORTHY

Products allowing either nut or setscrew installation are available for flexible operability, maintenance parts consolidation, and other considerations.

Model HPF-T025B

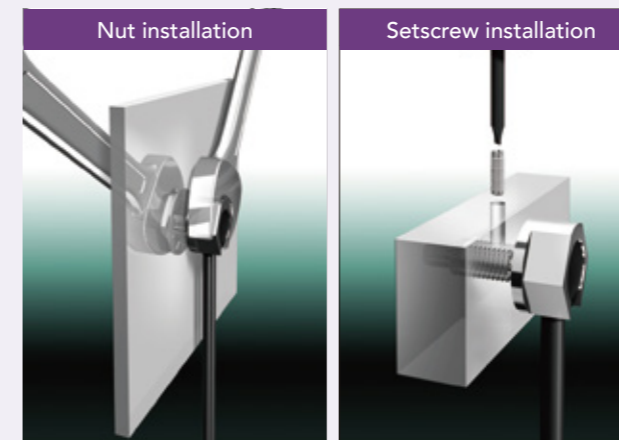

Attachment method selectable

Applicable model number

Form	Type	Model no.
Thru scan	Straight	HPF-T033
Thru scan	Straight	HPF-T044
Thru scan	Bolt	HPF-T025B

D-Shape

Screw < Diffuse scan >

- Most generally used.
- Use by attaching to a bracket, etc.



Related pages
For thru scan see page 9.

Diffuse scan

Type	Size	Shape	Cable		Scanning distance (mm)			Core	Minimum detectable size (mm)	Model No.
			Bend radius	Length	Amp	Mode	Distance			
Straight	M3	-30 to +70 °C Shape G	1 mm	2 m	HPX-EG00/01	nL: 10 SF: 8 Ft: 5	Receiver and emitter φ0.5	φ0.005	HPF-D029	
					HPX-EG50/51	nL: 22 SF: 19 Ft: 8				
					HPX-EG00/01	nL: 43 SF: 36 Ft: 25				
		-30 to +70 °C Shape H	15 mm	2 m	HPX-EG00/01	nL: 8 SF: 7 Ft: 5	Receiver and emitter 2×φ0.25	φ0.005	HPF-D004	
					HPX-EG50/51	nL: 17 SF: 15 Ft: 6				
					HPX-EG00/01	nL: 75 SF: 65 Ft: 46				
	M4	-30 to +70 °C Shape I	15 mm	2 m	HPX-EG00/01	nL: 85 SF: 70 Ft: 50	Receiver and emitter φ0.75	φ0.005	HPF-D018	
					HPX-EG50/51	nL: 170 SF: 150 Ft: 65				
	M6	-30 to +70 °C Shape J	2 mm	2 m	HPX-EG00/01	nL: 85 SF: 70 Ft: 50	Receiver and emitter φ1.0	φ0.005	HPF-D030	
					HPX-EG50/51	nL: 180 SF: 160 Ft: 70				
					HPX-EG00/01	nL: 100 SF: 80 Ft: 55				
		20 mm	2 m	HPX-EG50/51	nL: 220 SF: 190 Ft: 80	Receiver and emitter 16×φ0.25	φ0.005	HPF-D012		
HPX-EG00/01				nL: 210 SF: 180 Ft: 120						
HPX-EG50/51				nL: 470 SF: 400 Ft: 170						
20 mm	2 m	HPX-EG00/01	nL: 150 SF: 130 Ft: 90	Receiver and emitter φ1.0	φ0.005	HPF-D001				
		HPX-EG50/51	nL: 350 SF: 300 Ft: 130							
		HPX-EG00/01	nL: 150 SF: 130 Ft: 90							

Note:
 For scanning distances of the sensing modes, see the Technical Guide (page 48).
 Scanning distances for diffuse scan are obtained with a standard target object (plain white paper).
 Response times for the sensing types: HP 5 ms, nL 1 ms, SF 50 μs, and FT 250 μs.
 The values shown in the Minimum detectable size column were obtained with optimal scanning distance and sensitivity settings.

Outer dimensions (differs according to the model)

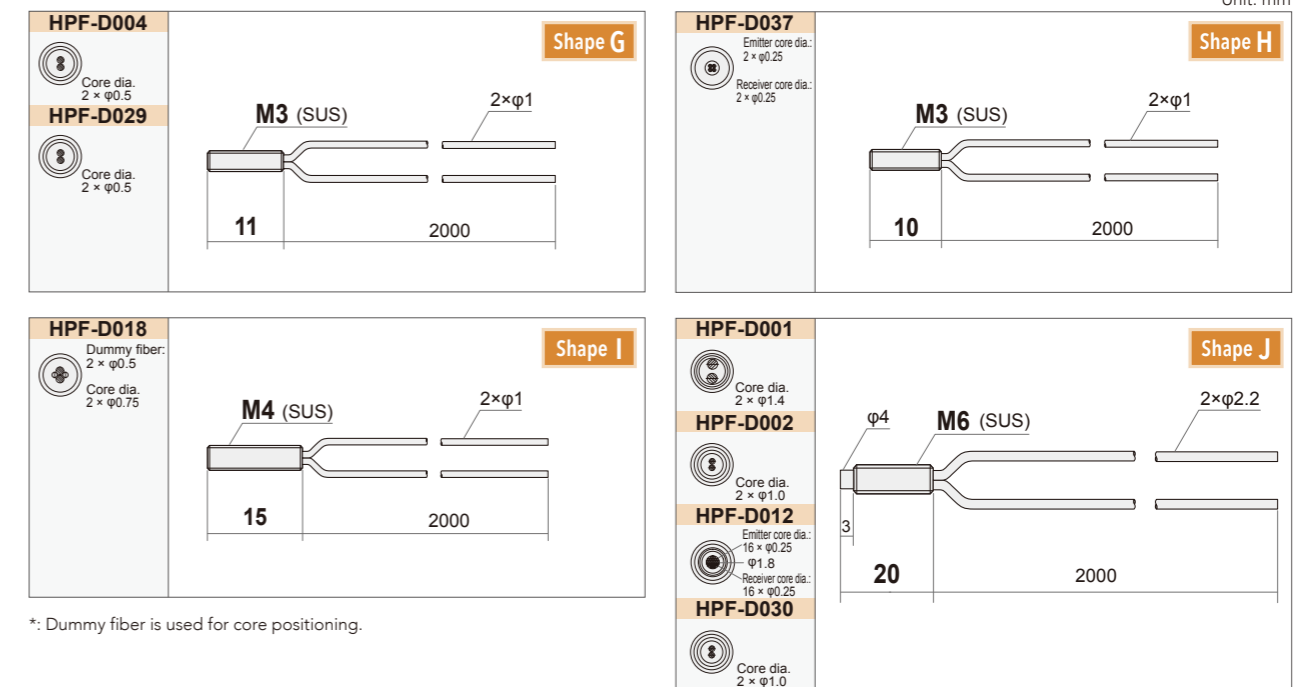

*: Dummy fiber is used for core positioning.

Screw

Cylindrical

Coaxial

Sleeve

Side View

Narrow View

Flat/Selective Reflection

Area

Heat -proof

Chemical -proof

Vacuum -proof

Specialized Use

Lens Unit

Other Accessories

Technical Guide

List of Scanning Distance by Amplifiers Model

Technical Guide

List of Scanning Distance by Amplifiers Model

Cylindrical

- Suitable for installation where space is limited.
- Use by attaching with the setscrew.

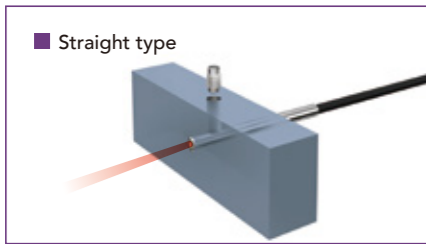

Related pages

Side-view sensors [P.19](#) Compatible lenses [P.41](#)

For head dia. of less than $\phi 1.0$ mm (thru scan) or $\phi 1.5$ mm (diffuse scan), select from sleeve-type sensors. [P.17](#)

Thru scan

Type	Size	Shape	Cable		Scanning distance (mm)			Core	Minimum detectable size (mm)	Model No.	
			Bend radius	Length	Amp	Mode	Distance				
Straight	$\phi 1$	Shape A	4 mm	0.5 m	HPX-EG00/01	nL 12 SF 10 Ft 7	2000	$\phi 0.25$	$\phi 0.005$	HPF-T038	
					HPX-EG50/51	nL 29 SF 25 Ft 10					
		Shape B	4 mm	2 m	HPX-EG00/01	nL 60 SF 50 Ft 38	2000	$4 \times \phi 0.25$	$\phi 0.01$		HPF-T009
					HPX-EG50/51	nL 140 SF 120 Ft 50					
	$\phi 1.5$	Shape C	4 mm	2 m	HPX-EG00/01	nL 60 SF 50 Ft 38	2000	$4 \times \phi 0.25$	$\phi 0.01$	HPF-T046	
					HPX-EG50/51	nL 140 SF 120 Ft 50					
		Shape D	4 mm	0.5 m	HPX-EG00/01	nL 6 SF 5 Ft 3	2000	$\phi 0.125$	$\phi 0.005$		HPF-T036
					HPX-EG50/51	nL 14 SF 12 Ft 5					
	$\phi 2$	Shape E	15 mm	2 m	HPX-EG00/01	nL 100 SF 80 Ft 55	2000	$\phi 0.5$	$\phi 0.005$	HPF-T043	
					HPX-EG50/51	nL 230 SF 200 Ft 85					
		Shape F	2 mm	2 m	HPX-EG00/01	nL 310 SF 260 Ft 180	2000	$\phi 1.0$	$\phi 0.005$		HPF-T031
					HPX-EG50/51	nL 700 SF 600 Ft 260					
$\phi 3$	Shape G	20 mm	2 m	HPX-EG00/01	nL 410 SF 350 Ft 240	2000	$\phi 1.0$	$\phi 0.005$	HPF-T004		
				HPX-EG50/51	nL 940 SF 800 Ft 350						
	Shape G	20 mm	2 m	HPX-EG00/01	nL 770 SF 650 Ft 450	2000	$\phi 1.4$	$\phi 0.01$		HPF-T002	
				HPX-EG50/51	nL 1700 SF 1400 Ft 630						

Diffuse scan

Type	Size	Shape	Cable		Scanning distance (mm)			Core	Minimum detectable size (mm)	Model No.
			Bend radius	Length	Amp	Mode	Distance			
Straight	$\phi 1.5$	Shape H	4 mm	1 m	HPX-EG00/01	nL 8 SF 7 Ft 5	2000	Receiver and emitter $2 \times \phi 0.25$	$\phi 0.005$	HPF-D036
					HPX-EG50/51	nL 17 SF 15 Ft 6				
Straight	$\phi 3$	Shape I	15 mm	2 m	HPX-EG00/01	nL 43 SF 36 Ft 25	2000	Receiver and emitter $\phi 0.5$	$\phi 0.005$	HPF-D005
					HPX-EG50/51	nL 90 SF 80 Ft 35				

Note:

For scanning distances of the sensing modes, see the Technical Guide (page 47–48).

Scanning distances for diffuse scan are obtained with a standard target object (plain white paper).

Response times for the sensing types: HP 5 ms, nL 1 ms, SF 50 μ s, and FT 250 μ s.

The values shown in the Minimum detectable size column were obtained with optimal scanning distance and sensitivity settings.

Outer dimensions (differs according to the model)

Unit: mm

HPF-T038 Shape A

HPF-T009 Shape B

HPF-T046 Shape C

HPF-T036 Shape D

HPF-T043 Shape E

HPF-T031 Shape F

HPF-T004 Shape G

HPF-D036 Shape H

HPF-D005 Shape I

NOTEWORTHY

- Smallest fiber unit head dia. (1.0 mm) in the industry

Model HPF-T038



- Compatible lens units are available for cylindrical types

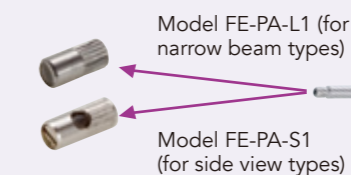

Model HPF-T004

Screw

Cylindrical

Coaxial

Sleeve

Side View

Narrow View

Flat/Selective Reflection

Area

Heat-proof

Chemical-proof

Vacuum-proof

Specialized Use

Lens Unit

Other Accessories

Technical Guide

List of Scanning Distance by Amplifiers Model

Coaxial

- Used for target object positioning or in combination with spot lenses.

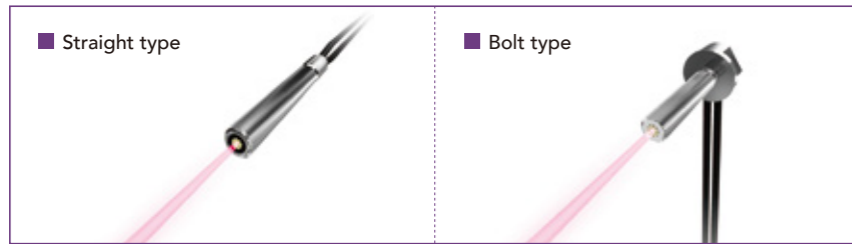

Related pages
For compatible micro-spot lenses
P.41

Diffuse scan

Type	Size	Shape	Cable		Scanning distance (mm)			Core	Minimum detectable size (mm)	Model No.	
			Bend radius	Length	Amp	Mode	Distance				
Straight	M3	Shape A Lens attachable -30 to +70 °C	4 mm	0.5 m	HPX-EG00/01	nL	25	Emitter: $\phi 0.25$ Receiver: $6 \times \phi 0.25$	$\phi 0.005$	HPF-D034	
						SF	21				
		HPX-EG50/51	HP	15							
		nL	50								
		SF	45								
	Shape B Lens attachable -30 to +70 °C	Emitter: 1 mm Receiver: 4 mm	2 m	HPX-EG00/01	nL	19	Emitter: $\phi 0.5$ Receiver: $4 \times \phi 0.25$	$\phi 0.005$	HPF-D032		
					SF	15					
					HPX-EG50/51	HP				10	
	Shape C Lens attachable -30 to +70 °C	4 mm	1 m	HPX-EG00/01	nL	18	Emitter: $\phi 0.5$ Receiver: $4 \times \phi 0.25$	$\phi 0.005$	HPF-D010		
					SF	15					
Bolt	M3	Shape D Lens attachable -30 to +70 °C	15 mm	2 m	HPX-EG00/01	nL	35	Emitter: $\phi 0.5$ Receiver: $4 \times \phi 0.25$	$\phi 0.005$	HPF-D049	
						SF	30				
		HPX-EG50/51	HP	21							
		nL	75								
		SF	65								
	Shape E Lens attachable -30 to +70 °C	Emitter: 1 mm Receiver: 4 mm	1 m	HPX-EG00/01	nL	28	Emitter: $\phi 0.5$ Receiver: $9 \times \phi 0.25$	$\phi 0.005$	HPF-D035		
					SF	21					
					HPX-EG50/51	HP				15	
	Straight	M4	Shape F Lens attachable -30 to +70 °C	15 mm	2 m	HPX-EG00/01	nL	55	Emitter: $\phi 0.5$ Receiver: $9 \times \phi 0.25$	$\phi 0.005$	HPF-D038
							SF	50			
HPX-EG50/51			HP	42							
nL			95								
SF			95								
Shape G Lens attachable -30 to +70 °C		20 mm	2 m	HPX-EG00/01	nL	43	Emitter: $\phi 1.0$ Receiver: $16 \times \phi 0.25$	$\phi 0.005$	HPF-D009		
					SF	29					
					HPX-EG50/51	HP				15	
$\phi 2$		Shape H Lens attachable -30 to +70 °C	15 mm	2 m	HPX-EG00/01	nL	50	Emitter: $\phi 0.5$ Receiver: $4 \times \phi 0.25$	$\phi 0.005$	HPF-D042	
						SF	42				
	HPX-EG50/51	HP	29								
	nL	150									
	SF	130									

Note:
For scanning distances of the sensing modes, see the Technical Guide (page 48).
Scanning distances for diffuse scan are obtained with a standard target object (plain white paper).
Response times for the sensing types: HP 5 ms, nL 1 ms, SF 50 μ s, and FT 250 μ s.
The values shown in the Minimum detectable size column were obtained with optimal scanning distance and sensitivity settings.

Outer dimensions (differs according to the model)

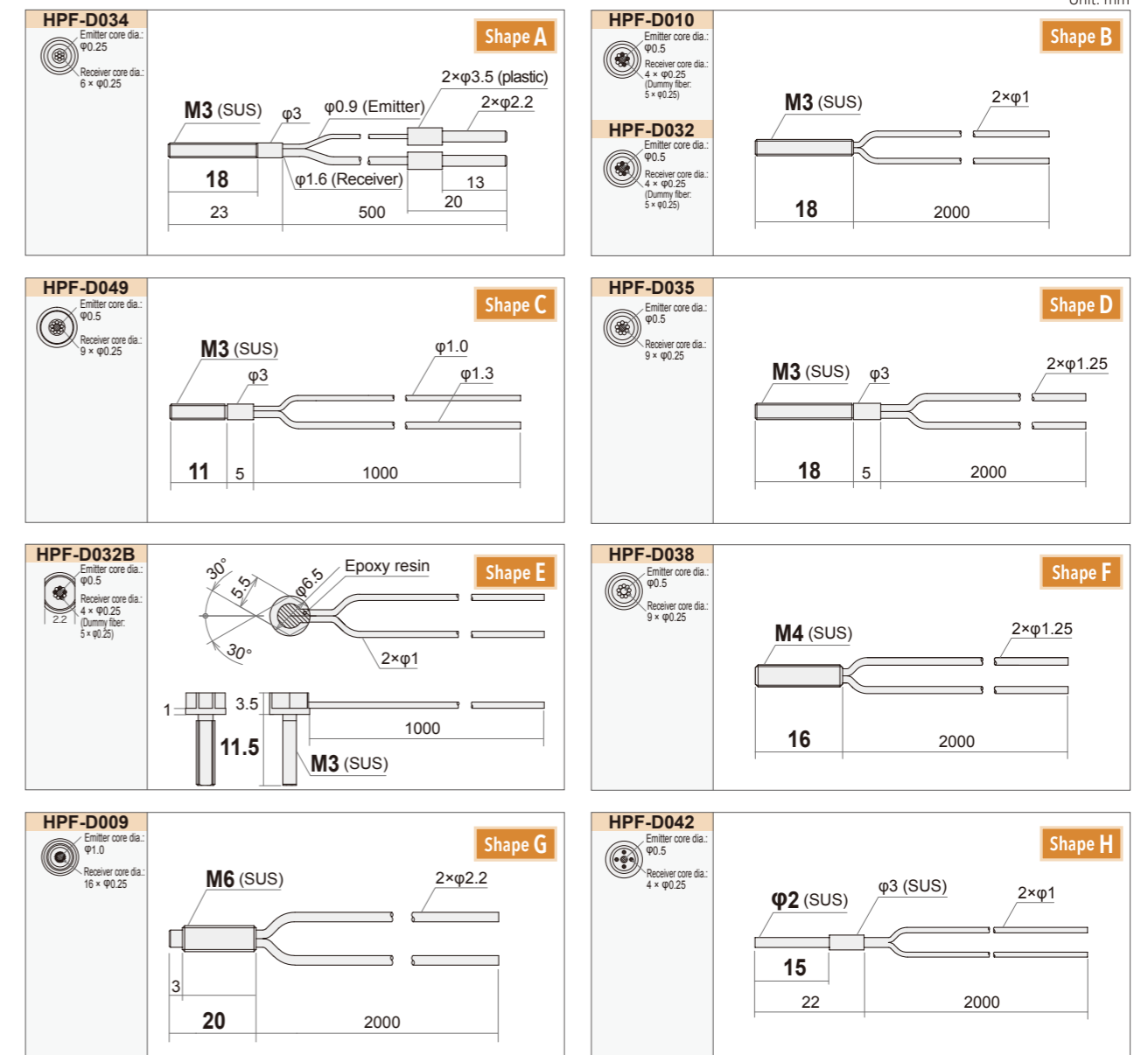

*: Dummy fiber is used for core positioning.

NOTEWORTHY

Coaxial fiber is recommended for use with micro-spot lenses and applications requiring highly precise positioning.

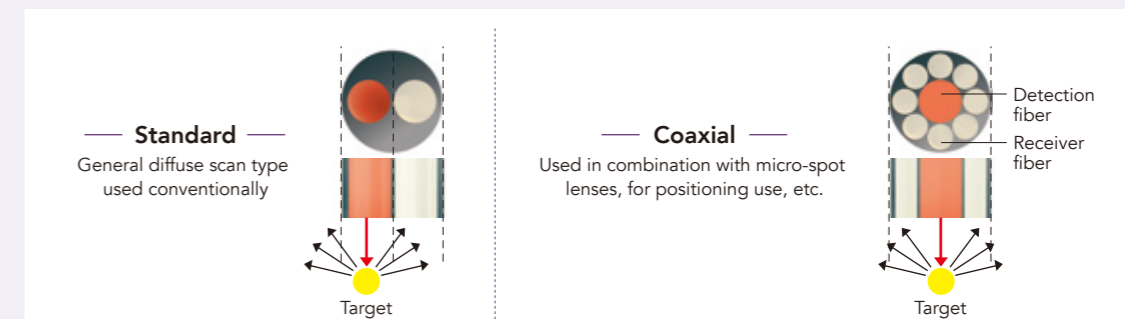

Screw

Cylindrical

Coaxial

Sleeve

Side View

Narrow View

Flat/Selective Reflection

Area

Heat-proof

Chemical-proof

Vacuum-proof

Specialized Use

Lens Unit

Other Accessories

Technical Guide

List of Scanning Distance by Amplifiers Model

Sleeve

- Use to maintain a small distance between target object and switch in a limited space.

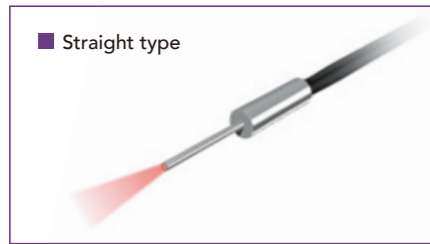

Related pages

Sleeve-length customization [P.04](#)

Side-view sensing [P.19](#)

Thru scan

Front end dia.	Shape	Cable		Scanning distance (mm)			Core	Minimum detectable size (mm)	Model No.
		Bend radius	Length	Amp	Mode	Distance			
φ 0.4		4 mm	0.5 m	HPX-EG00/01	nL: 6 SF: 5 Ft: 3	500	φ 0.125	φ 0.005	HPF-T039
				HPX-EG50/51	nL: 14 SF: 12 Ft: 5				
Extendable φ 0.5		15 mm	2 m	HPX-EG00/01	nL: 12 SF: 10 Ft: 7	2000	φ 0.25	φ 0.005	HPF-T015
				HPX-EG50/51	nL: 29 SF: 25 Ft: 10				
Extendable φ 1.2		20 mm	2 m	HPX-EG00/01	nL: 410 SF: 350 Ft: 240	500	φ 1.0	φ 0.005	HPF-T005
				HPX-EG50/51	nL: 940 SF: 800 Ft: 350				
Bendable (10-mm radius) φ 1.2		20 mm	0.5 m	HPX-EG00/01	nL: 410 SF: 350 Ft: 240	500	φ 1.0	φ 0.005	HPF-T006
				HPX-EG50/51	nL: 940 SF: 800 Ft: 350				

Diffuse scan

Front end dia.	Shape	Cable		Scanning distance (mm)			Core	Minimum detectable size (mm)	Model No.
		Bend radius	Length	Amp	Mode	Distance			
φ 0.82		4 mm	0.5 m	HPX-EG00/01	nL: 8 SF: 7 Ft: 5	500	Receiver and emitter φ 0.25	φ 0.005	HPF-D039
				HPX-EG50/51	nL: 18 SF: 16 Ft: 7				
φ 0.82		4 mm	0.5 m	HPX-EG00/01	nL: 8 SF: 7 Ft: 5	500	Receiver and emitter φ 0.25	φ 0.005	HPF-D019
				HPX-EG50/51	nL: 18 SF: 16 Ft: 7				
Extendable φ 1.2		15 mm	2 m	HPX-EG00/01	nL: 43 SF: 36 Ft: 25	2000	Receiver and emitter φ 0.5	φ 0.005	HPF-D006
				HPX-EG50/51	nL: 90 SF: 80 Ft: 35				
φ 1.5		15 mm	2 m	HPX-EG00/01	nL: 35 SF: 30 Ft: 21	2000	Receiver and emitter φ 0.5	φ 0.005	HPF-D021
				HPX-EG50/51	nL: 75 SF: 65 Ft: 28				
Extendable φ 2.5		20 mm	2 m	HPX-EG00/01	nL: 150 SF: 130 Ft: 90	2000	Receiver and emitter φ 1.0	φ 0.005	HPF-D003
				HPX-EG50/51	nL: 350 SF: 300 Ft: 130				

Note:

For scanning distances of the sensing modes, see the Technical Guide (page 47-48).

Scanning distances for diffuse scan are obtained with a standard target object (plain white paper).

Response times for the sensing types: HP 5 ms, nL 1 ms, SF 50 μs, and FT 250 μs.

The values shown in the Minimum detectable size column were obtained with optimal scanning distance and sensitivity settings.

Outer dimensions (differs according to the model)

Unit: mm

HPF-T039 Core dia. φ0.125

Shape A

HPF-T015 Core dia. φ0.25

Shape B

HPF-T005 Core dia. φ1.0

Shape C

*Area that cannot be bent

HPF-T006 Core dia. φ1.0

Shape D

*Area that cannot be bent

HPF-D039 Core dia. 2 × φ0.25

Shape E

HPF-D019 Core dia. 2 × φ0.25

Shape F

HPF-D006 Core dia. 2 × φ0.5

Shape G

*Area that cannot be bent

HPF-D021 Core dia. 2 × φ0.5

Shape H

HPF-D003 Core dia. 2 × φ1.0

Shape I

*Area that cannot be bent

Screw

Cylindrical

Coaxial

Sleeve

Side View

Narrow View

Flat/Selective Reflection Area

Heat -proof

Chemical -proof

Vacuum -proof

Specialized Use

Lens Unit

Other Accessories

Technical Guide

List of Scanning Distance by Amplifiers Model

Side View

- Light emitted to the side.
- Use to position the switch close to the target object in a limited space.

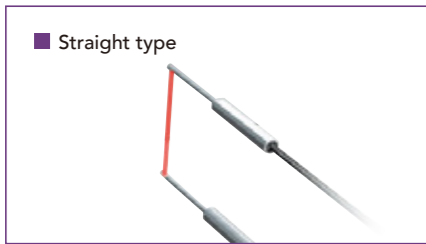

Related pages

Narrow view sensing [P.21](#)

Sleeve-length customization [P.04](#)

Thru scan

Front end dia.	Center of optical axis (from front end)	Shape	Cable		Scanning distance (mm)			Core	Minimum detectable size (mm)	Model No.
			Bend radius	Length	Amp	Mode	Distance			
Extendable ϕ 0.88	0.6	Shape A	5 mm	1 m	HPX-EG00/01	nL	20	ϕ 0.5	ϕ 0.005	HPF-T037
						SF	16			
ϕ 1	1.5	Shape B	1 mm	2 m	HPX-EG00/01	Ft	11	ϕ 0.5	ϕ 0.005	HPF-T026
						HP	41			
ϕ 1	1.5	Shape C	15 mm	2 m	HPX-EG00/01	nL	35	ϕ 0.5	ϕ 0.005	HPF-T007
						SF	20			
ϕ 3	1.5	Shape D	5 mm	2 m	HPX-EG00/01	Ft	15	ϕ 0.5	ϕ 0.005	HPF-T042
						HP	41			

Diffuse scan

Front end dia.	Center of optical axis (from front end)	Shape	Cable		Scanning distance (mm)			Core	Minimum detectable size (mm)	Model No.
			Bend radius	Length	Amp	Mode	Distance			
Extendable ϕ 2	1.5	Shape E	15 mm	2 m	HPX-EG00/01	nL	17	Receiver and emitter ϕ 0.5	ϕ 0.005	HPF-D011
						SF	14			
ϕ 2	1.5	Shape F	15 mm	2 m	HPX-EG00/01	Ft	10	Receiver and emitter ϕ 0.5	ϕ 0.005	HPF-D041
						HP	35			
ϕ 6	1.5	Shape G	20 mm	2 m	HPX-EG00/01	nL	65	Receiver and emitter ϕ 1.0	ϕ 0.005	HPF-D043
						SF	55			

Note:

For scanning distances of the sensing modes, see the Technical Guide (page 47–48).

Scanning distances for diffuse scan were obtained with a standard target object (plain white paper).

Response times for the sensing types: HP 5 ms, nL 1 ms, SF 50 μ s, and FT 250 μ s.

The values shown in the Minimum detectable size column were obtained with optimal scanning distance and sensitivity settings.

Outer dimensions (differs according to the model)

Unit: mm

HPF-T037 Shape A

HPF-T026 Shape B

HPF-T007 Shape C

HPF-T042 Shape D

HPF-D011 Shape E

HPF-D041 Shape F

HPF-D043 Shape G

Unique feature

The fiber unit head of all side-view sensors has a D-shape. This can greatly reduce adjustment man-hours during installation.

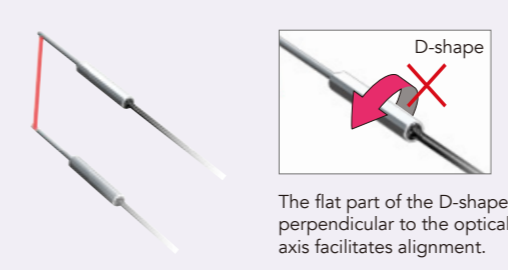

Selection point

The distance from the front end to the center of the optical axis depends on the product structure. Select the model that is suitable for your application.

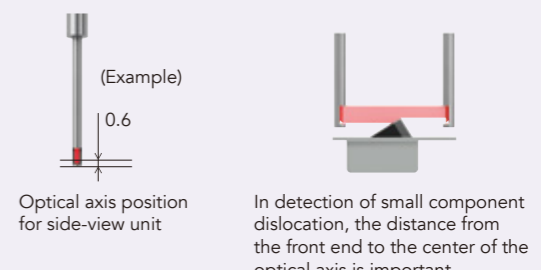

- Screw
- Cylindrical
- Coaxial
- Sleeve
- Side View
- Narrow View
- Flat/Selective Reflection
- Area
- Heat-proof
- Chemical-proof
- Vacuum-proof
- Specialized Use
- Lens Unit
- Other Accessories
- Technical Guide
- List of Scanning Distance by Amplifiers Model

Narrow View

- Light spread minimized.
- Use in a place where light intrusion is undesirable.

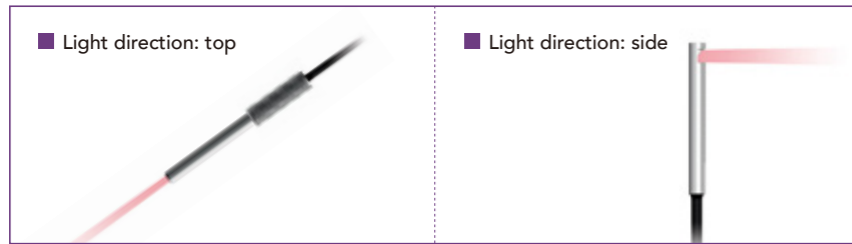

Related pages

If a narrow beam is not required:

Sleeve-type units [P.17](#)

Side-view units [P.19](#)

Outer dimensions (differs according to the model)

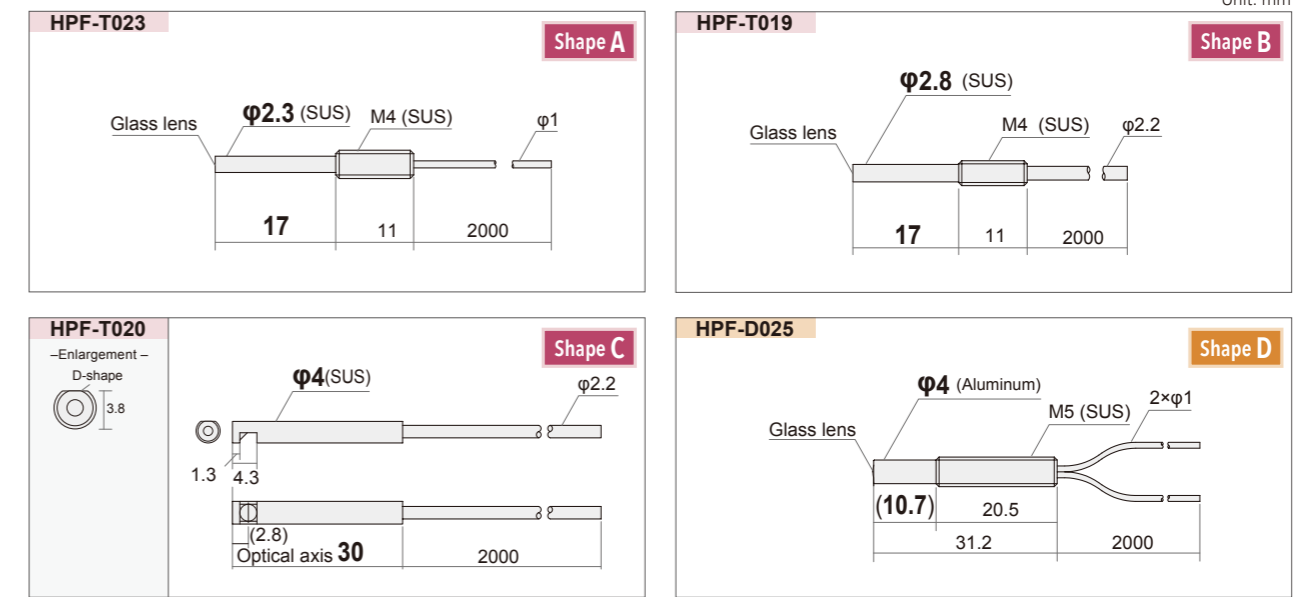

Thru scan

Light emitter	Directional angle (half angle)	Shape	Cable		Scanning distance (mm)			Effective lens diameter	Minimum detectable size (mm)	Model No.
			Bend radius	Length	Amp	Mode	Distance			
Top	1.5°	Shape A	15 mm	2 m	HPX-EG00/01	nL	1200	φ 1.7	φ 0.1	HPF-T023
						SF	1000			
Top	2.5°	Shape B	20 mm	2 m	HPX-EG00/01	Ft	730	φ 2.1	φ 0.1	HPF-T019
						HP	2800			
Side	3°	Shape C	20 mm	2 m	HPX-EG50/51	nL	2400	φ 2.6	φ 0.1	HPF-T020
						SF	1400			
Side	3°	Shape C	20 mm	2 m	HPX-EG00/01	Ft	840	φ 2.6	φ 0.1	HPF-T020
						HP	3200			
Side	3°	Shape C	20 mm	2 m	HPX-EG50/51	nL	2700	φ 2.6	φ 0.1	HPF-T020
						SF	1200			
Side	3°	Shape C	20 mm	2 m	HPX-EG00/01	Ft	1500	φ 2.6	φ 0.1	HPF-T020
						HP	1300			
Side	3°	Shape C	20 mm	2 m	HPX-EG50/51	nL	3500	φ 2.6	φ 0.1	HPF-T020
						SF	920			
Side	3°	Shape C	20 mm	2 m	HPX-EG00/01	Ft	1300	φ 2.6	φ 0.1	HPF-T020
						HP	3000			

Diffuse scan

Light emitter	Directional angle (half angle)	Shape	Cable		Scanning distance (mm)			Effective lens diameter	Minimum detectable size (mm)	Model No.
			Bend radius	Length	Amp	Mode	Distance			
Top	-	Shape D	15 mm	2 m	HPX-EG00/01	nL	20	-	φ 0.005	HPF-D025
						SF	20			
Top	-	Shape D	15 mm	2 m	HPX-EG50/51	Ft	20	-	φ 0.005	HPF-D025
						HP	20			
Top	-	Shape D	15 mm	2 m	HPX-EG00/01	nL	20	-	φ 0.005	HPF-D025
						SF	20			
Top	-	Shape D	15 mm	2 m	HPX-EG50/51	Ft	20	-	φ 0.005	HPF-D025
						HP	20			

Note:

For scanning distances of the sensing modes, see the Technical Guide (page 47–48).

Scanning distances for diffuse scan are obtained with a standard target object (plain white paper).

Response times for the sensing types: HP 5 ms, nL 1 ms, SF 50 μs, and FT 250 μs.

The values shown in the Minimum detectable size column were obtained with optimal scanning distance and sensitivity settings.

NOTEWORTHY

Narrow view types are available also in combination with long-distance lenses and side-view lenses.

(Typical examples)

Optical configuration	Lens unit (model No.)	Fiber unit (model No.)	Directional angle (half angle)
Top	FE-PA-L1	HPF-T003	Approx. 3°
Top	HPF-VL06	HPF-T003	Approx. 3°
Side	FE-PA-S1	HPF-T003	Approx. 10°
Side	HPF-VL05	HPF-T003	Approx. 8°

For lens units, see page 41.

Screw

Cylindrical

Coaxial

Sleeve

Side View

Narrow View

Flat/Selective Reflection

Area

Heat -proof

Chemical -proof

Vacuum -proof

Specialized Use

Lens Unit

Other Accessories

Technical Guide

List of Scanning Distance by Amplifiers Model

21

22

Flat/Vane

- Suitable for installation where space is limited.
- Attach directly to casing.

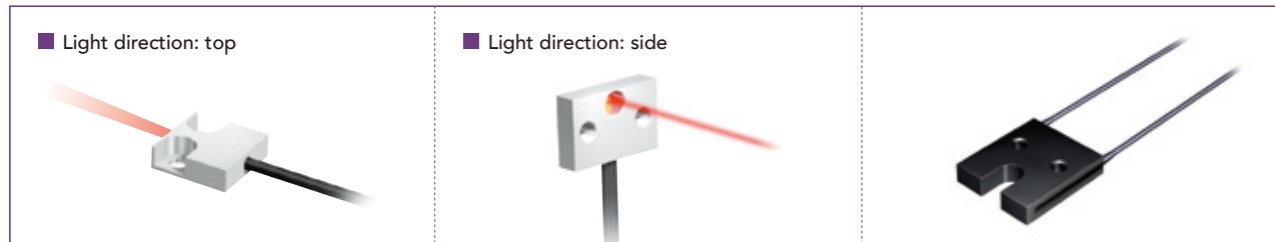

Thru scan

Type	Light emitter	Shape	Cable		Scanning distance (mm)			Core	Minimum detectable size (mm)	Model No.
			Bend radius	Length	Amp	Mode	Distance			
Flat	Top	Shape A	1 mm	2 m	HPX-EG00/01	nL	50	φ0.5	φ0.005	HPF-T028
						SF	42			
Flat	Top	Shape A	1 mm	2 m	HPX-EG50/51	Ft	29	φ0.5	φ0.005	HPF-T028
						HP	110			
Vane type	-	Shape B	15 mm	5 m	HPX-EG00/01	nL	6	φ0.5	φ0.005	HPF-T054-L05
						SF	6			
Vane type	-	Shape B	15 mm	5 m	HPX-EG50/51	Ft	6	φ0.5	φ0.005	HPF-T054-L05
						HP	6			

Diffuse scan

Type	Light emitter	Shape	Cable		Scanning distance (mm)			Core	Minimum detectable size (mm)	Model No.
			Bend radius	Length	Amp	Mode	Distance			
Flat	Flat	Shape C	2 mm	2 m	HPX-EG00/01	nL	37	Receiver and emitter φ1.0	-	HPF-D045LF
						SF	31			
Flat	Flat	Shape C	2 mm	2 m	HPX-EG50/51	Ft	21	Receiver and emitter φ1.0	-	HPF-D045LF
						HP	80			
Flat	Flat	Shape C	2 mm	2 m	HPX-EG50/51	nL	70	Receiver and emitter φ1.0	-	HPF-D045LF
						Ft	30			

Note:
 For scanning distances of the sensing modes, see the Technical Guide (page 47–48).
 Scanning distances for diffuse scan are obtained with a standard target object (plain white paper).
 Response times for the sensing types: HP 5 ms, nL 1 ms, SF 50 μs, and FT 250 μs.
 The values shown in the Minimum detectable size column were obtained with optimal scanning distance and sensitivity settings.

Outer dimensions (differs according to the model)

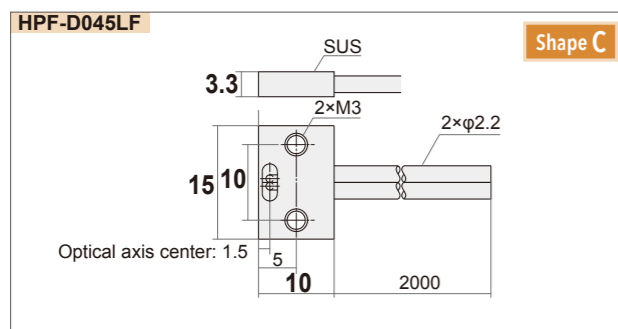
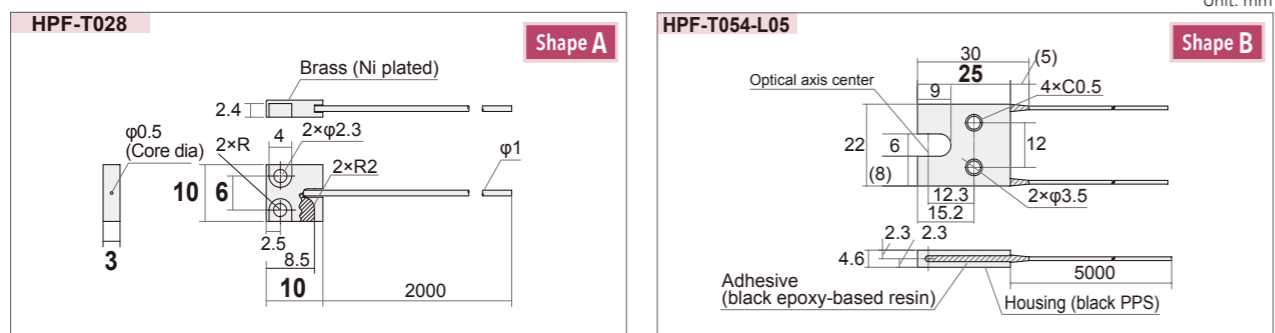

Limited Reflective

- Resistant to interference from the background.
- Use for target object detection in a limited area.

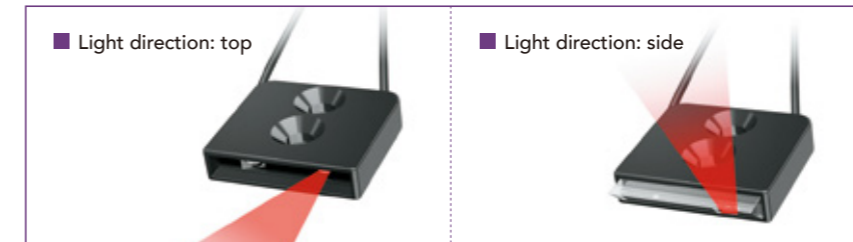

Diffuse scan

Light emitter	Shape	Cable		Scanning distance (mm)			Minimum detectable size (mm)	Model No.
		Bend radius	Length	Amp	Mode	Distance		
Top	Shape A	15 mm	2 m	HPX-EG00/01	nL	7.4±1.2	φ0.005	HPF-D028T
					SF	7.4±1.6		
Top	Shape A	15 mm	2 m	HPX-EG50/51	Ft	7.4±1.6	φ0.005	HPF-D028T
					HP	7.4±1.6		
Flat	Shape B	15 mm	2 m	HPX-EG00/01	nL	2.5±0.5	φ0.005	HPF-D028
					SF	2.5±0.5		
Flat	Shape B	15 mm	2 m	HPX-EG50/51	Ft	2.5±0.5	φ0.005	HPF-D028
					HP	2.5±0.5		
Flat	Shape C	15 mm	2 m	HPX-EG00/01	nL	5.2±1.0	φ0.005	HPF-D028F
					SF	5.2±1.0		
Flat	Shape C	15 mm	2 m	HPX-EG50/51	Ft	5.2±1.6	φ0.005	HPF-D028F
					HP	5.2±1.6		

Note:
 For scanning distances of the sensing modes, see the Technical Guide (page 48).
 Scanning distances for diffuse scan are obtained with a standard target object (plain white paper).
 Response times for the sensing types: HP 5 ms, nL 1 ms, SF 50 μs, and FT 250 μs.
 The values shown in the Minimum detectable size column were obtained with optimal scanning distance and sensitivity settings.

Outer dimensions (differs according to the model)

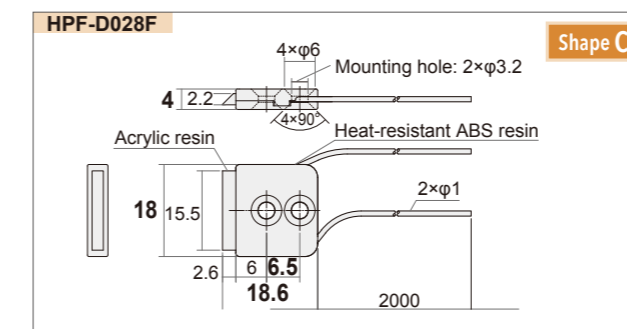
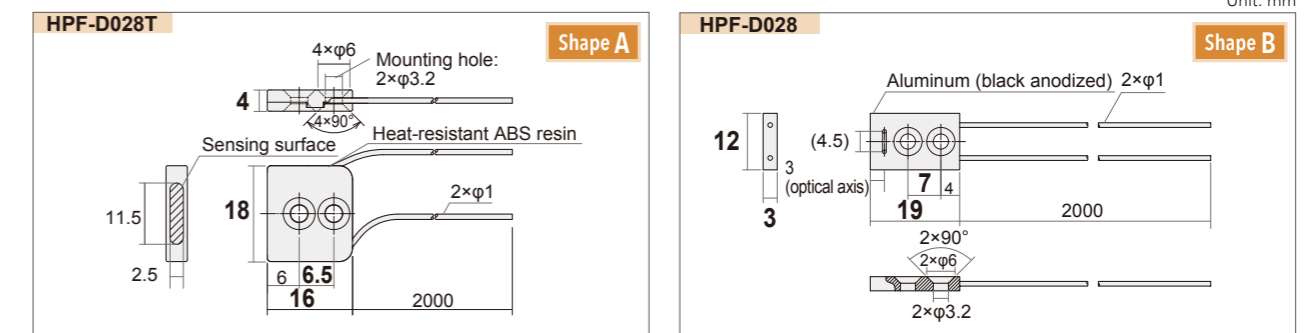

Screw
Cylindrical
Coaxial
Sleeve
Side View
Narrow View
Flat/Selective Reflection
Area
Heat-proof
Chemical-proof
Vacuum-proof
Specialized Use
Lens Unit
Other Accessories
Technical Guide
List of Scanning Distance by Amplifiers Model

Area

- Wide light beam.
- Use for target object with varying detection positions, detection of meandering, etc.

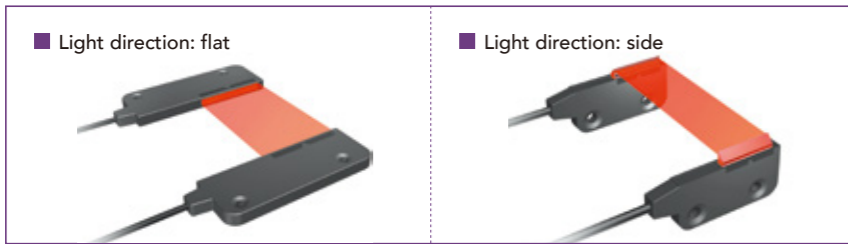

Thru scan

Type	Optical configuration	Area width (mm)	Shape	Cable		Scanning distance (mm)			Minimum detectable size (mm)	Model No.
				Bend radius	Length	Amp	Mode	Distance		
Array	Flat	5.25	Shape A	4 mm	2 m	HPX-EG00/01	nL	270	φ0.2	HPF-T021
							SF	220		
Array	Flat	15	Shape B	15 mm	2 m	HPX-EG00/01	nL	1200	φ0.2	HPF-T021T
							SF	1000		
Screen	Flat	30	Shape D	15 mm	2 m	HPX-EG00/01	nL	2000	φ0.4	HPF-T021WT
							SF	1600		
Screen	Side	15	Shape C	15 mm	2 m	HPX-EG00/01	nL	1100	φ0.2	HPF-T021S
							SF	960		
							HP	670		
							HP	2700		
							nL	2300		
							Ft	1000		

Diffuse scan

Type	Optical configuration	Area width (mm)	Shape	Cable		Scanning distance (mm)			Minimum detectable size (mm)	Model No.
				Bend radius	Length	Amp	Mode	Distance		
Array	Flat	10.85	Shape E	4 mm	2 m	HPX-EG00/01	nL	100	φ0.005	HPF-D026
							SF	90		
							HP	60		
							HP	230		
							nL	200		
							Ft	85		

Note:
 For scanning distances of the sensing modes, see the Technical Guide (page 47–48).
 Scanning distances for diffuse scan are obtained with a standard target object (plain white paper).
 Response times for the sensing types: HP 5 ms, nL 1 ms, SF 50 μs, and FT 250 μs.
 The values shown in the Minimum detectable size column were obtained with optimal scanning distance and sensitivity settings.

NOTEWORTHY

Type	Array type	Screen type
Features	Small diameter fibers are aligned in a row. Smaller and slimmer sensor heads are also available.	Light is collimated by the lens. This increases the scanning range and makes the light uniform.

Outer dimensions (differs according to the model)

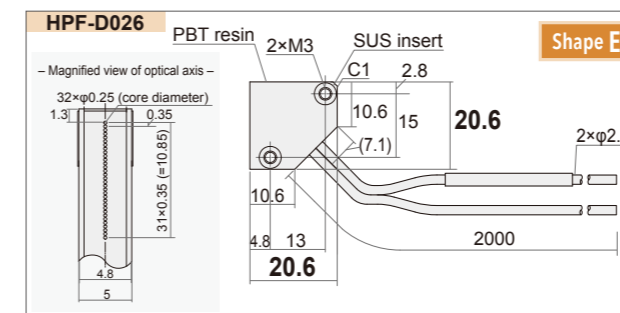
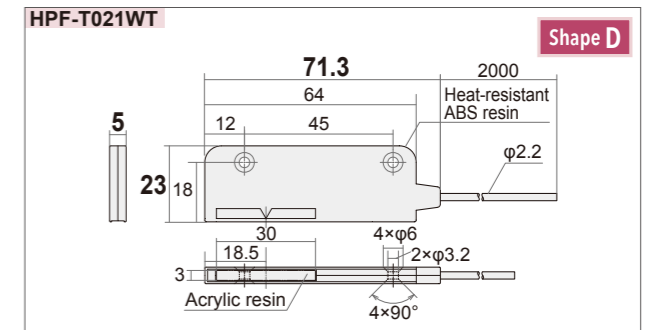
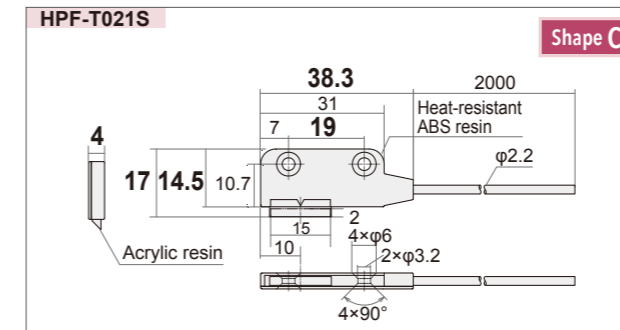
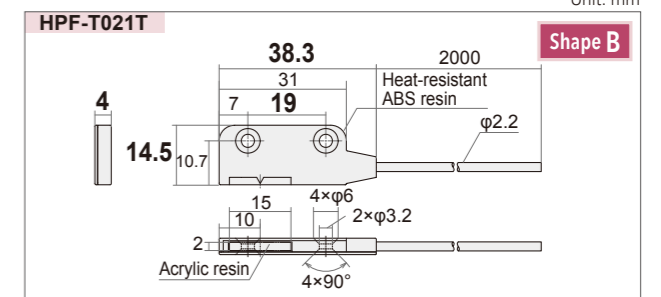
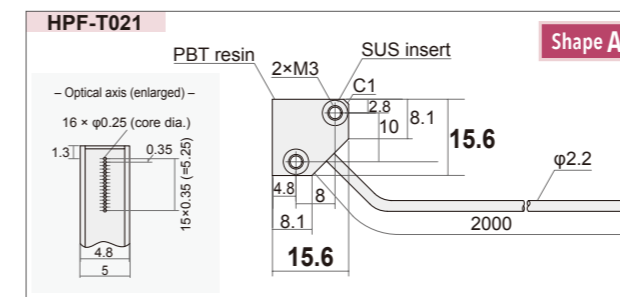

Accessory

Model HPF-T021T

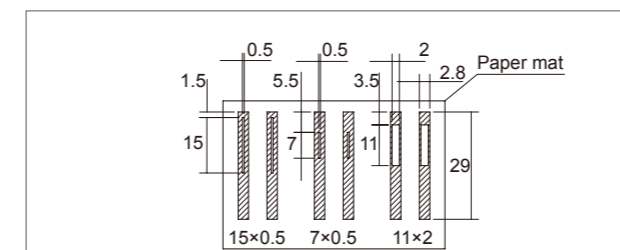

Material: Transparent polyester film (black print on back)
 Model HPF-T021T comes with slits. Use the appropriate slit with the unit to achieve the desired scanning distance and resolution. The slits can be bought as parts. Model No: HPX-PA07

Model HPF-T021WT

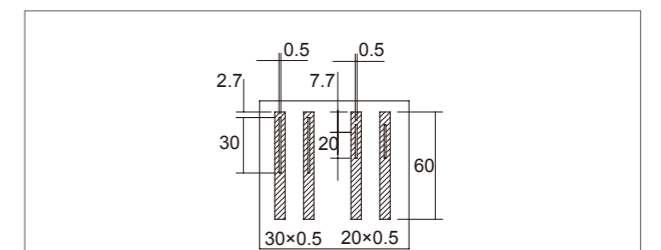

Material: Transparent polyester film (black print on back)
 Model HPF-T021WT comes with slits. Use the appropriate slit with the unit to achieve the desired scanning distance and resolution.

Screw
Cylindrical
Coaxial
Sleeve
Side View
Narrow View
Flat/Selective Reflection
Area
Heat-proof
Chemical-proof
Vacuum-proof
Specialized Use
Lens Unit
Other Accessories

Technical Guide
List of Scanning Distance by Amplifiers Model

Heat-proof

- Resistant to high temperatures.
- Use in environments up to 350 °C.

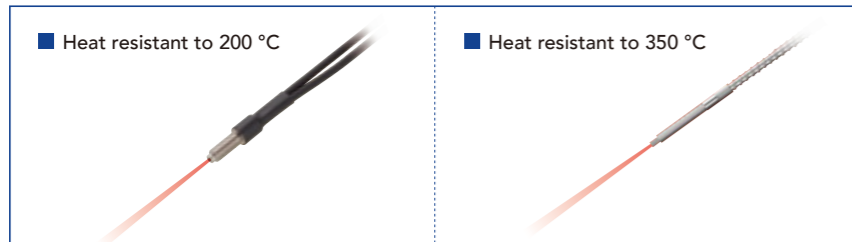

Related pages
Compatible lenses
P.45

Thru scan

Heatproof	Type	Shape	Cable		Scanning distance (mm)			Element	Minimum detectable size (mm)	Model No.
			Bend radius	Length	Amp	Mode	Distance			
105 °C	Straight	Lens attachable -30 to +105 °C Shape A	25 mm	2 m	HPX-EG00/01	nL	240	φ 1.0	φ 0.005	HPF-T012 ^{*1}
					HPX-EG50/51	nL	140			
150 °C	Straight	-60 to +150 °C Shape B	35 mm	2 m	HPX-EG00/01	nL	410	φ 1.5	φ 0.01	HPF-T017 ^{*1}
					HPX-EG50/51	nL	350			
200 °C	Straight	Lens attachable -30 to +200 °C Shape C	15 mm	1 m	HPX-EG00/01	nL	210	φ 1.0	φ 0.005	HPF-T018
					HPX-EG50/51	nL	180			
350 °C	Straight	Lens attachable -30 to +350 °C Shape D	15 mm	2 m	HPX-EG00/01	nL	120	φ 1.0	φ 0.005	HPF-T014
					HPX-EG50/51	nL	480			

Diffuse scan

Heatproof	Type	Shape	Cable		Scanning distance (mm)			Element	Minimum detectable size (mm)	Model No.
			Bend radius	Length	Amp	Mode	Distance			
105 °C	Straight	-30 to +105 °C Shape E	25 mm	2 m	HPX-EG00/01	nL	100	Receiver and emitter φ 1.0	φ 0.005	HPF-D013 ^{*1}
					HPX-EG50/51	nL	80			
150 °C	Straight	-60 to +150 °C Shape F	35 mm	2 m	HPX-EG00/01	nL	55	Receiver and emitter φ 1.5	φ 0.005	HPF-D022 ^{*1}
					HPX-EG50/51	nL	190			
350 °C	Straight	-30 to +350 °C Shape G	25 mm	2 m	HPX-EG00/01	nL	190	φ 1.5	φ 0.005	HPF-D015
					HPX-EG50/51	nL	85			

Note:

For scanning distances of the sensing modes, see the Technical Guide (page 47–48).

Scanning distances for diffuse scan are obtained with a standard target object (plain white paper).

Response times for the sensing types: HP 5 ms, nL 1 ms, SF 50 μs, and FT 250 μs.

The values shown in the Minimum detectable size column were obtained with optimal scanning distance and sensitivity settings.

*1. If a fiber unit is continuously used in an environment where it is at the upper limit of the operating temperature range, the detection distance will decrease. When selecting a fiber unit, be sure to take the ambient temperature into account so that the sensor is not continuously operating near its limits.

Outer dimensions (differs according to the model)

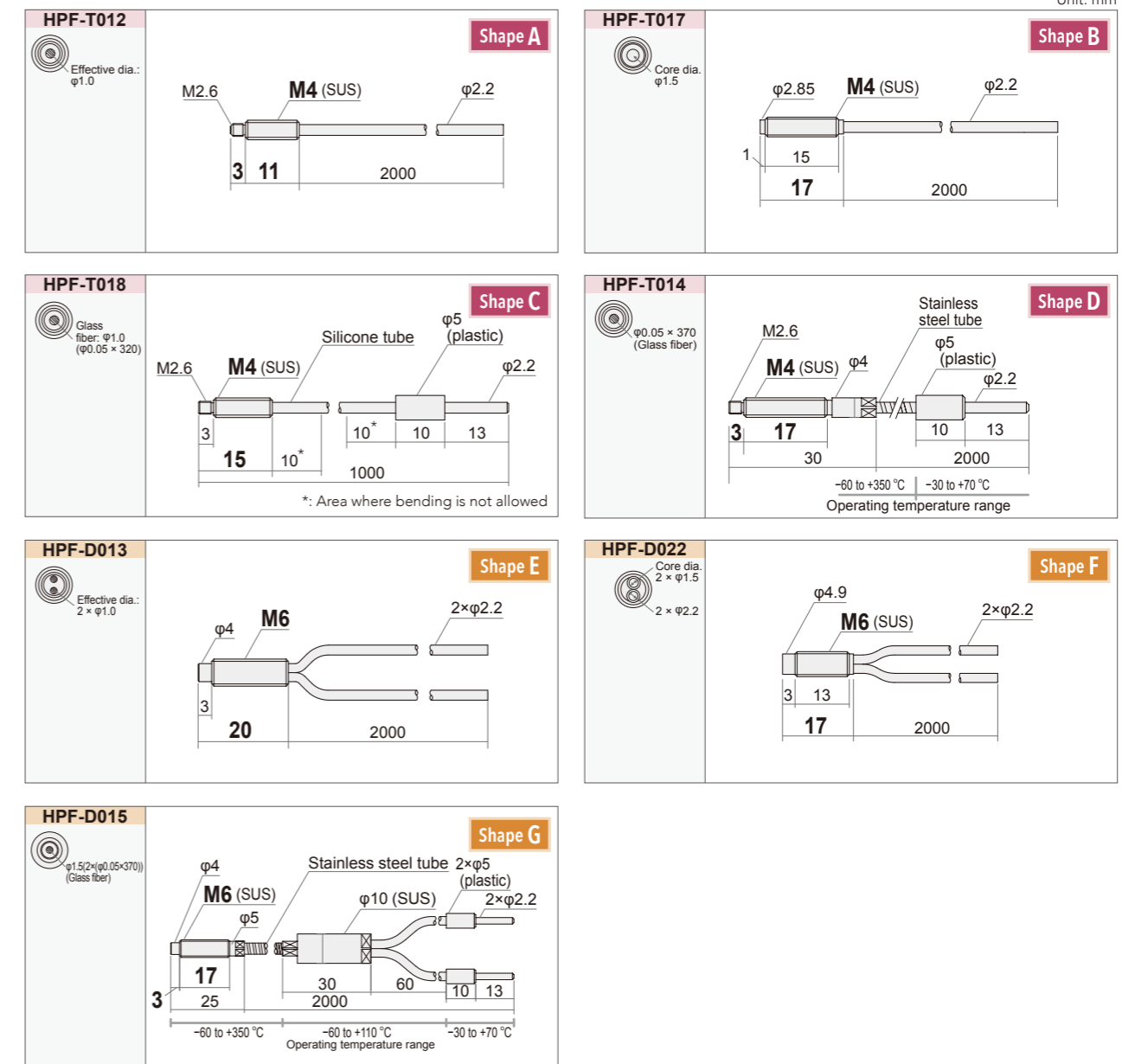

NOTEWORTHY

Use the lens unit appropriate for your application.
Select a lens with the desired heat resistance.*

Heatproof temp.	Lens (Model No.)	Type	Sensitivity
200 °C	FE-PA-L1	Long distance	Approx. ×6
	FE-PA-S1	Side view	-
350 °C	HPF-VL06	Long distance	Approx. ×10
	HPF-VL05	Side view	-

*Compatible lens units: p.41, 45

Screw

Cylindrical

Coaxial

Sleeve

Side View

Narrow View

Flat/Selective Reflection

Area

Heat-proof

Chemical-proof

Vacuum-proof

Specialized Use

Lens Unit

Other Accessories

Technical Guide

List of Scanning Distance by Amplifiers Model

Technical Guide

List of Scanning Distance by Amplifiers Model

Technical Guide

Technical Guide

Chemical-proof

- Protected with PFA tubing for excellent chemical resistance.

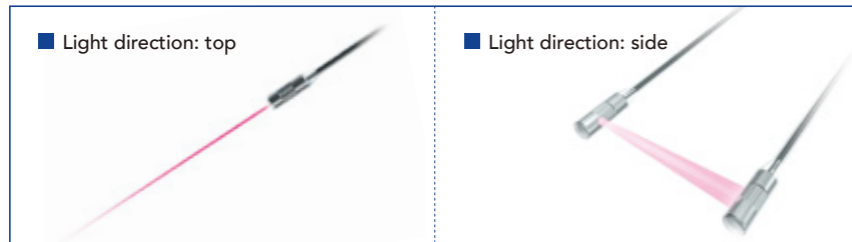

Related pages

Wet process sensors for level & leak detection

P.33 P.35 P.37

Usage notes P.44

Outer dimensions (differs according to the model)

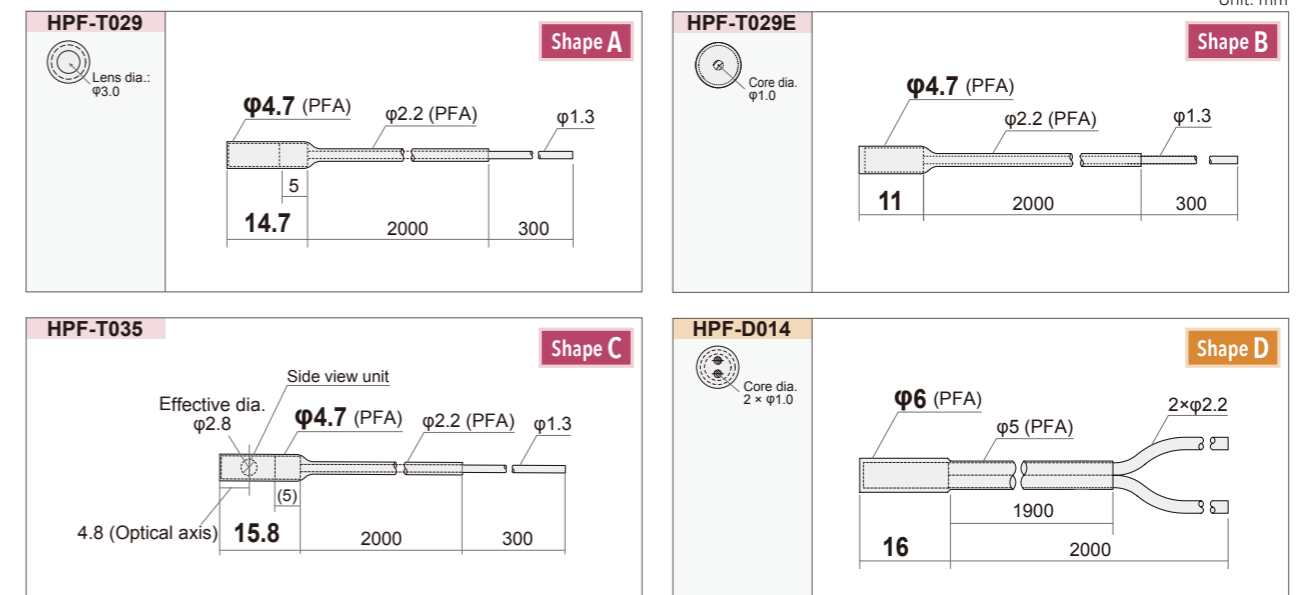

Thru scan

Light emitter	Size	Shape	Cable		Scanning distance (mm)			Minimum detectable size (mm)	Model No.
			Bend radius	Length	Amp	Mode	Distance		
Top	φ4.7	Shape A	20 mm	2 m	HPX-EG00/01	nL	1500	φ0.1	HPF-T029
						SF	1200		
Top	φ4.7	Shape B	20 mm	2 m	HPX-EG00/01	HP	880	φ0.1	HPF-T029E
						nL	3500		
Top	φ4.7	Shape C	20 mm	2 m	HPX-EG00/01	HP	1300	φ0.1	HPF-T035
						nL	3000		
Side	φ4.7	Shape C	20 mm	2 m	HPX-EG00/01	nL	280	φ0.1	HPF-T029E
						SF	230		
Side	φ4.7	Shape C	20 mm	2 m	HPX-EG00/01	HP	160	φ0.1	HPF-T035
						nL	640		
Side	φ4.7	Shape C	20 mm	2 m	HPX-EG50/51	nL	550	φ0.1	HPF-T029E
						SF	240		
Side	φ4.7	Shape C	20 mm	2 m	HPX-EG50/51	nL	350	φ0.1	HPF-T035
						SF	300		
Side	φ4.7	Shape C	20 mm	2 m	HPX-EG50/51	HP	210	φ0.1	HPF-T035
						nL	810		
Side	φ4.7	Shape C	20 mm	2 m	HPX-EG50/51	nL	690	φ0.1	HPF-T035
						SF	300		

Diffuse scan

Light emitter	Size	Shape	Cable		Scanning distance (mm)			Minimum detectable size (mm)	Model No.
			Bend radius	Length	Amp	Mode	Distance		
Top	φ6	Shape D	PFA area: 80 mm Cable area: 20 mm	2 m	HPX-EG00/01	nL	50	-	HPF-D014
						SF	50		
Top	φ6	Shape D	PFA area: 80 mm Cable area: 20 mm	2 m	HPX-EG50/51	HP	50	-	HPF-D014
						nL	50		
Top	φ6	Shape D	PFA area: 80 mm Cable area: 20 mm	2 m	HPX-EG50/51	SF	50	-	HPF-D014
						FT	50		

Note:

For scanning distances of the sensing modes, see the Technical Guide (page 47-48).

Scanning distances for diffuse scan are obtained with a standard target object (plain white paper).

Response times for the sensing types: HP 5 ms, nL 1 ms, SF 50 μs, and FT 250 μs.

For chemical resistance of fluorine-resin, see the Technical Guide (page 45).

The values shown in the Minimum detectable size column were obtained with optimal scanning distance and sensitivity settings.

NOTEWORTHY

Installation man-hours greatly reduced

Simply cut the PFA-jacketed cable to length and insert as is into the amplifier.

Simply cut the PFA-jacketed cable.

Insert as is into the amplifier. The insertion area requires no PFA working.

Conventionally

PFA tube must be stripped off before inserting fiber.

After improvement

Fiber cut with a cutter can be directly connected to an amplifier.

This is the difference!

Saves space



Tube has small outside diameter of 2.2 mm, which can save considerable space compared with previous models. Bend radius is also greatly improved.

- Screw
- Cylindrical
- Coaxial
- Sleeve
- Side View
- Narrow View
- Flat/Selective Reflection Area
- Heat -proof
- Chemical -proof
- Vacuum -proof
- Specialized Use
- Lens Unit
- Other Accessories

Vacuum-proof

- Usable in a vacuum.
- Cable length can be specified.

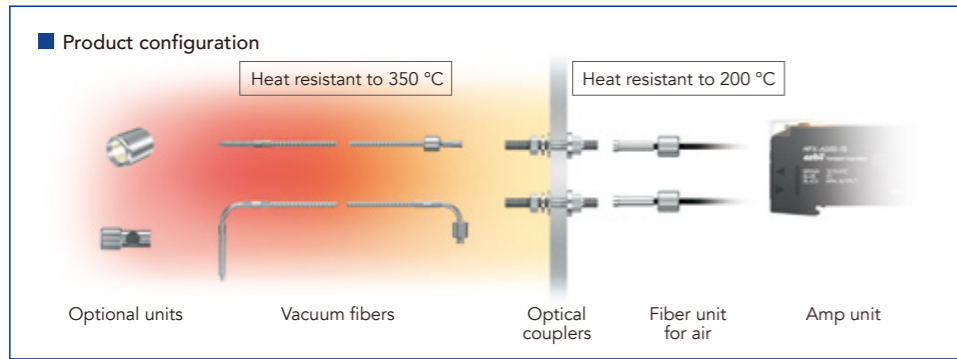

Related pages
Usage notes
[P.46](#)

Configuration of vacuum fiber model numbers

HPF	-VT	0	S	-S1000	(Typical examples)
Base model No.	Model	Head shape	Coupler side shape	Cable length	Description
HPF	-VT				Thru scan
	-VD				Diffuse scan
		0			Straight
		1			Elbow (VT type only)
			S		Straight
			E		Elbow
				Cable length	Ordering increment
				-S_____	25 mm to 500 mm 25 mm
				-S_____	550 mm to 1500 mm 50 mm
				-S_____	1600 mm to 5000 mm 100 mm

Cable drawing

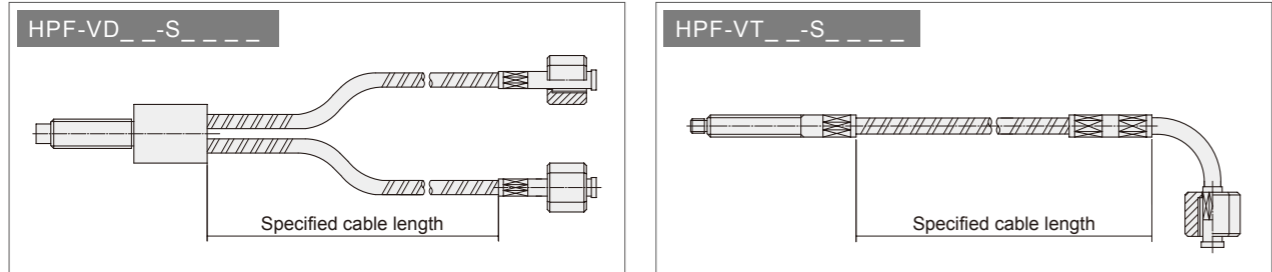

CHART

Scanning distance characteristics

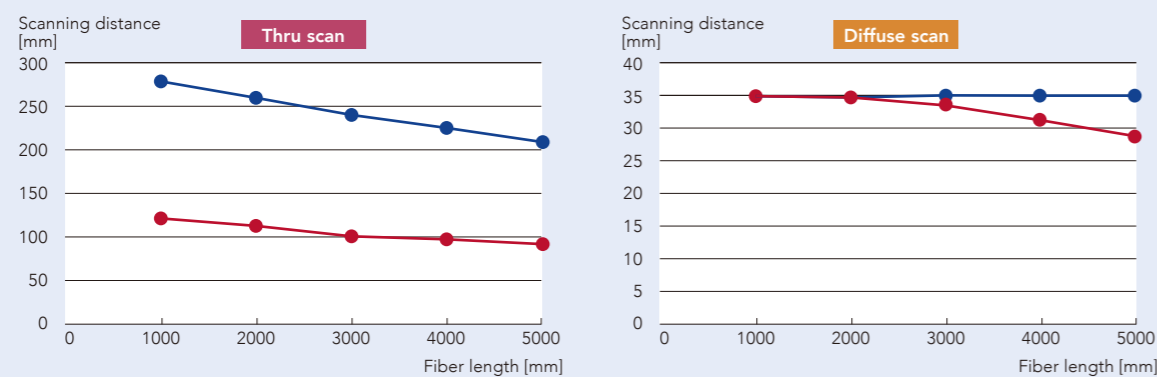

*For fiber units for air, HPF-VA01 is used for calculation.

*Scanning distances for diffuse-scan were obtained using a standard target object (plain white paper).

Options for vacuum fiber unit

Product name	Shape	Heatproof	Other specifications	Model No.
Optical coupler (two units)		200 °C	-	HPF-VJ03
Fiber unit for air (two units in a pair)		70 °C	Cable length: 2 m Bend radius: 20 mm Cuttable	HPF-VA01
Long-distance lens unit (two units)		350 °C	Scanning distance: ×10	HPF-VL06
Side-view unit (two units)		350 °C	-	HPF-VL05

Outer dimensions (differs according to the model)

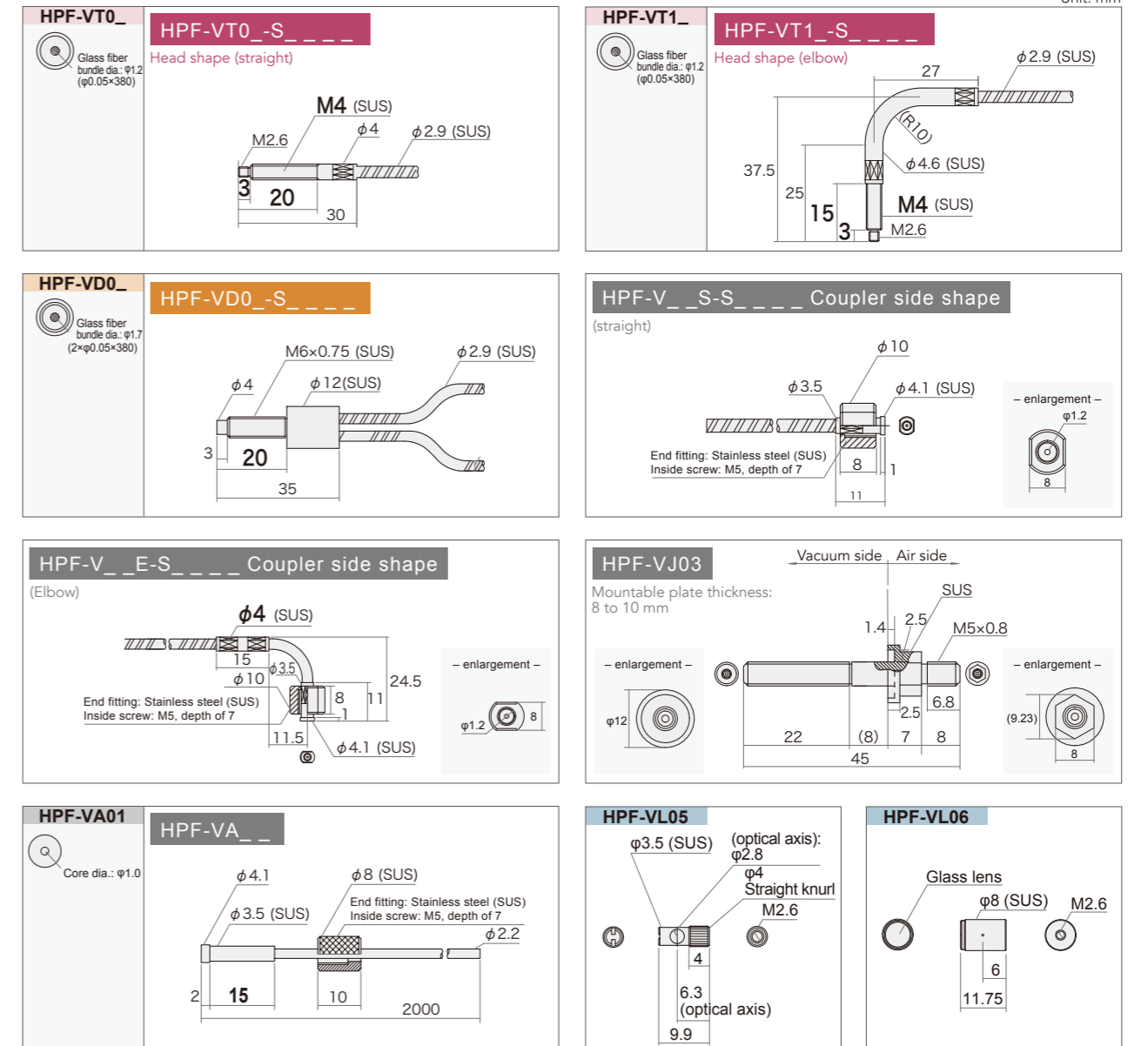

Screw
Cylindrical
Coaxial
Sleeve
Side View
Narrow View
Flat/Selective Reflection
Area
Heat-proof
Chemical-proof
Vacuum-proof
Specialized Use
Lens Unit
Other Accessories

Technical Guide
List of Scanning Distance by Amplifiers Model

Specialized Use < Contact-Type Liquid Level Fiber Units >

- All-resin structure ensures no metal contamination.

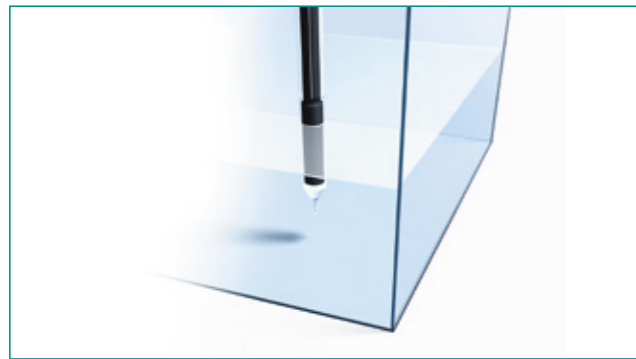

Problems due to liquid accumulation are reduced by Azbil Corporation's innovative front end structure.

Product lineup includes a small-diameter model ($\phi 4$) for easier cable routing.

Principle of detection

Reliable detection is achieved by the proprietary structure of the fiber tip

The proprietary structure provided at the tip of the fiber reduces malfunction due to liquid clinging. The lens built into the tip of the fiber ensures a large difference in light quantity between the conditions when liquid is present and absent.

Tip and internal structure

The molded prism fiber tip readily sheds water drops.

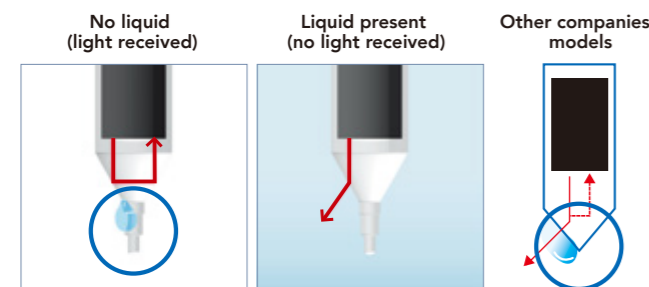
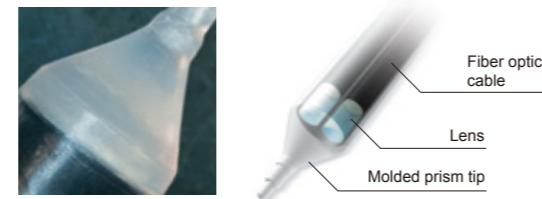

The principle uses the difference in the reflective index due to the presence of liquid.

Recommended compatible amplifier unit

Model HPX-EG00/01

<Exterior view>



<Operation panel>



<Typical models>

Model No.	Output
HPX-EG00-1S	NPN
HPX-EG00-2S	PNP

Auto sensitivity switch function

This function automatically optimizes the sensitivity setting during auto tuning, affording easy operation while delivering the highest detection performance.

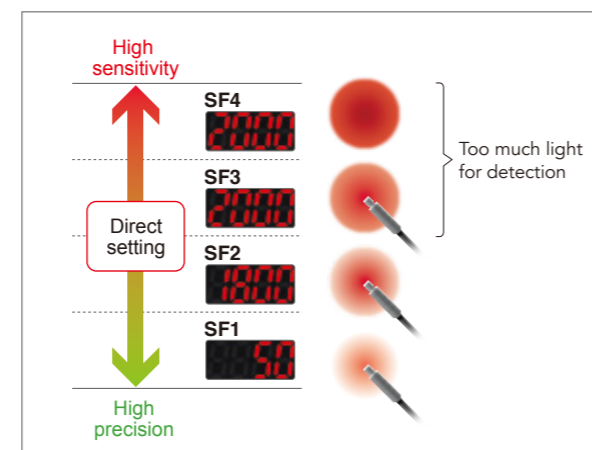

Diffuse scan

Type	Shape	Cable		Model No.
		Bend radius	Length	
$\phi 4$	-30 to $+105$ °C	PFA area: 30 mm Cable area: 15 mm	2 m Cutttable	HPF-D033
$\phi 6$	-30 to $+105$ °C	PFA area: 40 mm Cable area: 25 mm	2 m Cutttable	HPF-D027

Outer dimensions (differs according to the model)

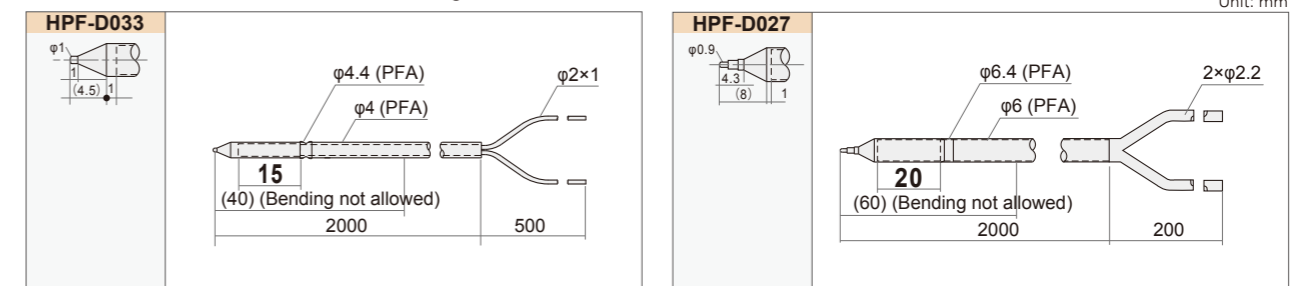

Usage Notes

Contact-type liquid level detection

When installing the unit, use a commercially available fluorine-resin joint that matches the outside diameter of the PFA tube.

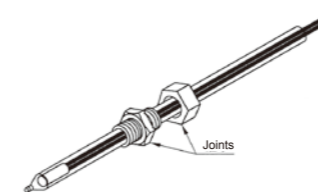

- Some liquid properties, such as milky white color, may make the liquid undetectable.
- Be careful not to bump the fiber unit tip (especially the conical part). Operation may be unstable due to scratches on or deformation of the sensing head.
- If chattering occurs due to liquid dripping or bubbles, use a timer.

- Operation may be unstable under the following conditions:

- Air bubbles adhering to the conical part of the sensing head
- Chemical precipitate on the conical part of the sensing head
- Liquids of high viscosity

Chemical resistance of PFA

See the Technical Guide (page 45).

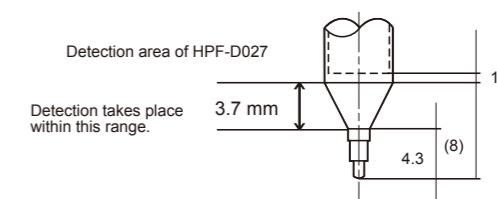

Liquid level detection positions vary depending on the surface tension of the liquid and the wet condition of the fiber unit's detection area.

Screw

Cylindrical

Coaxial

Sleeve

Side View

Narrow View

Flat/Selective Reflection Area

Area

Heat -proof

Chemical -proof

Vacuum -proof

Specialized Use

Lens Unit

Other Accessories

Technical Guide

List of Scanning Distance by Amplifiers Model

Specialized Use < Pipe-Mounted Liquid Level Fiber Units >

- A 16-axis array of light beams greatly eliminates interference from water droplets and air bubbles.



Product lineup includes differing detection methods for fail-safe detection.

Can be used for pipe diameters of 3 to 19 mm.

Thru scan (Attached to pipe)

Type	Compatible pipe dia.	Shape	Cable			Model No.
			Bend radius	Length	Coating material	
Liquid-absent received light	φ 8 to φ 19 mm (3/4B)		4 mm	5 m Cuttable	PFA	HPF-T034
				2 m Cuttable	Polyethylene	HPF-T034E HPF-T034E-L02
Liquid-present received light	φ 3 to φ 13 mm		4 mm	5 m Cuttable	PFA	HPF-T032
				2 m Cuttable	Polyethylene	HPF-T032E HPF-T032E-L02

Use with PFA transparent pipe with wall thickness of 1 mm.

Depending on the pipe actually used, as well as the liquid thru scan and refractive ratios, fiber unit detection may not be reliable, so be sure to test the operation before use.

If the fiber unit is used with other than the recommended pipe, material, or wall thickness, please test before use or consult our sales staff.

Principle of detection

Operating principle of models HPF-T034 and T034E

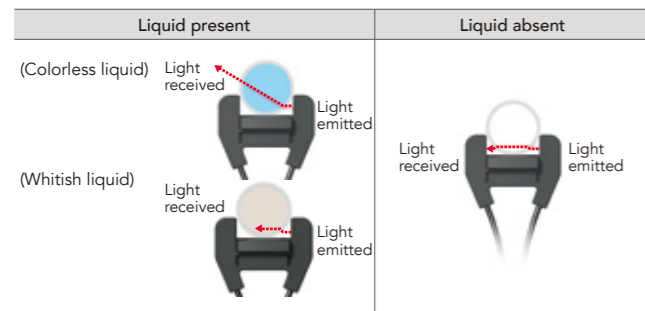

Light reception is blocked when liquid is present, which prevents false detection due to a change in the liquid's color.

Operating principle of models HPF-T032 and T032E

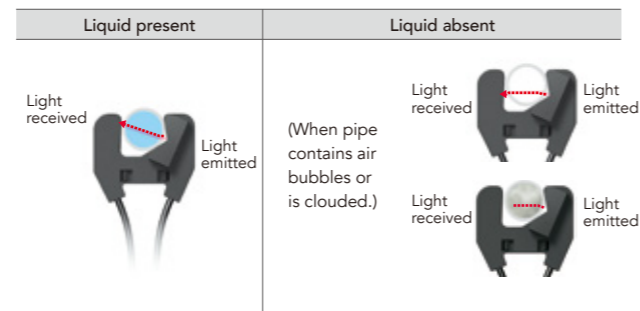

Clouding and bubbles reduce the level of received light, but thanks to the operating principle (light = liquid present) they do not increase the risk of false detection.

Outer dimensions (differs according to the model)

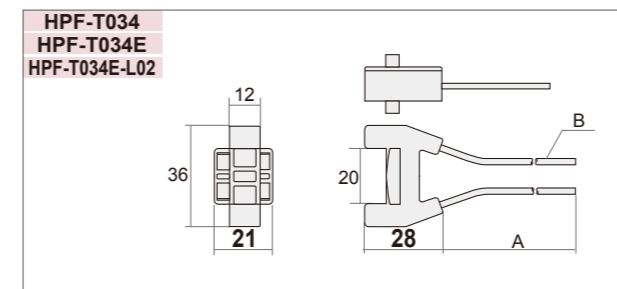

Model No.	Cable length (A)	Cable dia. (B)
HPF-T034	5000 mm min.	2×φ2.3
HPF-T034E	5000 mm min.	2×φ2.2
HPF-T034E-L02	2000 mm min.	2×φ2.2

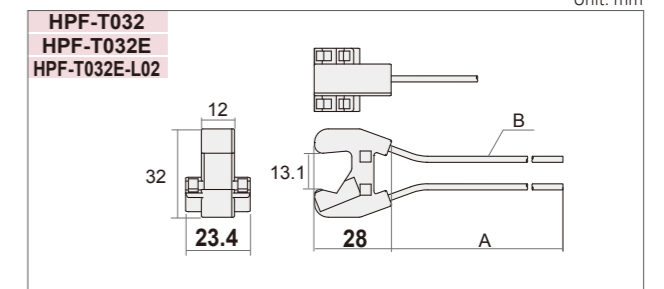

Model No.	Cable length (A)	Cable dia. (B)
HPF-T032	5000 mm min.	2×φ2.3
HPF-T032E	5000 mm min.	2×φ2.2
HPF-T032E-L02	2000 mm min.	2×φ2.2

Product features

Array of 16 optical axes eliminates the effects of air bubbles and water droplets



Adverse effects from air bubbles and water droplets are reduced, resulting in reliable detection.

PFA-jacketed optical fiber



Fiber-optic cables protected by chemical-resistant resin can be run through machines and equipment safely (Model HPF-T032 and HPF-T034 only).

Fail-safe concept

Upper limit detection

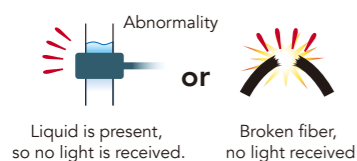

Required optical system
Models that receive light when there is no liquid
**Model HPF-T034/
HPF-T034E**

Lower limit detection

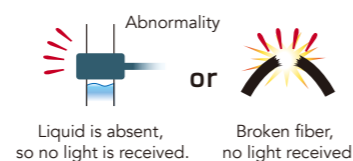

Required optical system
Models that receive light when liquid is present
**Model HPF-T032/
HPF-T032E**

Usage Notes

■ Pipe-mounted liquid level detection

Attach the unit using the supplied cable ties and non-slip tubes as shown here. Securely fasten both the upper and lower cable ties and cut off any excess. Where additional cable ties are required, use ones which are no more than 2.5 mm wide (dimension A in the figure).

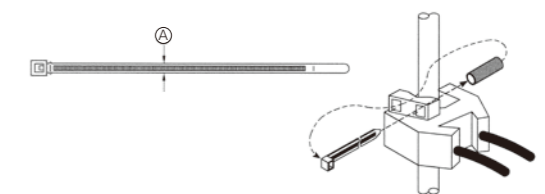

* The supplied cable ties (with non-slip tubing) can also be purchased separately.
Model: SZ-A01 (5 sets)

Specialized Use < Liquid Leakage Fiber Units >

- PFA jacket affords outstanding ease of routing.



Space-saving switch head height of only 9.9 mm

Can be used in explosion-proof atmospheres because the cable is optical fiber.

(Be sure to check the explosion-proof stipulations for your equipment or device before use.)

Principle of detection

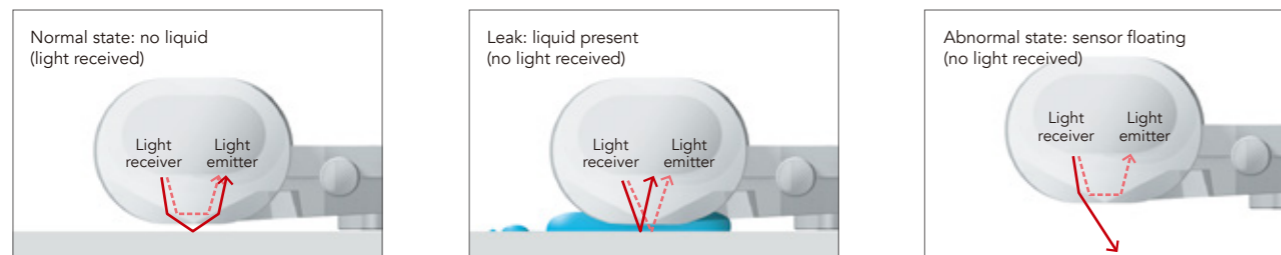

When there is a leak, no light reaches the receiver. This is the same result as when the fiber cable breaks or is disconnected, ensuring fail-safe operation. (When using the unit in a pan, remember to secure it with a stud.)

Diffuse scan

Shape (mm)	Cable		Model No.
	Bend radius	Length	
-30 to +70 °C	20 mm	5 m	HPF-D040
		Cuttable	

Outer dimensions (differs according to the model)

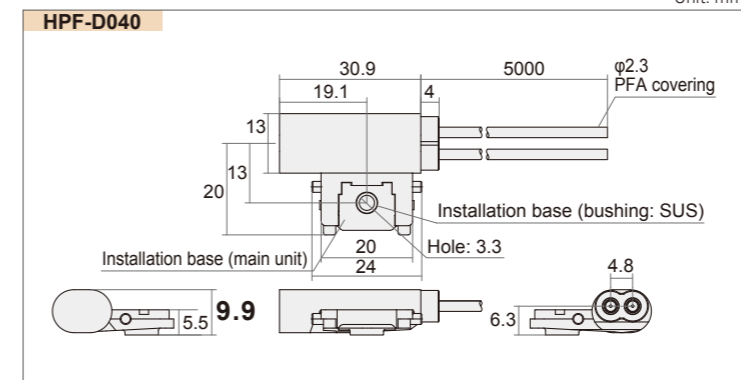

Usage Notes

Liquid leakage detection

When using an SUS mounting base, insert the welded M3 stud bolt into the base's mounting hole and fasten it with an M3 nut (not supplied). Then put the ridges of the mounting base into the grooves of the fiber unit, and slide the base forward until it is in place.

Use in explosive atmospheres

Generally, the fiber unit is structured only to transmit light and so cannot cause electrical explosions or ignite fires. Therefore, the fiber and amplifier units can be used with the fiber unit placed in a dangerous place, and the amplifier unit in a non-dangerous place. Nevertheless, check the explosion-proof regulations required for the equipment used before using the sensor.

Chemical resistance of PFA

See the Technical Guide (page 45).

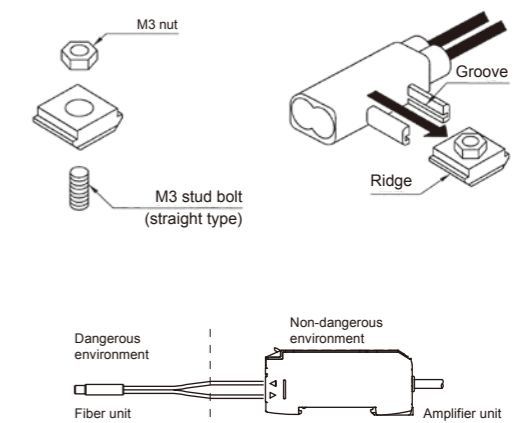

Screw

Cylindrical

Coaxial

Sleeve

Side View

Narrow View

Flat/Selective Reflection

Area

Heat -proof

Chemical -proof

Vacuum -proof

Specialized Use

Lens Unit

Other Accessories

Technical Guide

List of Scanning Distance by Amplifiers Model

Lens Units < Micro-Spot Lens >

- Lens units that produce a micro-spot by combination with a coaxial fiber unit.
- Lenses can be selected according to the target object size.

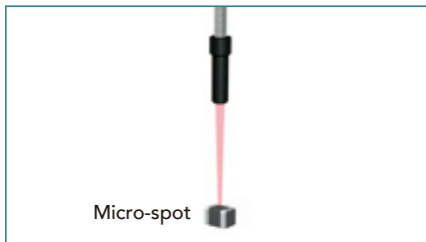

Related pages
Compatible fiber units
P.15 (Coaxial)

For diffuse scan type

Type	Shape	Minimum spot dia.	Focus distance	Combined fiber		Model No.
				Model No.	Spot dia.	
Micro-spot	-30 to +70 °C Shape A	Approx. 0.1 mm • Spot dia. image	4.6 mm ± 0.2 mm	HPF-D034	Approx. 0.1 mm	HPF-LU07
				HPF-D010	Approx. 0.2 mm	
				HPF-D032	Approx. 0.2 mm	
	-30 to +70 °C Shape A	Approx. 0.2 mm • Spot dia. image	7.0 mm ± 0.5 mm	HPF-D034	Approx. 0.2 mm	HPF-LU01
				HPF-D010	Approx. 0.4 mm	
				HPF-D032	Approx. 0.4 mm	
	-30 to +70 °C Shape B	Approx. 1.0 mm • Spot dia. image	19 mm ± 1.0 mm	HPF-D034	Approx. 0.4 mm	HPF-LU02
				HPF-D010	Approx. 1.0 mm	
				HPF-D032	Approx. 2.0 mm	
	-30 to +70 °C Shape C	Approx. 1.0 mm • Spot dia. image	33 mm ± 2.0 mm	HPF-D034	Approx. 2.0 mm	HPF-LU08
				HPF-D010	Approx. 2.0 mm	
				HPF-D032	Approx. 2.0 mm	

Outer dimensions (differs according to the model)

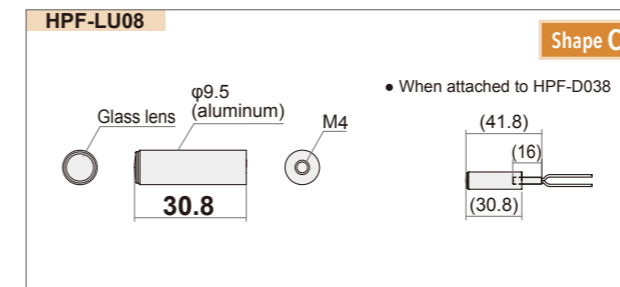
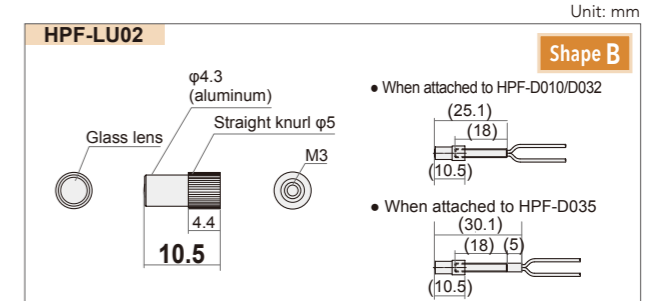
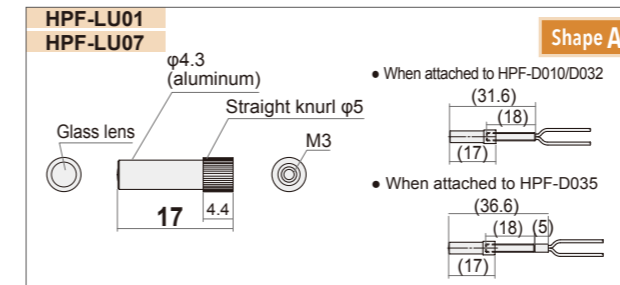

CHART

Characteristics of distance versus spot dia. (typical example)

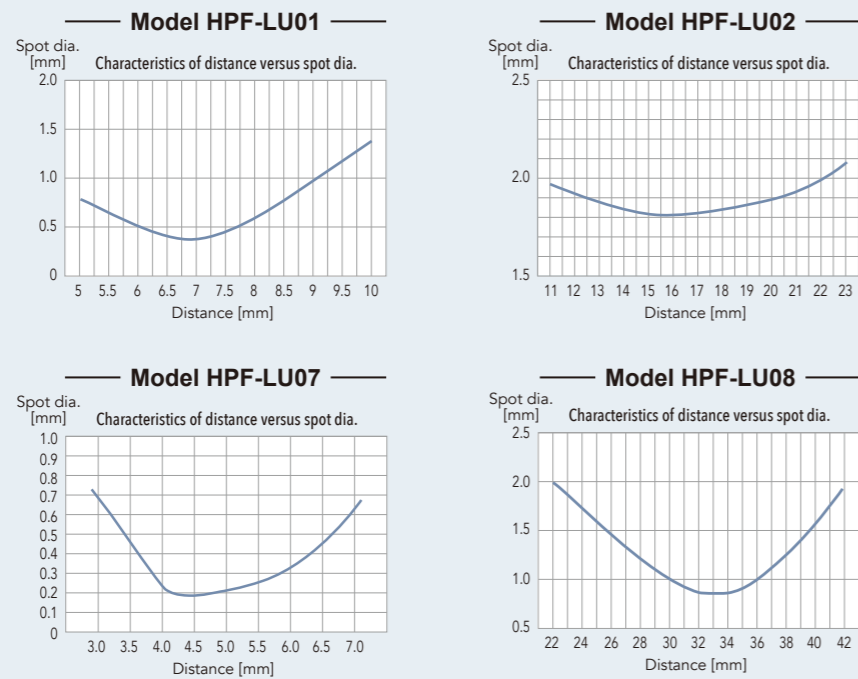

*Values are for the lens combined with an HPF-D035 fiber unit.
*Measured values are calculated at 13.5% of the peak light level. (Only HPF-LU07 is calculated at 50%.)

NOTEWORTHY

Improving detection performance yields many positive results

Because of irregular reflection inside a lens, some light is returned even when no workpiece is present, but it is a small amount compared with the light reflected when there is a workpiece.

In HPF-LU sensors, the internal wall of the lens has a special feature that keeps this internal reflection to a minimum, so there is an increased amount of difference in light level when a workpiece is actually present.

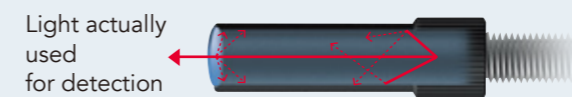

Problems due to scratches on the lens are greatly reduced.

Micro-spot lenses are made of hard glass, so problems caused by a drop in light level due to lens scratches made by collisions with workpieces can be greatly reduced.



Screw

Cylindrical

Coaxial

Sleeve

Side View

Narrow View

Flat/Selective Reflection

Area

Heat -proof

Chemical -proof

Vacuum -proof

Specialized Use

Lens Unit

Other Accessories

Technical Guide

List of Scanning Distance by Amplifiers Model

Technical Guide

List of Scanning Distance by Amplifiers Model

39

40

- Longer distances and alternate optical configurations are available by combination with thru-scan sensors.

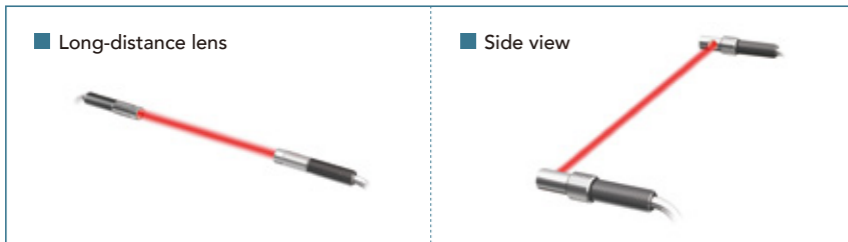

Related pages

For combined fiber units:

- P.09 (Screw)
- P.13 (Cylindrical)
- P.27 (Heatproof)
- P.31 (Vacuum-proof)

For use with thru scan

Type	Shape	Scaling	Directional angle (half angle)	Fiber unit		Scanning distance (mm)		Model No.
				Model No.	Element type	HPX-EG00/01 nL	HPX-EG50/51 HP	
Long-distance lens	Shape A	×6	3°	HPF-T003	Standard	2,460	5,640	FE-PA-L1
				HPF-T018	Heatproof	1,260	2,880	
				HPF-T025	Unbreakable	1,860	4,200	
Long-distance lens	Shape B	×10	3°	HPF-T003	Standard	4,100	9,400	HPF-VL06
				HPF-T014	Heatproof	2,200	5,100	
				HPF-T025	Unbreakable	3,100	7,000	
Side view	Shape C	-	10°	HPF-T003	Standard	410	940	FE-PA-S1
				HPF-T018	Heatproof	210	480	
				HPF-T025	Unbreakable	310	700	
Side view	Shape D	-	8°	HPF-T003	Standard	410	940	HPF-VL05
				HPF-T014	Heatproof	210	480	
				HPF-T025	Unbreakable	310	700	

The scanning distances shown are nominal values. The actual scanning distances are limited by the fiber length (approx. 2 m × 2 ≈ 4 m in the case of standard type).

For HPX-EG50/50, the scanning distance shown is for HP mode (response time: 5 ms).

For HPX-EG00/01, the scanning distance shown is for nL mode (response time: 1 ms).

The directional angles shown are typical examples obtained when the lens is combined with an HPF-T003.

Outer dimensions (differs according to the model)

Unit: mm

FE-PA-L1 Shape A

HPF-VL06 Shape B

FE-PA-S1 Shape C

HPF-VL05 Shape D

- Use in combination with various fiber units.

Product name	Shape	Description	Other specifications	Model No.
Angle adjustment bracket	Shape A	Use with a thru-scan fiber unit to limit reflection, or use as side view type brackets.	Used for M4 and M3 heads, φ4 and φ3	HPX-PA06
Fiber-optic extender	Shape B	Use to extend fibers by linking them. For scanning range see p.48.	Cable length: 5 m Bend radius: 4 mm Cuttable	HPF-EU05
			Cable length: 10 m Bend radius: 4 mm Cuttable	HPF-EU10
Small-diameter attachments (2)		Use in combination with small-dia. fiber units (supplied with applicable fiber units).	For fiber units with dia. of φ1.0	HPF-AT10
			For fiber units with dia. of φ1.3	HPF-AT13
Fiber cutter		Use to cut fiber units (supplied with applicable fiber units).	Used for cuttable fiber units.	FE-PA-F1

Outer dimensions (differs according to the model)

Unit: mm

HPX-PA06 Shape A

HPF-EU05
HPF-EU10 Shape B

Model No.	Cable length*1
HPF-EU05	5,000 mm min.
HPF-EU10	10,000 mm min.

Detection Method

Optical fiber sensor

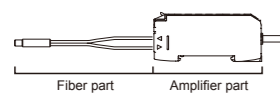

An optical fiber is composed of a central core and circumferential cladding with a low refractive index. Light travels inside the core, with repeated total reflection along the boundaries between the core and the cladding. Light emerging from the fiber is emitted and spreads out at an angle of approximately 60°.

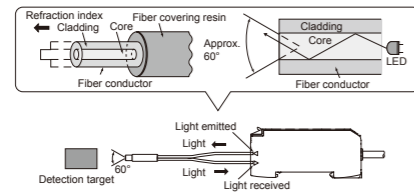

- The optical fiber does not have any electrical properties and so is excellent in an environment where reduced electrical noise is required.
- Different fiber variations allow for various applications.

Optical Fiber Types and Characteristics

	Stationary bend type (multi-core)	Standard type (single core)	Bend-tolerant type (bundle)
Cross-section			
Structure			
Features	<ul style="list-style-type: none"> • Bending causes only a small variation in the light level. • Allowable bend radius: 1 or 2 mm 	<ul style="list-style-type: none"> • Good light transmission efficiency (relatively long scanning distance) • Allowable bend radius: 10 or 20 mm 	<ul style="list-style-type: none"> • Good bend tolerance • Bend repetition of one million times or more (typical) • Allowable bend radius: 4 mm
Useful applications	Comparison with the previous standard type: <ul style="list-style-type: none"> • Soft and capable of cabling like electric wires • No worries about bend radius • Touching the fiber does not affect the light level. 	Used frequently for general purposes. Low price.	Resistant to breaks even when used in a moving environment.
Typical model number	Thru scan: HPF-T025 Diffuse scan: HPF-D030	Thru scan: HPF-T003 Diffuse scan: HPF-D002	Thru scan: HPF-T008 Diffuse scan: HPF-D037

Cutting of fibers

To cut optical fiber, use the dedicated cutter (supplied with the fiber unit). Note that cold-proof and heatproof fibers cannot be cut.

- 1 Insert the fiber into the cutter hole and set the fiber to the desired length.
- 2 Press the blade straight down in a strong smooth motion.
- 3 Cut one fiber cable at a time and do not reuse the blade on another optical fiber.

- When the detecting surface of the fiber unit gets dirty, gently wipe it with a soft clean cloth. Do not use organic solvents such as benzine or thinner.

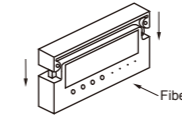

- The scanning distance may be reduced approximately 20% depending on how the fiber is inserted into the amplifier unit and how the fiber is cut.

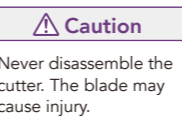

Cautions (type specific)

Vacuum fiber

Vacuum fiber model HPF-V

The flange, vacuum-side fiber unit, and the lens unit are cleaned with IPA, but baking treatment etc. should be carried out before use.

Cautions for attaching the optical coupler

The optical coupler uses an O-ring as shown below. Do not weld it to the vacuum chamber wall, as this may cloud the inside glass rod.

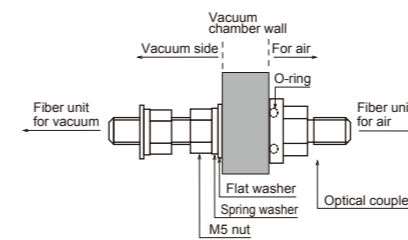

Attachable plate thickness: 8 to 10 mm
Recommended mounting hole: 5 dia. ± 0.02 mm
Recommended surface roughness for O-ring's contact area: 1.6 Ry

Use in explosive atmospheres

Generally, the fiber unit is structured only to transmit light and so cannot cause electrical explosions or ignite fires. Therefore, the fiber and amplifier units can be used with the fiber unit placed in a dangerous place, and the amplifier unit in a non-dangerous place. Nevertheless, check the explosion-proof regulations required for the equipment used before using the sensor.

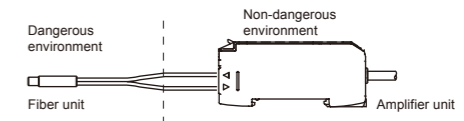

Usage Notes (general)

How to attach the amplifier unit

Attach the amplifier unit to the dedicated bracket (model HPX-PA04, supplied or sold separately) or to the DIN rail.

- 1 Insert one rail of the bracket or DIN rail into the slot at point A.
- 2 Push the unit downwards until the second rail clicks into place at point B. When attaching the amplifier to a DIN rail, be sure to secure both ends with the end plate (model HPX-PA03, sold separately).

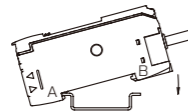

How to remove the amplifier unit

Push the amplifier forward firmly (1) so that the front lock releases. Lift the unit as shown in the figure (2) to remove the unit.

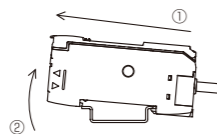

Expansion unit attachment to the main unit for reduced-wiring models (model HPX-EG)

- 1 Remove the stickers affixed to the connectors of the units to be attached.
- 2 Mount the expansion units side by side on the DIN rail.
- 3 Slide the expansion units together so that the connectors connect.
- 4 Use end plates (model HPX-PA03, sold separately) to hold the expansion units in place. To remove expansion units, slide off one by one.

Attaching the fiber unit to an amplifier

- 1 Open the cover.
- 2 Tilt the fiber clamp lever forwards to the release position.

- 3 Firmly insert the fiber tips into the holes in the amplifier as far as they will go. For the insertion depth of the fiber, refer to the mark on the side of the unit.
- 4 Close the cover.

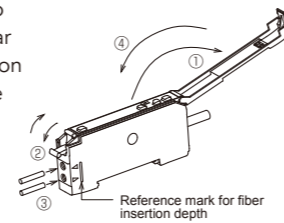

Caution

- if the fiber is thin, first insert it into the thin fiber adapter so that the fiber projects approximately 0.5 to 1 mm from the top of the adapter. Then insert the adapter into the hole in the amplifier as far as it will go, and then attach it firmly.

- Because a cable break tends to easily occur around the fiber unit's sensing head and junction with the amplifier unit, do not bend the cable within 40 mm (10 mm for a thin fiber unit). In other cabling areas, use the fiber cable at the allowed bend attach radius or more specified for each product. If the cable is bent beyond the allowed bend radius, the rated scanning distance may be unavailable or a cable break may occur.

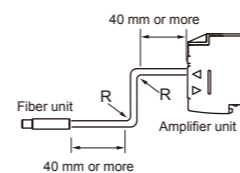

When attaching a coaxial diffuse scan fiber unit to a main unit, attach the single-core fiber cable to the insertion hole's emitter side, and attach the multi-core fiber cable to the receiver side.

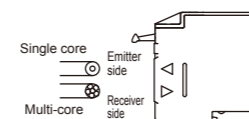

Scanning distances and display readouts may differ depending on variations in individual unit characteristics, installation states and fiber unit types.

PFA Chemical-Proof Characteristics

Substance	PFA use	Substance	PFA use
Heavy oils A/B/C	OK	Light oil	OK
Aniline	C ₆ H ₅ NH ₂ OK	Paraffinum liquidum	OK
Acrylonitrile	C ₂ H ₃ CN OK	Sodium dichromate	Na ₂ C r 2O ₇ OK
Asphalt	OK	Barium nitrate	Ba(NO ₃) ₂ OK
Acetone	(CH ₃) ₂ CO OK	Silicone oil	OK
Methanol	CH ₃ OH OK	Plant oil	OK
Ammonia	NH ₃ OK	Thinner	OK
Isooctane	i-C ₈ H ₁₈ OK	Barium hydroxide	Ba(OH) ₂ OK
Isobutyl alcohol	i-C ₄ H ₉ OH OK	Phenol	C ₆ H ₅ OH OK
Isobutyl methyl ketone	C ₄ H ₉ COCH ₃ OK	Turbine oil	OK
Ethanol	C ₂ H ₅ OH OK	Sodium carbonate	Na ₂ CO ₃ OK
Ether	(CH ₃) ₂ O OK	Turpentine	OK
Ethylene glycol	C ₂ H ₄ (OH) ₂ OK	Natural volatile oil	OK
Enamel paint	OK	Kerosine petroleum	OK
Ammonium chloride	NH ₄ Cl OK	Trichloroethane	C ₂ H ₃ Cl ₃ OK
Calcium chloride	CaCl ₂ OK	Trichlorethylene	C ₂ HCl ₃ OK
Sodium chloride	NaCl OK	Toluene	C ₆ H ₅ CH ₃ OK
Barium chloride	BaCl ₂ OK	Naphtha	C ₇ H ₁₆ OK
Chlorine	Cl ₂ OK	Acidum lacticum	OK
Gasoline	OK	Nitrobenzene	C ₆ H ₅ NO ₂ OK
Glass ingredients	OK	Hydrofluoric acid (hydrogen fluoride)	HF *
Dilute hydrochloric acid	HCl OK	Ferrosilicon	OK
Dilute sodium hydroxide	NaOH OK	Freon 11	CCl ₃ F OK
Dilute acetic acid	CH ₃ COOH OK	Propyl alcohol	C ₃ H ₅ (OH) ₃ OK
Dilute nitric acid	HNO ₃ OK	Propylene glycol	C ₃ H ₂ (OH) ₂ OK
Dilute sulfuric acid	H ₂ SO ₄ OK	Benzene	C ₆ H ₆ OK
Citric acid	C ₃ H ₄ (OH)(COOH) ₃ OK	Methyl violet	OK
Glycerin	C ₃ H ₅ (OH) ₃ OK	Water	H ₂ O OK
Cresol	C ₆ H ₄ (OH)(CH ₃) OK	Carbon tetrachloride	CCl ₄ OK
Chloroform	CH ₃ Cl OK	Ammonium sulfate	(NH ₄) ₂ SO ₄ OK

*For information on hydrofluoric acid, contact our sales staff.

Additional Notes

- The above table is not a guarantee that the product can be used with the indicated substance.
- Substances such as strong acids and ammonia may penetrate PFA (fluororesin).

Fiber Length vs. Scanning Distance Characteristics

Note that extending fiber length reduces scanning distance.

Standard fiber element

Element type		Distance change ratio for each element length						
Core dia.	Bend radius	2 m	5 m	10 m	15 m	20 m	25 m	30 m
φ0.25	4 mm	100%	62%	28%	12%	Unavailable	Unavailable	Unavailable
φ0.5	1 mm	100%	66%	33%	17%	Unavailable	Unavailable	Unavailable
	15 mm	100%	85%	64%	49%	37%	28%	21%
φ0.75	15 mm	100%	85%	64%	49%	37%	28%	21%
φ1	2 mm	100%	76%	48%	30%	19%	12%	Unavailable
	5 mm	100%	50%	16%	Unavailable	Unavailable	Unavailable	Unavailable
	20 mm	100%	85%	64%	49%	37%	28%	21%

Heatproof fiber element

Element type		Distance change ratio for each element length						
Heatproof	1 m	2 m	5 m	10 m	15 m	20 m	25 m	30 m
105 °C	-	100%	57%	22%	Unavailable	Unavailable	Unavailable	Unavailable
150 °C	-	100%	50%	16%	Unavailable	Unavailable	Unavailable	Unavailable
200 °C	100%	93%	76%	54%	38%	27%	19%	13%
350 °C	-	100%	81%	58%	41%	29%	20%	14%

Characteristics of Scanning Distance in Combination with Fiber Extender (typical values)



Thru scan

Type	Model No.	Scanning distance and cable length when combined with fiber extender: HPX-EG50/51 (HP mode: 5 ms in response time)*1		
		No extender	HPF-EU05 (5 m)	HPF-EU10 (10 m)
Standard fiber	HPF-T003 Related pages P.09	940 mm	230 mm	90 mm
		Cable length: 2 m	Cable length: 7 m	Cable length: 12 m
Heatproof	HPF-T018 Related pages P.27	480 mm	100 mm	43 mm
		Cable length: 1 m	Cable length: 6 m	Cable length: 11 m
Area	HPF-T021T Related pages P.25	2800 mm	620 mm	160 mm
		Cable length: 2 m	Cable length: 7 m	Cable length: 12 m
Unbreakable fiber	HPF-T024 Related pages P.09	110 mm	10 mm	2 mm
		Cable length: 2 m	Cable length: 7 m	Cable length: 12 m

Diffuse scan

Type	Model No.	Scanning distance and cable length when combined with fiber extender: HPX-EG50/51 (HP mode: 5 ms in response time)*1		
		No extender	HPF-EU05 (5 m)	HPF-EU10 (10 m)
Standard fiber	HPF-D002 Related pages P.13	350 mm	65 mm	27 mm
		Cable length: 2 m	Cable length: 7 m	Cable length: 12 m
Heatproof	HPF-D015 Related pages P.27	160 mm	31 mm	12 mm
		Cable length: 2 m	Cable length: 7 m	Cable length: 12 m
Unbreakable fiber	HPF-D029 Related pages P.11	22 mm	3 mm	1 mm
		Cable length: 2 m	Cable length: 7 m	Cable length: 12 m
Contact type liquid level	HPF-D027 Related pages P.33	Available	Available	Unavailable
		Cable length: 2 m	Cable length: 7 m	Cable length: 12 m

*1 For combinations other than with HPX-EG, please contact us.

*2 Even where availability is indicated, detection may not be possible depending on the liquid. Please check operation before use.

Technical Guide

List of scanning Distance by Amplifier Model

Thru scan

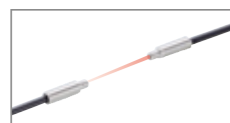

Diffuse scan



Amp Model No.	Model HPX-EG00/01			Model HPX-EG50/51			Page
	nL	SF	Ft	HP	nL	Ft	
HPF-T001	770	650	450	1700	1400	630	09
HPF-T002	770	650	450	1700	1400	630	13
HPF-T003	410	350	240	940	800	350	09
HPF-T004	410	350	240	940	800	350	13
HPF-T005	410	350	240	940	800	350	17
HPF-T006	410	350	240	940	800	350	17
HPF-T007	55	48	33	120	110	48	19
HPF-T008	60	50	38	140	120	50	09
HPF-T009	60	50	38	140	120	50	13
HPF-T010	300	250	170	660	570	240	09
HPF-T012	240	200	140	540	460	200	27
HPF-T014	220	190	130	510	440	190	27
HPF-T015	12	10	7	29	25	10	17
HPF-T017	410	350	240	940	800	350	27
HPF-T018	210	180	120	480	410	170	27
HPF-T019	1400	1200	840	3200	2700	1200	21
HPF-T020	1500	1300	920	3500	3000	1300	21
HPF-T021	270	220	160	610	520	220	25
HPF-T021S	1100	960	670	2700	2300	1000	25
HPF-T021T	1200	1000	710	2800	2400	1000	25
HPF-T021WT	2000	1600	1100	4800	4100	1700	25
HPF-T023	1200	1000	730	2800	2400	1000	21
HPF-T024	50	42	29	110	95	41	09
HPF-T025	310	260	180	700	600	260	09
HPF-T025B	310	260	180	700	600	260	09
HPF-T026	20	16	11	41	35	15	19
HPF-T028	50	42	29	110	95	41	23
HPF-T029	1500	1200	880	3500	3000	1300	29
HPF-T029E	280	230	160	640	550	240	29
HPF-T031	310	260	180	700	600	260	13
HPF-T033	280	240	160	700	600	260	09
HPF-T035	350	300	210	810	690	300	29
HPF-T036	6	5	3	14	12	5	13
HPF-T037	20	16	11	41	35	15	19
HPF-T038	12	10	7	29	25	10	13
HPF-T039	6	5	3	14	12	5	17
HPF-T042	220	190	130	510	440	190	19
HPF-T043	100	80	55	230	200	85	13
HPF-T044	220	190	130	520	450	190	09
HPF-T046	60	50	38	140	120	50	13
HPF-T054-I05	6	6	6	6	6	6	23

Amp Model No.	Model HPX-EG00/01			Model HPX-EG50/51			Page
	nL	SF	Ft	HP	nL	Ft	
HPF-D001	210	180	120	470	400	170	11
HPF-D002	150	130	90	350	300	130	11
HPF-D003	150	130	90	350	300	130	17
HPF-D004	43	36	25	90	80	35	11
HPF-D005	43	36	25	90	80	35	13
HPF-D006	43	36	25	90	80	35	17
HPF-D009	150	130	90	350	300	130	15
HPF-D010	35	30	21	75	65	28	15
HPF-D011	17	14	10	35	30	13	19
HPF-D012	100	80	55	220	190	80	11
HPF-D013	100	80	55	190	190	85	27
HPF-D014	50	50	50	50	50	50	29
HPF-D015	85	70	50	160	160	75	27
HPF-D018	75	65	46	170	150	65	11
HPF-D019	8	7	5	18	16	7	17
HPF-D021	35	30	21	75	65	28	17
HPF-D022	150	130	90	350	300	130	27
HPF-D025	20	20	20	20	20	20	21
HPF-D026	100	90	60	230	200	85	25
HPF-D028	2.5±0.5	2.5±0.5	—	2.5±0.5	2.5±0.5	2.5±0.5	24
HPF-D028F	5.2±1.0	—	—	5.2±1.6	5.2±1.6	—	24
HPF-D028T	7.4±1.2	—	—	7.4±1.6	7.4±1.6	—	24
HPF-D029	10	8	5	22	19	8	11
HPF-D030	85	70	50	180	160	70	11
HPF-D032	18	15	10	41	35	15	15
HPF-D032B	18	15	10	41	35	15	15
HPF-D034	25	21	15	50	45	19	15
HPF-D035	50	42	29	95	95	43	15
HPF-D036	8	7	5	17	15	6	13
HPF-D037	8	7	5	17	15	6	11
HPF-D038	50	42	29	95	95	43	15
HPF-D039	8	7	5	18	16	7	17
HPF-D041	17	14	10	35	30	13	19
HPF-D042	35	30	21	75	65	28	15
HPF-D043	65	55	40	140	120	50	19
HPF-D045LF	37	31	21	80	70	30	23
HPF-D049	60	55	38	150	120	55	15

- Screw
- Cylindrical
- Coaxial
- Sleeve
- Side View
- Narrow View
- Flat/Selective Reflection
- Area
- Heat -proof
- Chemical -proof
- Vacuum -proof
- Specialized Use
- Lens Unit
- Other Accessories

Characteristic diagrams (typical examples)

Excess gain

HPF-T003

Related pages [P.09](#)

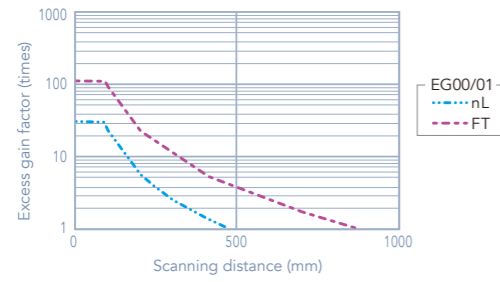

HPF-T003/ FE-PA-L1

Related pages [P.09](#) [P.41](#)

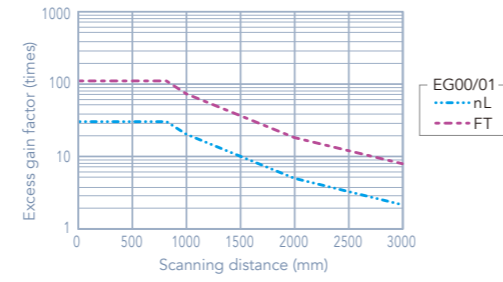
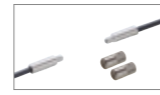

HPF-T029

Related pages [P.29](#)

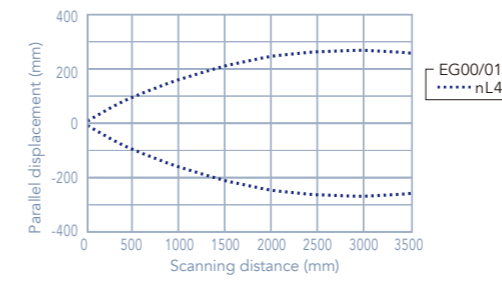

HPF-D002

Related pages [P.11](#)

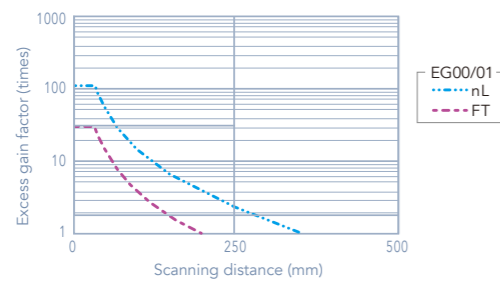

Detection area characteristics

HPF-D002

Related pages [P.11](#)

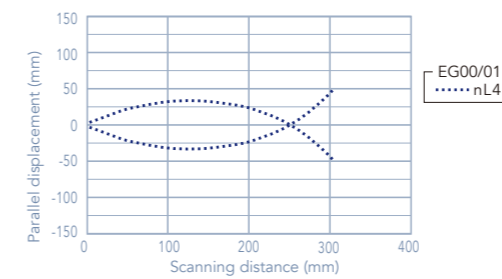

HPF-D025

Related pages [P.21](#)

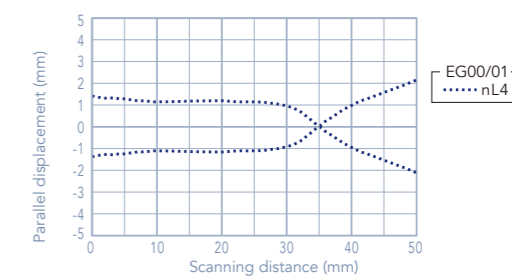

Parallel displacement

HPF-T003

Related pages [P.09](#)

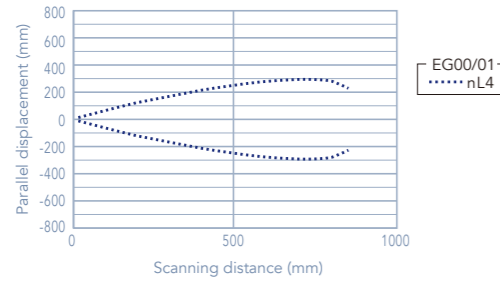

HPF-T003/ FE-PA-L1

Related pages [P.09](#) [P.41](#)

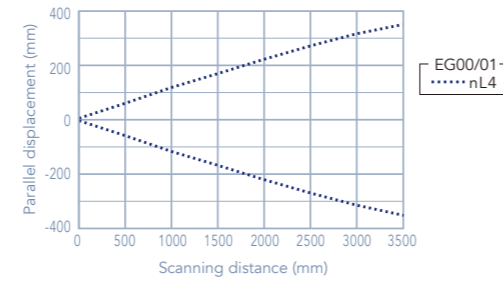

HPF-T021T

(Right and left detection)

Related pages [P.25](#)

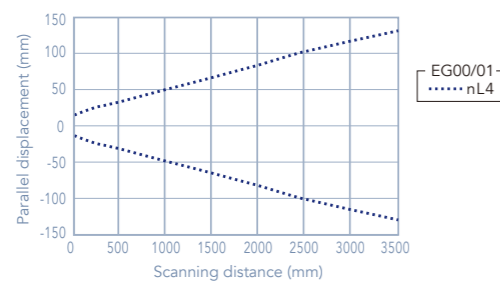

HPF-T021T

(Up and down detection)

Related pages [P.25](#)

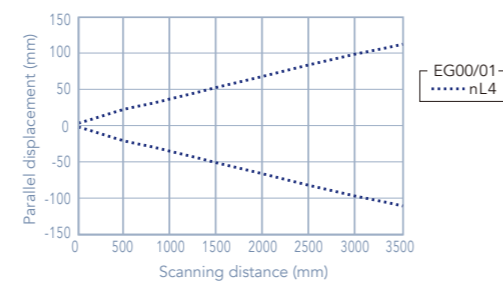
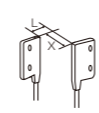

- Screw
- Cylindrical
- Coaxial
- Sleeve
- Side View
- Narrow View
- Flat/Selective Reflection Area
- Heat-proof
- Chemical-proof
- Vacuum-proof
- Specialized Use
- Lens Unit
- Other Accessories