



# Environment-Resistant Switches

## Excellent performance in harsh metalworking environments

Photoelectric switches

Proximity switches

Limit switches

Highly penetrating water-soluble coolants have serious effects on the resin and rubber materials used in many kinds of switches. Cracking of resin materials and cracking of rubber materials due to swelling or hardening, together with corrosion and breaking of springs, all of which normally occur due to deterioration with age, are increasingly occurring in a shorter period of time, necessitating early product replacement. Azbil offers various switches equipped with countermeasures against highly penetrating water-soluble coolants.



Model H2B



Model 1LS-J700SEC-MD03

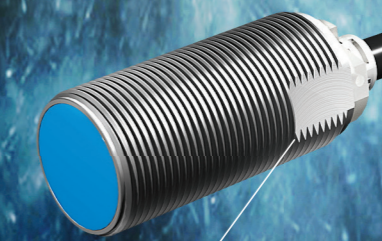

Model FL7M-1000-C



Model SL1-100-C

Please read "Terms and Conditions" from the following URL before ordering and use.

<https://www.azbil.com/products/factory/order.html>

HART is a registered trademark of HART Communication Foundation. Other product names, model numbers and company names may be trademarks of the respective company.

[Notice] Specifications are subject to change without notice. No part of this publication may be reproduced or duplicated without the prior written permission of Azbil Corporation.

**Azbil Corporation**  
Advanced Automation Company

*Yamatate Corporation changed its name to Azbil Corporation on April 1, 2012.*

1-12-2 Kawana, Fujisawa  
Kanagawa 251-8522 Japan

URL: <https://www.azbil.com>

1st Edition : Sep. 2016-Y  
2nd Edition: Oct. 2019-AZ

### Coolant immersion test (500-hour accelerated product life test)

Oil type	JIS classification	Oil name	Model H2B	Model FL7M-1000-C
Water-soluble cutting fluid (emulsion)	A1 No.1 equivalent	EC50-T3	Pass	Pass
Water-soluble cutting fluid (soluble/synthetic)	A2 No.1 equivalent	PFS760	Pass	Pass

# Anti-Coolant Countermeasures

## Photoelectric switches

**Problems** ▶ Mist coolants are often used near photoelectric sensors. Since most sensors are made of resin, coolant intrusion through cracks in the case or lens, attenuation of light intensity, and similar problems occur after a short period of time, and the number of such cases is increasing.

### Structural reinforcement to resist coolants

Protection for switch housing

Protection for optical parts

Protection for cable interior

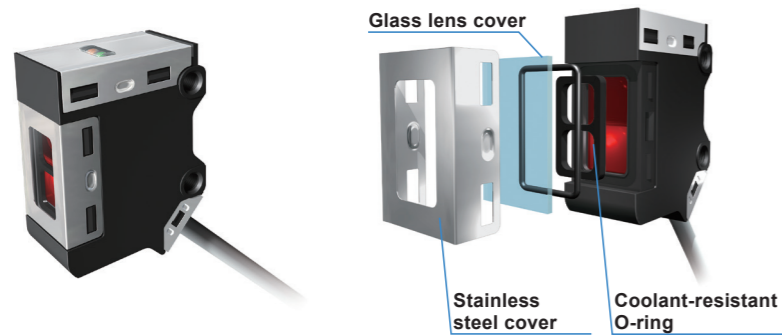

**Cable port**  
High sealing performance by press-fit NBR seal

Before press fitting After press fitting

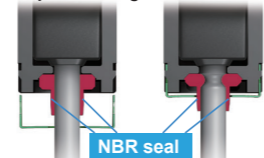

**Cable interior**  
Epoxy potting prevents water intrusion

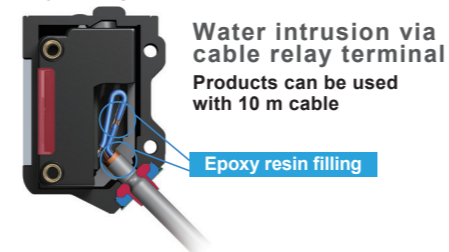

### Model H2B environment-resistant photoelectric switches

- No more need to worry about cracked cases or attenuation of light due to lens fogging
- High sealing performance ensures normal operation even after 500-hour immersion heat cycle test

## Proximity switches

**Problems** ▶ Disconnection following cable deterioration and hardening  
Cable failure, etc. caused by coolant penetration  
The number of problems occurring after a short period of time is increasing.

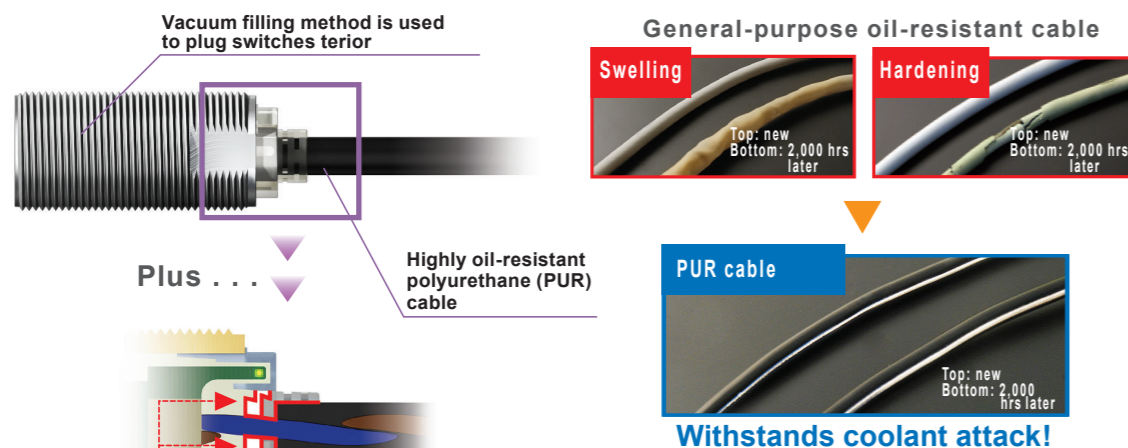

The cable is securely bonded to the molded material at the end of the cable and to the filler material (indicated by red lines). This is very effective in preventing any coolant that has penetrated the cable from reaching the main circuit board.

### Model FL7M-\_\_\_C environment-resistant proximity switches

- Greatly enhanced sealing performance through elimination of cable deterioration caused by water-soluble coolants
- Resistance to cable hardening has been significantly improved
- Passes coolant immersion test (500 hours at 70 °C)

## Limit switches

**Problems** ▶ Internal plunger cup seal deteriorates, causing insulation failure  
Springs break due to corrosion, causing faulty operation  
The number of problems occurring after a short period of time is increasing.

Integrally molded seal (pin/rubber)  
Structure that does not easily crack during sliding  
Coolant is shut out

Cobalt alloy C springs resist corrosion

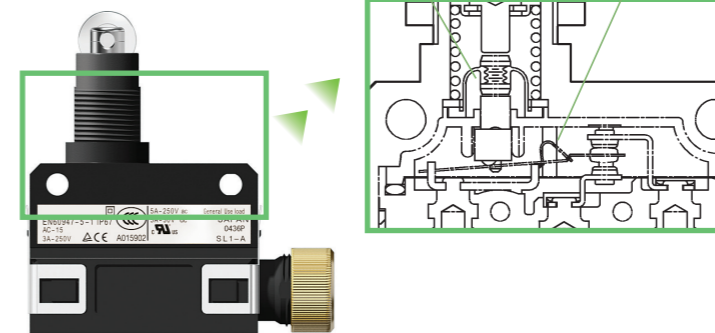

Various types are available

Model	Actuator type
SL1-AC	Roller plunger
SL1-BC	Boot seal roller plunger
SL1-DC	Cross roller plunger
SL1-EC	Long roller plunger
SL1-HC	Plunger
SL1-PC	Short roller lever

### Model SL1-\_\_C environment-resistant limit switch

- New cup seal shape remedies problem of cracking followed by insulation deterioration
- Cobalt alloy C springs resist corrosion by coolant

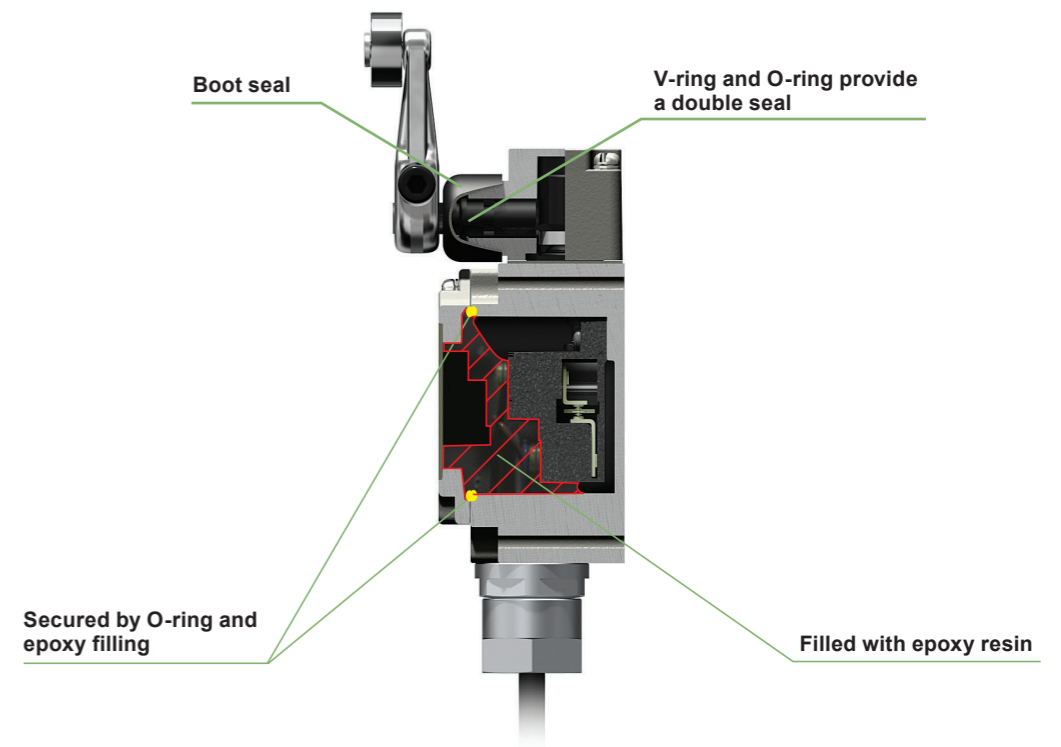

### Model 1LS-J\_\_\_MD03 environment-resistant limit switch

- V-ring and O-ring between the head and shaft provide a double seal
- The internal switch terminals, the cable core, and the conduit section are filled with epoxy resin after the connector is tightened
- The joint between the housing and cover is sealed by O-ring and epoxy resin filling