

**MagneW 3000 FLEX**  
**Electromagnetic Flow Switch**  
**Integral Type,**  
**Remote Type Converter**  
**Model MGF**  
**User's Manual**



Azbil Corporation

# Copyright, Notices and Trademarks

---

Printed in Japan - © Copyright 2014-2024 by Azbil Corporation.

While this information is presented in good faith and believed to be accurate, Azbil Corporation disclaims the implied warranties of merchantability and fitness for a particular purpose and makes no express warranties except as may be stated in its written agreement with and for its customer.

In no event is Azbil Corporation liable to anyone for any indirect, special or consequential damages, The information and specifications in this document are subject to change without notice.

MagneW3000 is a trademark of Azbil Corporation.

---

**Preface**

Thank you for purchasing Azbil Corporation MagneW 3000 FLEX Electromagnetic Flow Switch. Model MGF electromagnetic flow switches, fruit of our long experience and outstanding performance, are designed for uses for cooling water, generator coolers, and hydraulic turbine sealing water. They are multifunction convertors characterized by a wide range of applications and easy field operations.

---

# Unpacking and Inspecting Your Product

---

## Unpacking the product

This device is a precision instrument and should be handled with care to prevent damage or breakage.

After unpacking the device, verify that the following items are included:

- Flow Switch itself
  - Standard accessories
  - MagneW Setting Data Sheet
  - Test report
- 

## Verifying the specifications

The specifications of this device are written on its attached identification plate. Compare these specifications with those listed in the Appendix, "System Standard Specifications and Model Numbers," and verify that all specifications on the plate are correct, paying special attention to the following:

- Basic model number
  - Power supply
- 

## Inquiries

If you have any questions regarding the specifications of this device, contact your nearest Azbil Corporation office or Azbil Corporation representative. When making an inquiry, make sure to provide the model number and product number of this device.

---

## Storage precautions

When storing this device before use, observe these precautions:

- Store it indoors at room temperature and humidity, in a place safe from vibration or shock.
- Store it in the same condition as it was shipped.

When storing this device after use, follow these steps:

1. Attach the display cover, the terminal box cover, and the water-proof gland to keep out moisture.
  2. Replace the product in its original packaging.
  3. Store it indoors at normal temperature and humidity and in a place safe from vibration or shock.
-

# Safety Precautions

---

## Introduction

Correct installation, correct operation and regular maintenance are essential to ensure safety when using this device. Don't use the system, before reading and understanding the safety precautions described in this manual and be sure to follow the instructions on installation, operation and maintenance.

---

## Signal words

Two kinds of safety precaution are used in this manual —Warning and Caution. The meaning of these is as follows:



### **Warning**

Potentially hazardous situation which, if not avoided, could result in death or serious injury.



### **Caution**

Failure to observe these precautions may produce dangerous conditions that could result in injury to the user or in physical damage.

---

# How this Manual is Organized and Used

---

## **Organization and Method of Use**

This user's manual explains the use of the system and its associated devices in the following order:

### **Chapter 1**

This chapter explains the configuration of measuring systems based on this product, the structure of this product and the names and functions of their respective parts.

### **Chapter 2**

This chapter explains the installation and wiring of the system. Persons in charge of the installation of this unit, the piping installation, and the wiring should refer to this chapter.

### **Chapter 3**

This chapter explains the procedures for starting-up, operating, and stopping this product. Two operating methods are explained; one uses the data setting device of this product. Read this chapter when using this product just after installation or after the operation of this product has been halted.

### **Chapter 4**

This chapter explains the operation of this product using the data setting device.

### **Chapter 5**

This chapter describes the procedures to be followed for maintenance and checking of this unit and for troubleshooting. Refer to this chapter when performing maintenance and troubleshooting.

---

# Detailed Table of Contents

---

<b>Chapter 1 -</b>	<b>Configuration and Structure of the Measuring Systems .....</b>	<b>1 - 1</b>
	Outline of this chapter .....	1 - 1
1.1	System Configuration .....	1 - 2
	Measuring System .....	1 - 2
1.2	Structure of this Unit and Functions of Parts .....	1 - 4
	Structure of the Device .....	1 - 4
<b>Chapter 2 -</b>	<b>Installing the Device .....</b>	<b>2 - 1</b>
	Outline of this chapter .....	2 - 1
2.1	Before Installation .....	2 - 2
	Selecting the Installation Site (1) .....	2 - 2
2.2	Installation Method .....	2 - 3
	Installing the Converter .....	2 - 3
	Electrical Wiring (1) .....	2 - 5
	Electrical Wiring (2) .....	2 - 7
	Electrical Wiring (3) .....	2 - 10
	Electrical Wiring (4) .....	2 - 11
<b>Chapter 3 -</b>	<b>Operating and Stopping of the Measuring System .....</b>	<b>3 - 1</b>
	Outline of this chapter .....	3 - 1
3.1	Start-up .....	3 - 2
3.2	Preparations before Measurement .....	3 - 3
	Zero Adjustment (1) .....	3 - 3
	Method Using the Data Setting Device .....	3 - 4
3.3	Stopping .....	3 - 6
3.4	Setting Write Protection .....	3 - 7
<b>Chapter 4 -</b>	<b>Operation Using the Data Setting Device .....</b>	<b>4 - 1</b>
	Outline of this chapter .....	4 - 1
4.1	Functions of the Data Setting Device .....	4 - 2
	Data Setting Device .....	4 - 2
	Operating the Display/Data Setting Device .....	4 - 5
	Screen Organization .....	4 - 7
	Measuring Mode .....	4 - 9
	How to Skillfully Operate the Touch Key Switches .....	4 - 10
	How to Enter the Operator's Mode .....	4 - 11
	Operating in Operator's Mode .....	4 - 12
	Resetting the Damping Time Constant .....	4 - 13
	Zero Adjustment .....	4 - 14
	Setting/Changing the Flow Rate Indication .....	4 - 16
	Selecting Modes .....	4 - 17
	Engineering Mode .....	4 - 19
	Setting the ID .....	4 - 20
	Detector Data Setup .....	4 - 21
	Setting the Range .....	4 - 23
	Setting the Specific Gravity .....	4 - 24
	Setting alarm contact 1 .....	4 - 25
	Setting alarm contact 2 .....	4 - 26
	Setting alarm hysteresis .....	4 - 27

---

Maintenance Mode .....	4 - 28
------------------------	--------

<b>Chapter 5 -</b>	<b>Maintenance and Troubleshooting of the Electromagnetic Flowmeter .....</b>	<b>5 - 1</b>
	Outline of this chapter .....	5 - 1
5.1	Functions Check .....	5 - 2
	Checking alarm contact output .....	5 - 2
	Checking the Excitation Current .....	5 - 3
	False Signal Input by Calibrator .....	5 - 4
5.2	Troubleshooting .....	5 - 5
	Overview .....	5 - 5
	Errors at Start-up .....	5 - 6
	Errors during Operation .....	5 - 7
	Error Messages and Treatment (Display) .....	5 - 8



# Chapter 1 - Configuration and Structure of the Measuring System

---

## Outline of this chapter

This chapter explains the configuration of measuring systems using this unit.

- The structure of this unit and the names and functions of its respective parts are explained.
-

# 1.1 System Configuration

## Measuring System

### Introduction

Depending on the way it is combined with the detector, this product is available in two configurations; integral and remote.

- Integral: detector and converter are installed as an integrated unit on the pipe.
- Remote: detector and converter are installed separately and connected by a cable.

### Examples of flow measurement systems

Figures 1-1 and 1-2 show examples of measurement systems using the device.

Figure 1-1 Integral configuration

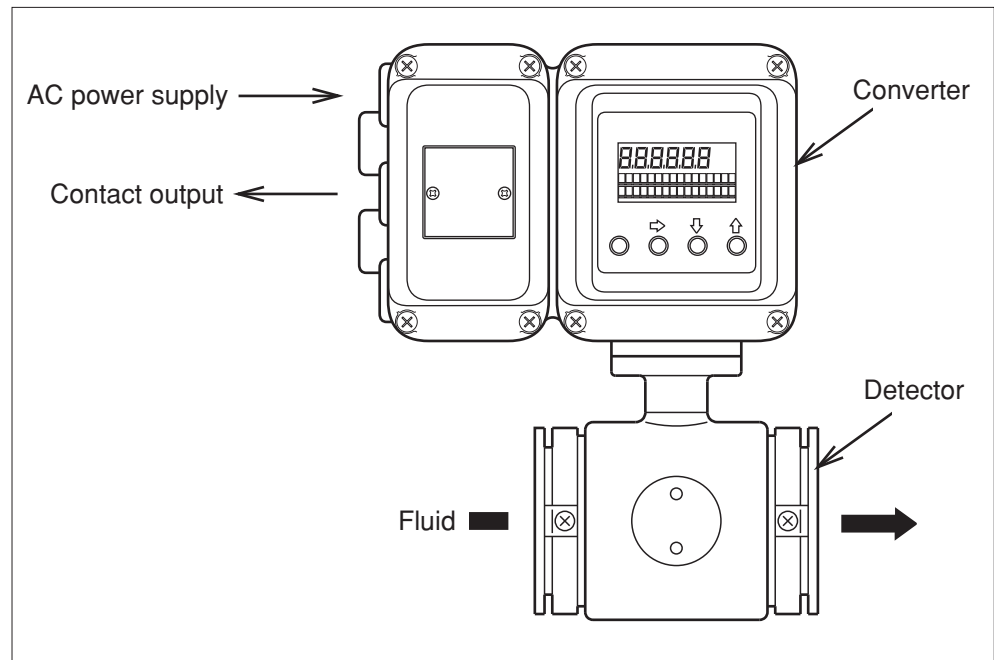

(Continued on next page)

# Measuring System *(Continued)*

## Examples of flow measurement systems

Figure 1-2 Remote configuration

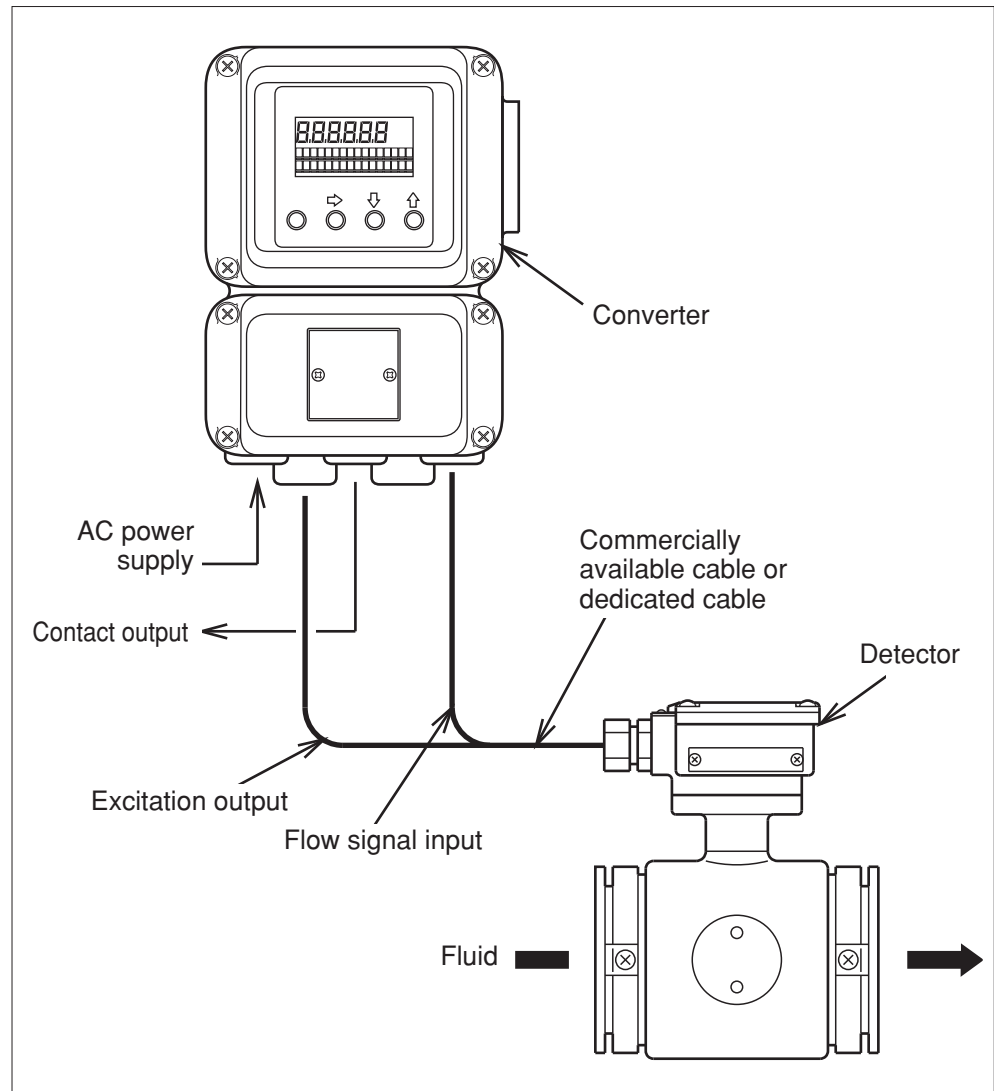

## 1.2 Structure of this Unit and Functions of Parts

### Structure of the Device

#### Main components

This unit consists of the converter main body, the contact I/O card, data setting device, and a terminal box.

Figure 1-6 Structure of the main body

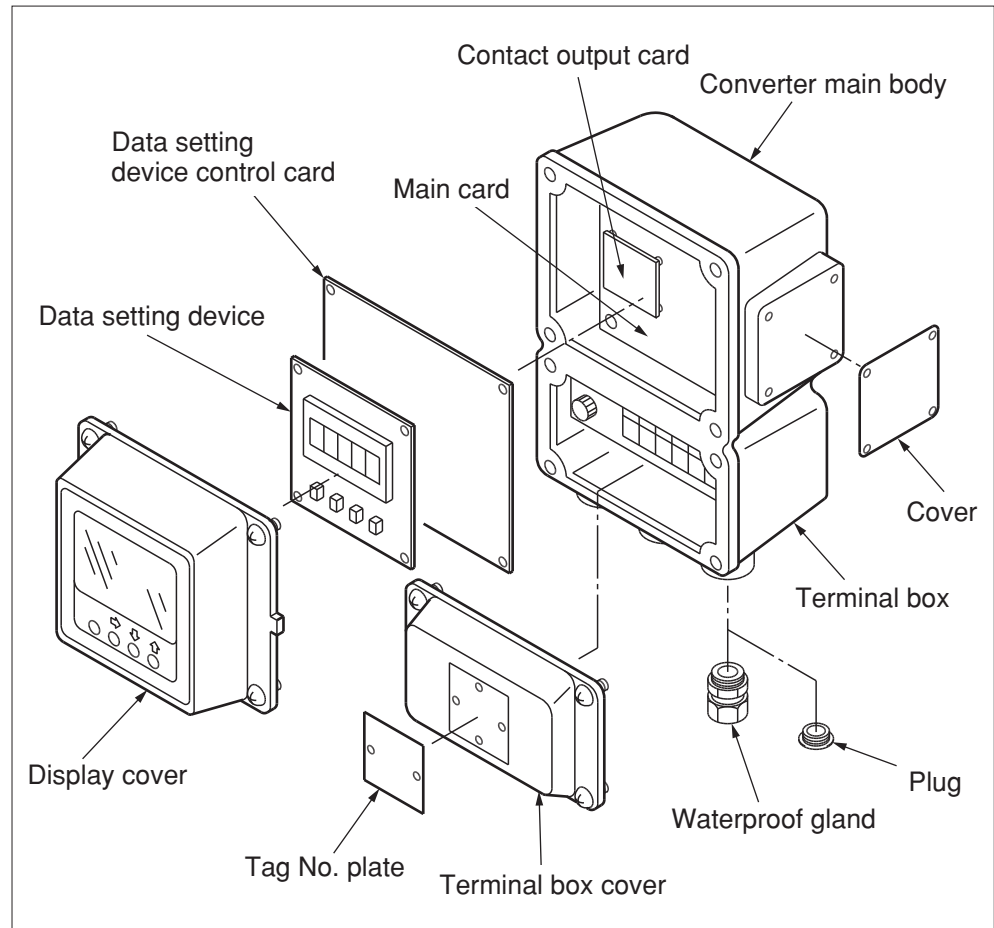

(Continued on next page)

## Structure of the Device *(Continued)*

### Converter parts and explanation

The following table explains the various parts.

Name	Explanation
Converter main body	<ul style="list-style-type: none"><li>• Converts signal electromotive force generated in the detector into the instantaneous flow rate.</li></ul>
Data setting device	<ul style="list-style-type: none"><li>• Indicates the instantaneous flow rate.</li><li>• The flowmeter functions can be changed using the four keys on the panel.</li></ul>
Terminal box	<ul style="list-style-type: none"><li>• Encloses the input/output terminals.</li><li>• Contains an integrated 12 kV, 100 A isolator.</li></ul>
Nameplate	<ul style="list-style-type: none"><li>• Indicates model number, the product number, and the detector constant (EX) .</li></ul>
Tag No. plate	<ul style="list-style-type: none"><li>• Indicates tag number as specified in the product order.</li></ul>

# MEMO

## Chapter 2 - Installing the Device

---

### Outline of this chapter

This chapter explains the installation and wiring procedures of the device in the following order.

- Selecting the installation site
  - Adjusting the data setting device direction
  - Installing the device
  - Signal line wiring
-

## 2.1 Before Installation

---

### Selecting the Installation Site (1)

---

#### Introduction

In order to make full use of the device functions, please observe the following criteria when selecting an installation site.

#### Notes :

- Install the product in a location with an ambient temperature of  $-25^{\circ}\text{C}$  -  $+60^{\circ}\text{C}$  and an ambient humidity of 5 - 100% RH to prevent equipment malfunction or output errors.
  - Avoid installing the product near high-current power lines, motors, or transformers to prevent damage from electromagnetic induction, which may cause equipment malfunction or output errors.
  - DO NOT use this product for grounding a welder, as it may cause damage to the product.
  - When welding near this product, be sure to ground the welding power transformer.
  - Avoid locations subject to severe vibration or highly corrosive atmospheres to prevent detector breakage or equipment damage.
  - Keep the product away from direct sunlight, wind, and rain to prevent output errors.
-



## 2.2 Installation Method

### Installing the Converter

#### Basic installation method Installation

A converter can be mounted in one of four ways, an integrated unit with a sensor and an elbow, an integrated unit, mounting on a wall and mounting on a 2-inch pipe.

Figure 2-1 Wall-mounted

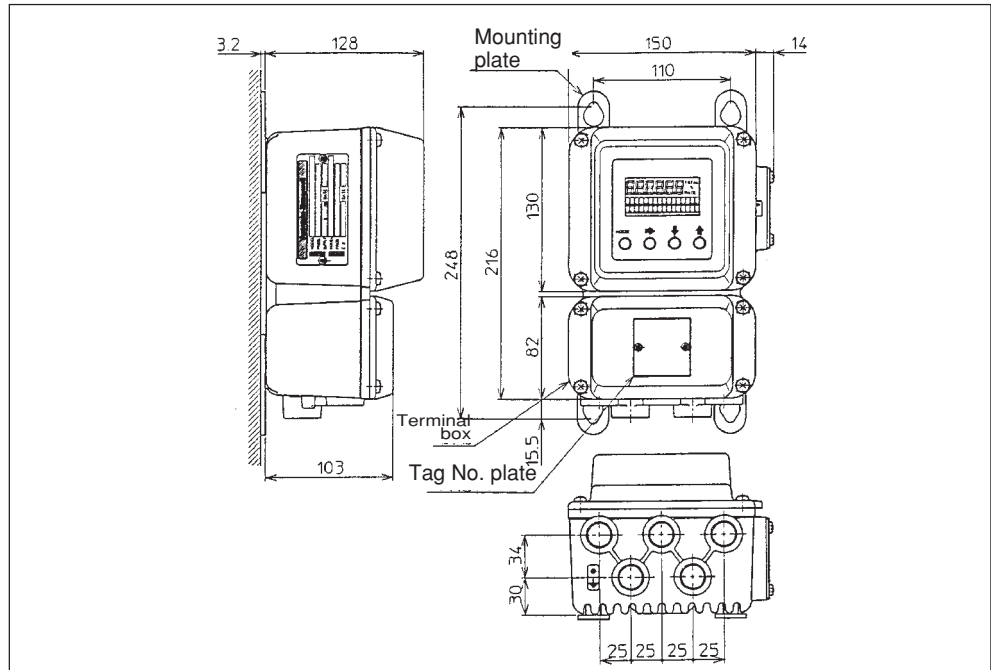
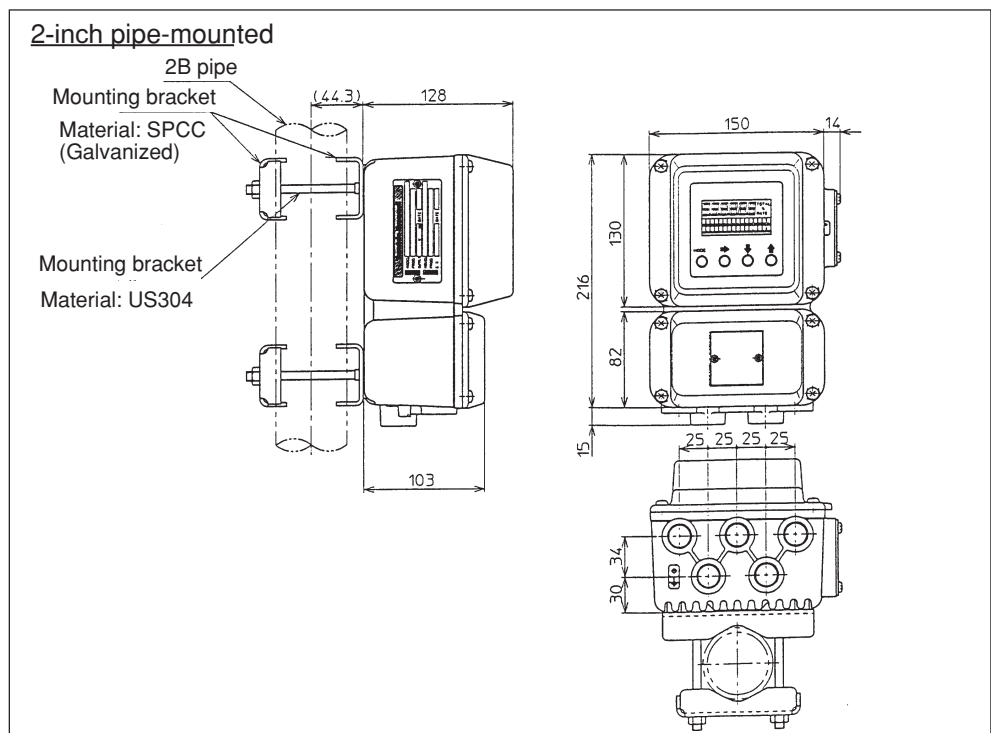

Figure 2-2 2-inch pipe-mounted



(Continued on next page)

# Installing the Converter *(Continued)*

Basic installation  
method  
Installation

Figure 2-3 Integral assembly

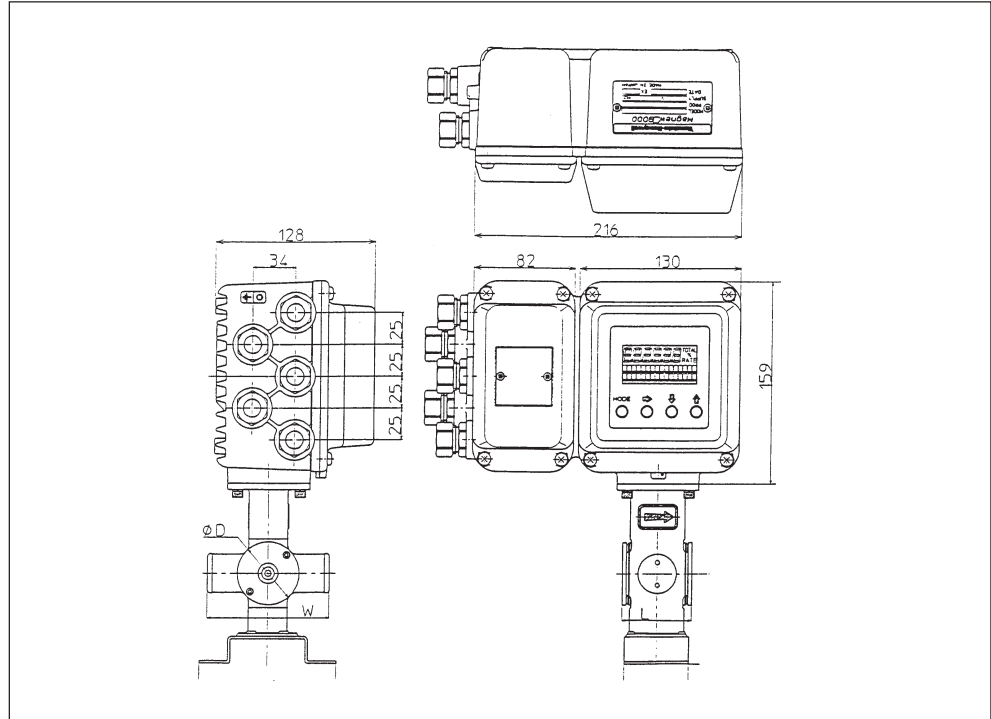
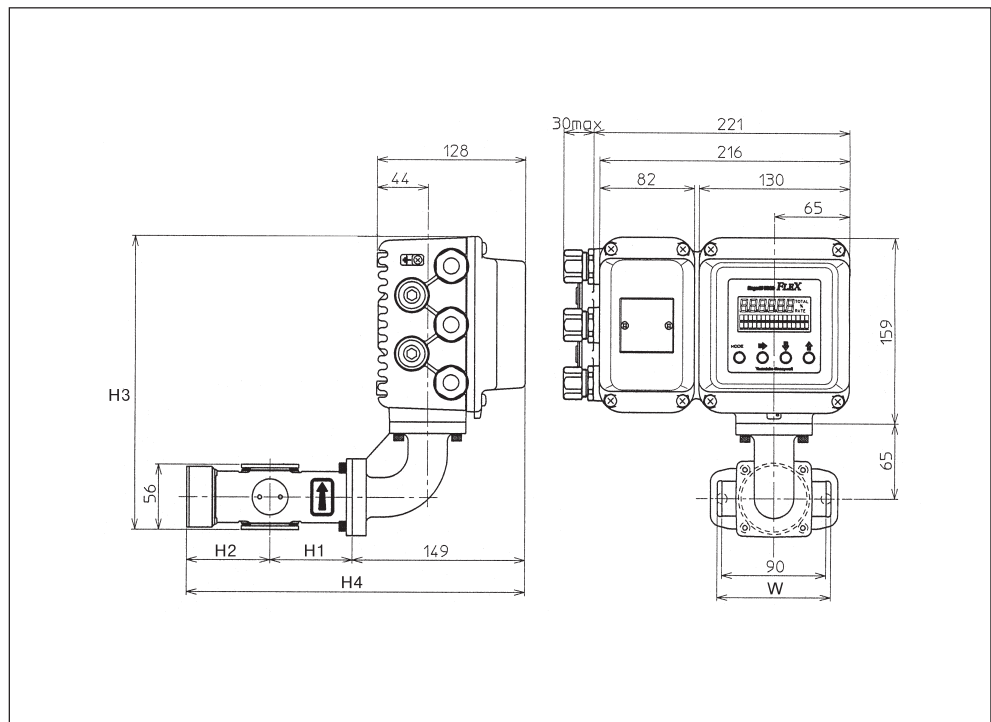

Figure 2-4 Mounting of Integrated Type with an Elbow



# Electrical Wiring (1)

---

## Introduction

A commercial power supply or DC 24 V  $\pm$  10% power supply is used. The following electrical wiring considerations are explained here.

- Cable connection positions
  - Power supply and resistive load
  - Cable selection and installation
  - Grounding
  - Wiring procedure
- 

## Connecting positions for the electromagnetic flowmeter main body

Figure 2-5 (below) shows the terminal block of the electromagnetic flowmeter main body.

 <b>Warning</b>
--

- |   |
|---|
| <ul style="list-style-type: none"><li>• During wiring, turn OFF the power supply before opening the cover in order to prevent the danger of electric shock.</li><li>• DO NOT perform wiring work while the power is ON, as it may result in electric shock.</li></ul> |
|---|

Notes :

- Perform wiring according to the directions in order to prevent equipment damage.
  - Be sure to check the power line wiring positions carefully, as a high-voltage power flow is used.
- 

*(Continued on next page)*

# Electrical Wiring (1) *(Continued)*

Terminal  
arrangement

## 2-contact output

E	⊕	AL1			AL2		SB	SA	C	A
		NC	NO	C	C					
POWER		X	Y	AL2						B
+	-			NC	NO					

Terminal arrangement for integral converter

On an integral converter, terminal symbols X, Y, SB, SA, A, B, C, and E are not indicated as on the remote converter, because these terminals are not used.

## Electrical Wiring (2)

### Cable between detector and converter

Use a dedicated cable (Model: MGA12W) to connect the detector to the converter. The signal cable used may be a dedicated cable made by Azbil Corporation or a commercially available cable and depends on fluid conductivity, cable length, and the diameter of the detector.

Please refer to the following:

- Dedicated Azbil Corporation cable usage range: ranges (A) and (B)
- Other cable usage range: (A) only

Figure 2-5 Relation between fluid conductivity and cable length

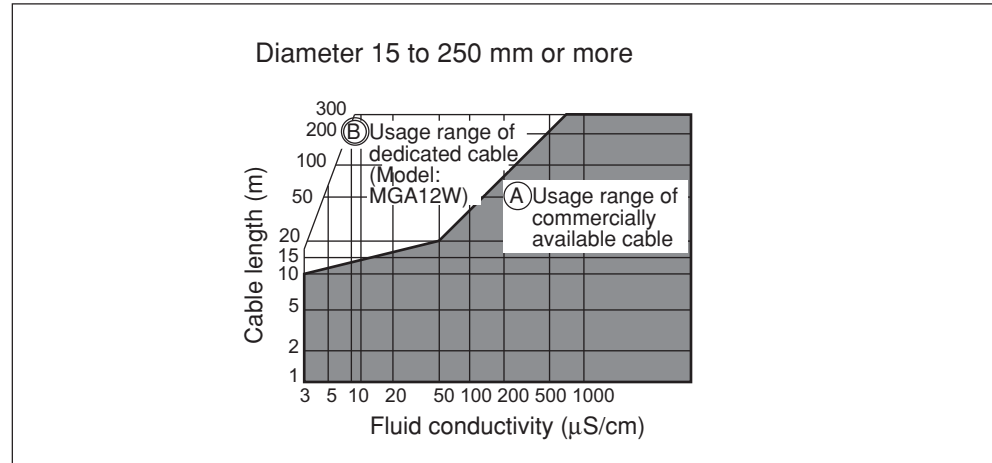

### Cable specifications

Cable (between remote detector and converter):

Length: Max. 300 m (Depends on fluid conductivity)

Outer diameter: 10 - 12 mm

Signal cable:

Dedicated cable (Diameter 11.4 mm, 0.75 mm<sup>2</sup>) or equivalent commercially available cable (e.g. CVVS, CEEV)

Excitation cable:

Dedicated cable (Diameter 10.5 mm, 2 mm<sup>2</sup>) or equivalent commercially available cable (e.g. CVV)

Note: Be sure to use shielded cables for signal cables.

(Continued on next page)

# Electrical Wiring (2) *(Continued)*

Signal Cables  
(Model: MGA 12W)

Figure 2-6 Outer Dimensions of Signal Cables

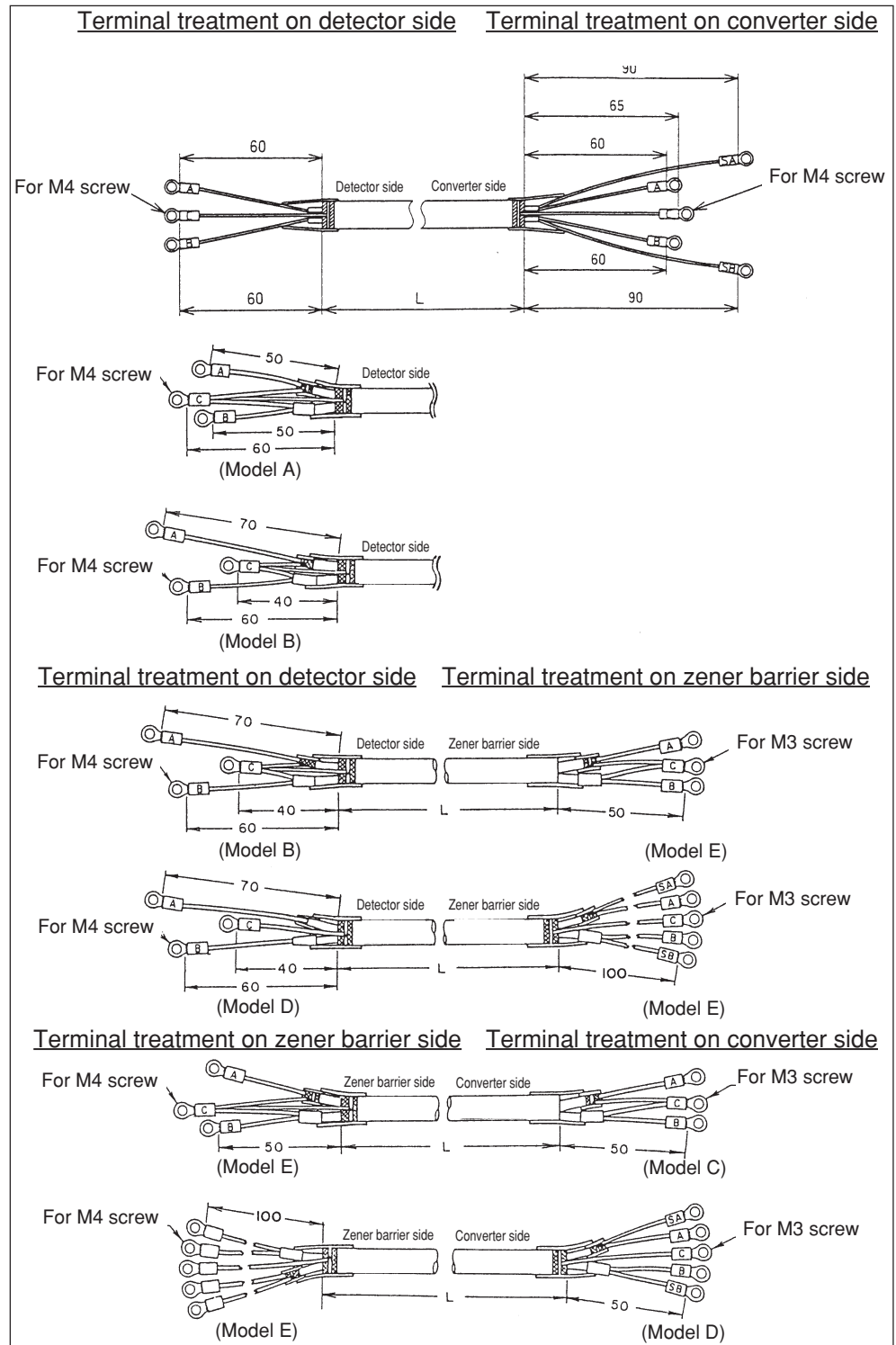
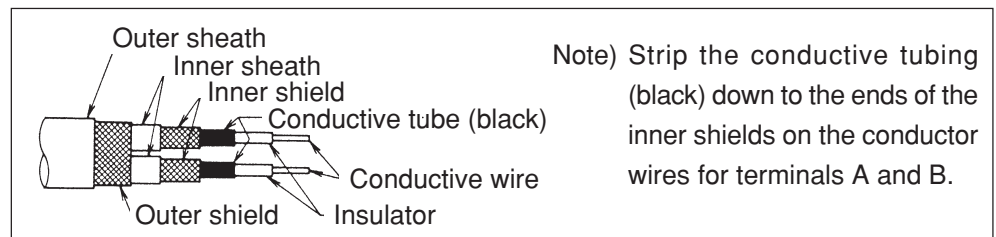

Figure 2-7 Signal Cable Construction



*(Continued on next page)*

# Electrical Wiring (2) *(Continued)*

## Excitation Cables (Model: MGA 12W)

Figure 2-8 Outer Dimensions of Excitation Cables

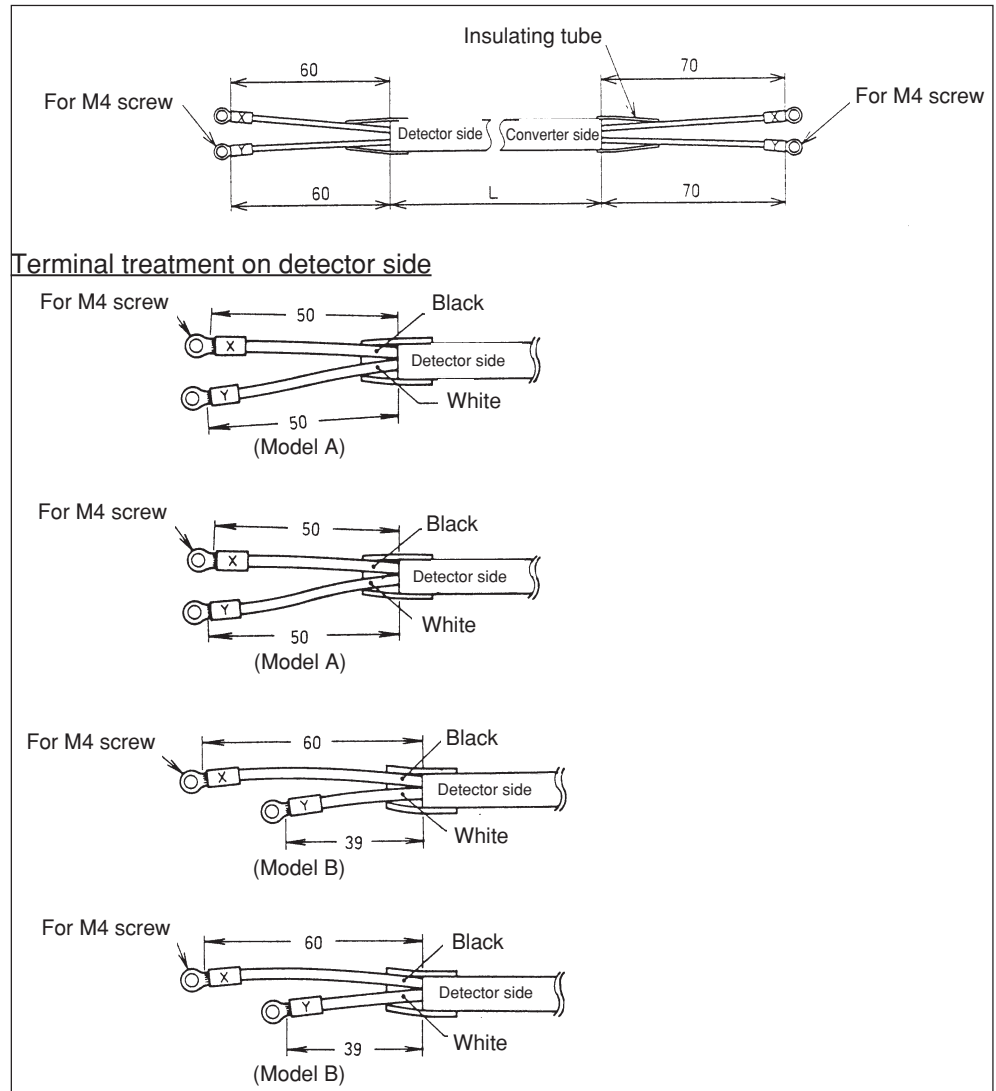
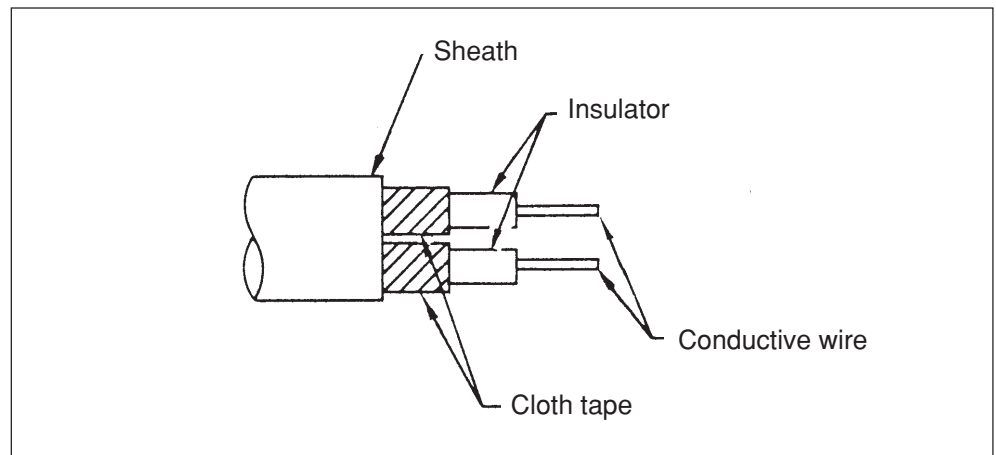

Figure 2-9 Excitation Cable Construction



# Electrical Wiring (3)

## Detector-to-converter connection

Figure 2-10 Detector-to-converter connection

- Wiring of dedicated cables (Model: MGA12W)

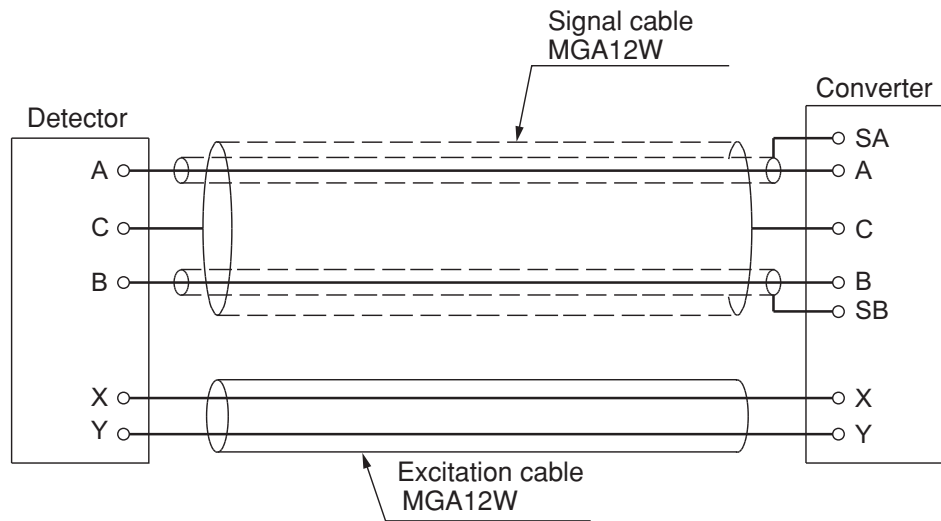

- Commercially available cable

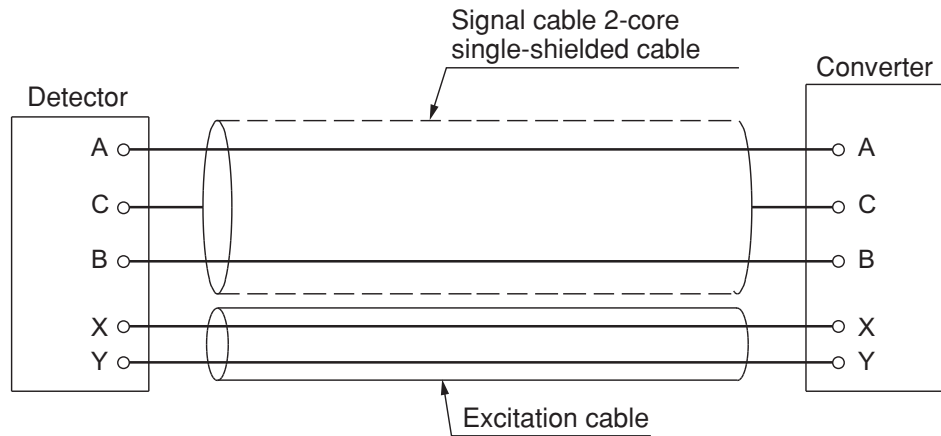



## Electrical Wiring (4)

---

### Selecting the wiring cable

The recommended wiring cable is a 600 V vinyl sheath electrical wire CVV (JIS C 3401) with a conductor section of 2 mm<sup>2</sup>, or a twisted cable with an equivalent or higher capacity.

Shielded wire is recommended for wiring at locations subject to electromagnetic noise interference.

Select a sheath material suitable for the cable installation environment (consider ambient temperature, corrosive gas, corrosive fluid, etc.).

Run the cable into the terminal block through the conduit connection (G1/2 internal thread, CM20 external thread, Pg13.5 or 1/2NPT internal thread). An outer diameter of  $\phi 11$  is optimum. (The applicable range of cable outer diameters is  $\phi 10 - \phi 12$ .)

A crimp terminal (M4 screw) with an insulation sleeve is recommended for the terminal connections.

The maximum length of the wiring cable is 1500 m. However, the maximum length between converter and detector is 300 m.

---

### Installing the wiring cable

When installing the cable connecting this product to the control equipment, the following precautions must be observed.

#### Notes:

- Run the wiring away from equipment that may cause noise, such as high-capacity transformers, motors, or power supplies. DO NOT install the cable in the same tray or duct as other power cables. Output errors may result.
  - Wiring with electrical tube and duct is recommended to keep out water and protect the wire from external damage. Also, be sure to use a waterproof gland at the conduit connection.
-

# MEMO

## Chapter 3 - Operating and Stopping of the Measuring System

---

### Outline of this chapter

This chapter explains the procedures for starting up this product and making zero adjustment. It also describes stopping the system.

When starting up and operating this product for the first time, carefully follow the explanation given in this chapter.

Zero adjustment is performed by using the data setting device.

Before using this product, be sure to perform the following settings as instructed in this chapter.

- Setting the write protect level
- Setting the empty detection function

## 3.1 Start-up

### Starting up

#### Procedures

Start up the electromagnetic flowmeter according to the following steps.

Step	Procedure
1	Make sure the electromagnetic flowmeter detector is properly installed on the pipe.
2	Make sure the wiring between the detector and converter has been completed properly.
3	Charge the converter with the fluid to be measured, and make the fluid stand still.
4	Make sure there is no fluid leaking from the flange to which the converter is attached.
5	Turn the power to the electromagnetic flowmeter ON.
6	Make a display similar to the one shown below appears on the LCD. <div data-bbox="833 1128 1251 1339" data-label="Image"><p>The image shows a rectangular LCD display with a black background and white text. At the top, it displays '0.0' in a large digital font, followed by a '%' symbol. Below this, it shows 'SPAN 0300.0 m3/h' and 'AL1 70%' on the left, and 'AL2 50%' on the right.</p></div>
	Start-up has now been completed.

## 3.2 Preparations before Measurement

---

### Zero Adjustment

---

#### Introduction

After start-up, be sure to zero the electromagnetic flowmeter. Zero adjustment is performed by using the data setting device.

---

# Method by Using the Data Setting Device

## Introduction





Adjust the electromagnetic flowmeter so that the instantaneous flow when the fluid in the detector stands still is measured as zero.

### Notes:

- Zero adjustment is very important for accurate flow rate measurement.

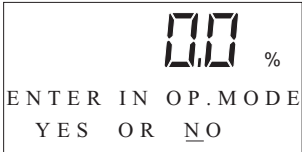
Be sure to zero the flowmeter before it is first operated.



- Before zero adjustment, make sure the detector is correctly Class 3 grounded and that the fluid to be measured has been charged and stands still in the detector. Zero adjustment becomes possible when the flow speed is 0.2 m/s or less, but wait until the fluid completely stops (Flow speed: 0.0 m/s) for accurate adjustment. Otherwise, output errors may result.

Step	Procedure	Screen
1	Touch the MODE key for more than 3 seconds. Note: The screen at left will be displayed for 8 seconds. Complete the following operations within 8 seconds.	
2	Touch the MODE key on the data setting device for more than three second to enter the Operator Mode. Touch the  key to display the screen shown. Note: This is the screen when the main display is set to % units.	
3	Touch the  key once.	

*(Continued on next page)*

## Method Using the Data Setting Device *(Continued)*

### Method using the data setting device

Step	Procedure	Screen
4	Touch the  key to start zero adjustment. During adjustment, when the large 7-segment displays the flow rate in %, "0.0" will be flashing. When zero adjustment is completed, the flashing will stop and the "ON" message will return to "READY". Zero adjustment takes about 30 seconds.	 <p>The screenshot shows a digital display with '0.0' and a '%' symbol. Below the display, the text '* AUTO ZERO' is visible, and 'ON' is displayed at the bottom of the screen.</p>
5	Lastly, be sure to end the operation by touching the MODE key.	

### 3.3 Stopping

---

 <b>Caution</b>
--

- |   |
|---|
| <ul style="list-style-type: none"><li>• Before stopping the flowmeter operation and shutting off the output to the control equipment, be sure to switch the control equipment to manual control. This will prevent the power shut-off on this unit from directly affecting the control equipment.</li></ul> |
|---|

---

#### Procedures

Perform the following steps to stop flowmeter operation.

Step	Procedure
1	Switch the control equipment connected to the flowmeter to the manual control mode.
2	Turn the power switch of the flowmeter OFF.

---



### 3.4 Setting Write Protection

**Introduction**

This product is set up at shipment so that settings can be made in any mode. However, write protection can be set to protect data from being accidentally changed after start-up.

**Levels of write protect**

The following write-protect levels are available. The product is set to level 0 when shipped.

Level	Operator's Mode	Engineering Mode	Maintenance Mode	Remarks
0	○	○	○	When shipped
1	○	○	×	
2	○	△	×	
3	△	△	×	





○: Both data confirmation and manipulation are possible.

△: Only data confirmation is possible.

×: Neither data confirmation nor manipulation is possible.

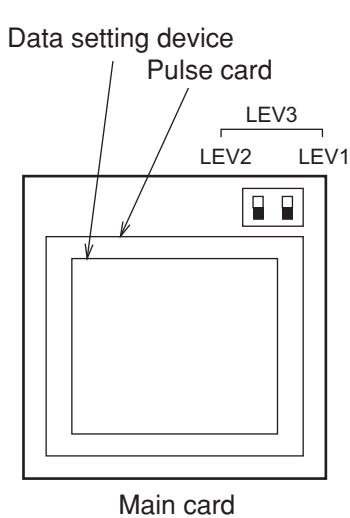
**Procedure 1**

To change the write-protect level, set the switches in the following steps.

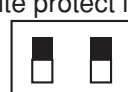
Step	Procedure
1	Remove the display cover.
2	<p>The switches are located on the main card. Set switches LEV1, LEV2, and LEV3 on the top of the card as shown below. (Move the switches to the blackened positions.)</p>  <p style="text-align: right;">           Write protect level 0              Write protect level 1              Write protect level 2              Write protect level 3   </p>

**MEMO**

## Chapter 4 - Operation Using the Data Setting Device

---

### Outline of this chapter

This chapter explains how to operate this product using the data setting device.

The device can be operated using the 4 keys on the data setting device.

---

# 4.1 Functions of the Data Setting Device

## Data Setting Device

### Names of parts

Figure 4-1 shows describes the parts of the data setting device.

Figure 4-1 Names of data setter parts

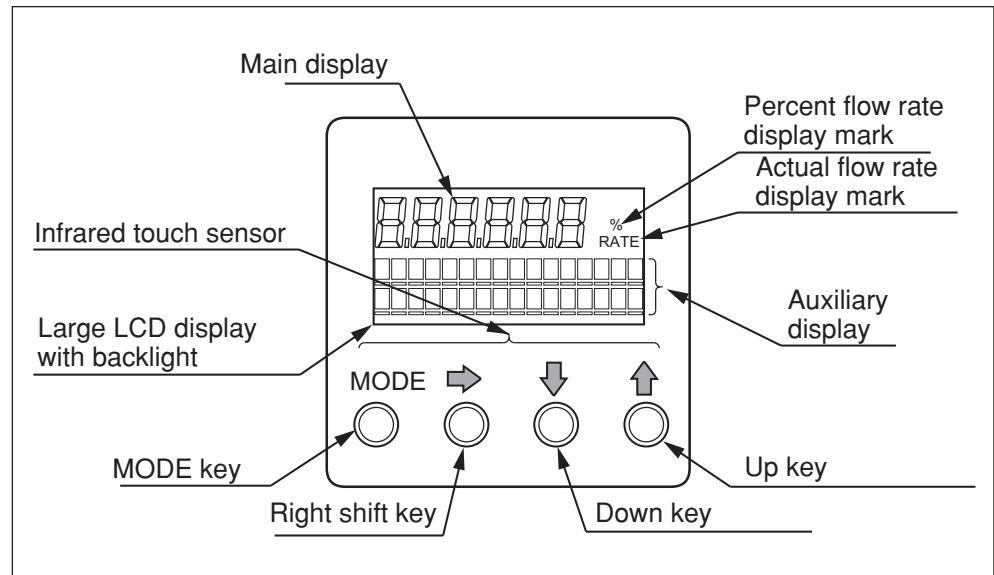

### Part names and explanation

The display that appears on the data setting device is explained below.

- Flow rate indication  
The display indicates “%” for percent flow rate, “RATE” for actual flow rate.

Section	Explanation
7-segment 6-digit display	<ul style="list-style-type: none"> <li>• Indicates the flow rate selected in the Operator’s Mode.</li> </ul>
Percent flow rate indicator (%)	<ul style="list-style-type: none"> <li>• Indicates that percent flow rate is currently displayed.</li> </ul>
Actual flow rate indicator (RATE)	<ul style="list-style-type: none"> <li>• Indicates that actual flow rate is currently displayed.</li> </ul>
Auxiliary display	<ul style="list-style-type: none"> <li>• During the Measuring Mode, indicates a flow rate to supplement the flow rate indication selected in the Operator’s Mode.</li> <li>• Indicates the procedures for parameter setting, adjustment, etc. when not in the Measuring Mode.</li> </ul>

(Continued on next page)



# Data Setting Device *(Continued)*

## Part names and explanation

The following is an explanation of the various keys on the data setting device.

- When operating the keys, be sure to close the cover. Only touch the keys through the glass.
- When operating the keys, touch the glass lightly, targeting the central part of each key.

Hold down the  or  key to scroll the characters up to 40 times.

Name	Explanation
<p>MODE key</p> <p>MODE</p> 	<ul style="list-style-type: none"> <li>• Enter the Operator's Mode.</li> <li>• After changing the parameters or internal data in the Engineering Mode or Maintenance Mode, press this key to write the data into memory.</li> <li>• Touch this key for more than one second to complete the write.</li> </ul>
<p>Right-shift key</p> 	<ul style="list-style-type: none"> <li>• Shift the cursor to the right.</li> </ul>
<p>Down key</p> 	<ul style="list-style-type: none"> <li>• Change the parameter at the cursor position.</li> <li>• Display the previous screen.</li> </ul> <p>When the cursor is located at the far left of the upper row (*, #, &gt;)</p> <div style="border: 1px solid black; padding: 5px; margin-bottom: 10px;"> <p>* OPERATOR'S MODE</p> <p>Cursor</p> </div> <p>Changes the screen.</p> <p>When the cursor is located at a numerical figure</p> <div style="border: 1px solid black; padding: 5px; margin-bottom: 10px;"> <p>* DAMPING      0 0 1 . 0 S</p> <p>Cursor</p> </div> <p>Decrements the numerical figure.</p> <p>When the cursor is located at the decimal point</p> <div style="border: 1px solid black; padding: 5px;"> <p>*                      1 . 0 0 0 m / s</p> <p>SPAN      0 7 . 0 6 9 m<sup>3</sup> / h</p> <p>Cursor</p> </div> <p>Moves the decimal point to the right.</p>

*(Continued on next page)*

# Data Setting Device *(Continued)*

**Part names and explanation**

Name	Explanation
<p>Up key</p> 	<ul style="list-style-type: none"> <li>• Change the parameter at the cursor position.</li> <li>• Display the next screen.</li> </ul> <p>When the cursor is located at the far left of the upper row (*, #, &gt;)</p> <div data-bbox="810 577 1238 712" style="border: 1px solid black; padding: 5px; margin-bottom: 10px;"> <p>* OPERATOR'S MODE</p> <p>Cursor</p> </div> <p>Changes the screen.</p> <p>When the cursor is located at a numerical figure</p> <div data-bbox="810 797 1238 931" style="border: 1px solid black; padding: 5px; margin-bottom: 10px;"> <p>* DAMPING 001.0 S</p> <p>Cursor</p> </div> <p>Increments the numerical figure.</p> <p>When the cursor is located at the decimal point</p> <div data-bbox="810 1016 1238 1151" style="border: 1px solid black; padding: 5px; margin-bottom: 10px;"> <p># SPAN 1.000 m/s 07.0690 m<sup>3</sup>/h</p> <p>Cursor</p> </div> <p>Moves the decimal point to the left.</p> <p>When the cursor is located at "READY"</p> <div data-bbox="810 1236 1238 1370" style="border: 1px solid black; padding: 5px;"> <p>* AUTO ZERO READY</p> <p>Cursor</p> </div> <p>Starts operation when touched.</p>

# Operating the Display/Data Setting Device

## Outline of the various modes

The following 4 modes are available on the device.

Mode	Explanation
MEASURING MODE	This mode indicates the measuring status.
OPERATOR'S MODE	<p>The operator setting mode is used for data that are registered or changed frequently. The settings can be changed at start-up and on other occasions when write protect is set to level 0, 1, or 2. With level 3, only configuration data monitoring is available. Includes damping time constant, auto zero adjustment, counter reset, counter preset value.</p> <p><b>Note:</b></p> <ul style="list-style-type: none"><li>Registered or changed data is temporarily written in to memory when input, but will return to the previous status within two minutes unless it is saved. (exception: only counter reset will not return to the previous status even after 2 minutes.)</li></ul> <p>To save the data, be sure to press the MODE key to open the Measuring Mode.</p> <p>When the mode changes to the Measuring Mode, the data will be written into memory.</p>

*(Continued on next page)*

# Operating the Display/Data Setting Device *(Continued)*

## Outline of the various modes

Mode	Explanation
ENGINEERING MODE	<p>This is the engineering setting mode. It is used for data that are registered or changed less frequently than in the Operator's Mode.</p> <p>Settings can be registered or changed when write protect is set to level 0 or 1. When the level is 2 or 3, only configuration data monitoring is available. Includes ID function setting, detector data, flow rate span, hysteresis width, output at error.</p> <p>Note:</p> <ul style="list-style-type: none"> <li>When registering or changing data, be sure to press the MODE key to write it to non-volatile memory. Rewriting occurs when the mode is changed to the Measuring mode by pressing the MODE key.</li> </ul>
MAINTENANCE MODE	<p>This is the maintenance setting mode. It is used when adjustment or verification is needed at regular maintenance periods or when an abnormality occurs. Settings can be adjusted or confirmed only when the write protect level is set at 0. Includes loop check, output adjustment, gain adjustment.</p> <p>This mode is further divided into the following 3 modes:</p> <ul style="list-style-type: none"> <li>OUTPUT CHECK MODE</li> <li>CALIBRATION MODE</li> <li>CRITICAL MODE</li> </ul> <p>Notes:</p> <ul style="list-style-type: none"> <li>Calibration Mode and Critical Mode contain adjustments and operations that are very important for flow rate measurement. When operating these modes, fully check the details of the adjustments to be made. Missetting will prevent measurement.</li> <li>When registering or changing data, be sure to press the MODE key to write it to non-volatile memory. Rewriting occurs when the mode is changed to the Measuring mode by pressing the MODE key.</li> </ul>



# Screen Organization

## Introduction

The device modes are arranged as follows.

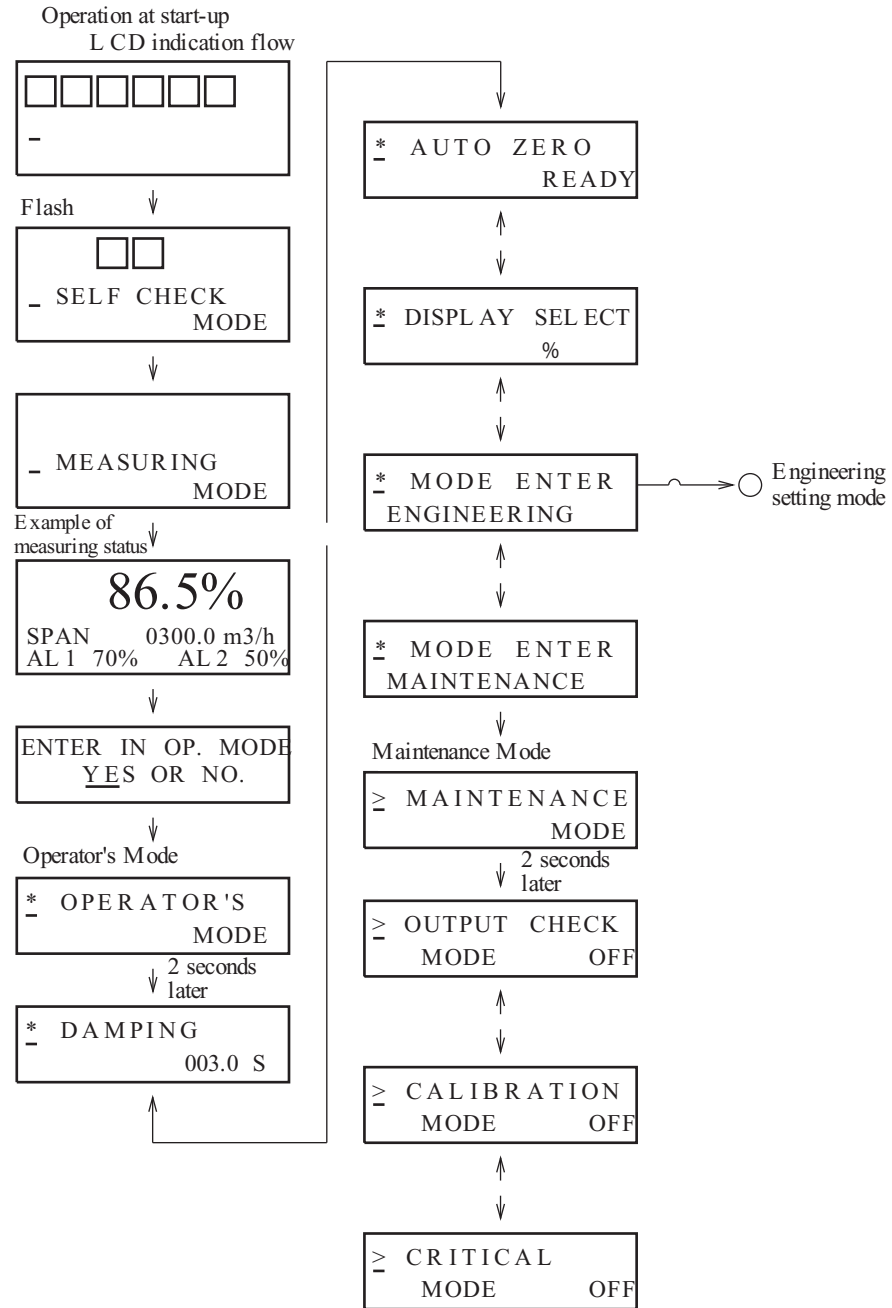

(Continued on next page)

# Screen Organization *(Continued)*

## Introduction

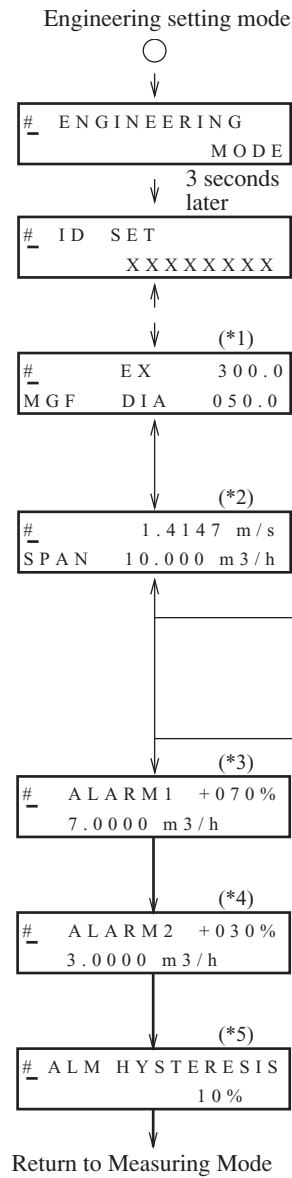

(\*1) The aperture ranges from 15 to 250 mm.

(\*2) This is displayed when the unit specification is weight.

(\*3) , (\*4) Make sure that the following condition is met:  $ALARM1 \geq ALARM2$ .

(\*5) A whole number within the range of 0 - 20% (in 1% units) can be selected as the hysteresis value. Make sure that the following condition is met:  $ALARM1 + HYS \leq 100\%$ .

# MEASURING MODE

## Introduction

The MEASURING MODE is an ordinary measurement mode. Screen displays in the normal state (the flow rate exceeds the alarm values) and the abnormal state (the flow rate is equal to or below the alarm values) are explained below.

## Normal state (% flow rate display)

Top line : Momentary % flow rate  
 Middle line : Span  
 Bottom line : Alarm value 1 (% display), Alarm value 2 (% display)  
 (Format) (Example)

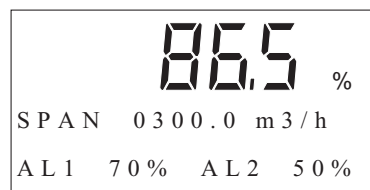
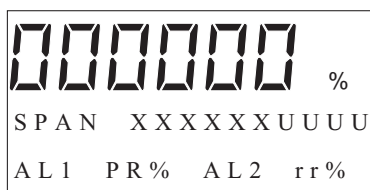

XXXXXX ... Actual flow rate span (6 digits)  
 UUUU ... Unit of actual flow rate span (4 digits)  
 RR ... % flow rate alarm value 1 (2-digit integer number within 0 - 99)  
 rr ... % flow rate alarm value 2 (2-digit integer number within 0 - 99)

## Normal state (Actual flow rate display)

Top line : Momentary actual flow rate  
 Middle line : Span  
 Bottom line : Alarm value 1 (% display), Alarm value 2 (% display)  
 (Format) (Example)

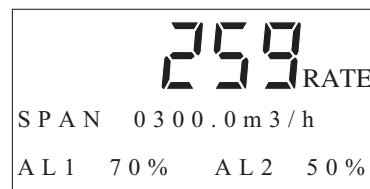
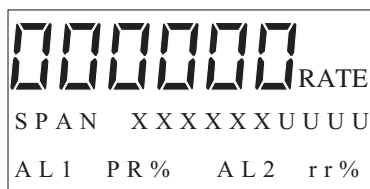

XXXXXX ... Actual flow rate span (6 digits)  
 UUUU ... Unit of actual flow rate span (4 digits)  
 RR ... % flow rate alarm value 1 (2-digit integer number within 0 - 99)  
 rr ... % flow rate alarm value 2 (2-digit integer number within 0 - 99)

## Abnormal state



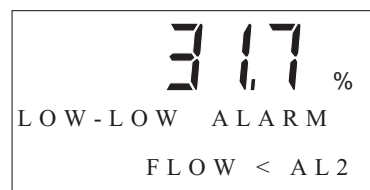
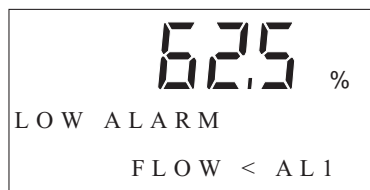



The display format is as follows when the measured data is below the alarm values. (Display in blinking mode)



Blinking alternately by 1-second cycles      Blinking alternately by 0.5-second cycles  
 (The screen shown on the left is not displayed when AL1 is equal to AL2.)



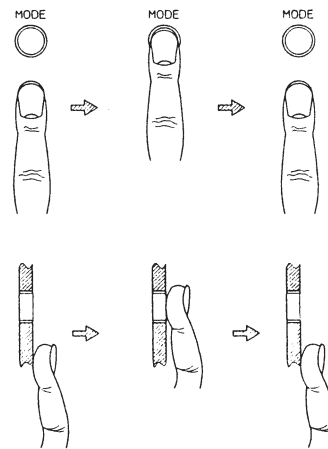

# How to Skillfully Operate the Touch Key Switches

---

1. As illustrated, move your finger upward from underneath the target, and completely cover the white round target.  
Then, move the finger downward to its original position.  
These motions ensure smooth key operation. If you move your finger sideways, you may inadvertently actuate the wrong key.
2. To enter the MODE key, keep touching the key for 3 seconds. Release the key on completion of screen change to ensure smooth operation. If the screen change is not completed within 3 seconds, move the finger off, and touch the MODE key again 3 seconds later. If you touch the key right away, the input may not be accepted.
3. To enter the , , or  keys in succession (increment or decrement), keep touching the target until the desired display is obtained. Note, however, that the  key stops at the mode signs shown below.  
\* (OPERATOR'S MODE)  
# (ENGINEERING MODE)  
> (MAINTENANCE MODE)  
To move the cursor again, press the  key again.  
The  and  keys can be incremented or decremented up to 40 times in succession. If you want to make another key entry, press the key again.



## How to Enter the Operator's Mode

Step	Procedure	Screen
1	The screen at right shows an example of display of 10 m <sup>3</sup> /h, 100% in the Measuring Mode. Touch the MODE key for about 3 seconds.	
2	<p>Complete the following operations within 8 seconds (the screen at right will be displayed for about 8 seconds only):</p> <p>1) To enter the Operator's Mode, move the cursor under "Y" by touching the ➡ key twice, and then touch the ⬆ key.</p> <p>2) To return to the Measuring Mode, move the cursor under "N" and touch the ⬆ key.</p> <p>The screen will automatically return to the Measuring Mode (screen shown in step 1) 8 seconds later.</p>	 
3	The operation mentioned under 1) in the above step will make the screen on the right be displayed for about 2 seconds.	
4	The Damping Setting screen will be displayed about 2 seconds later.	

# Operating in Operator's Mode

## Introduction

The Operator's Mode includes the following settings and adjustments. To enter the Operator's Mode, touch the MODE key for more than three seconds.

Screen display	Description	Indicated conditions
DAMPING	Sets the damping time constant	
AUTO ZERO	Performs zero adjustment	
DISPLAY SELECT	Sets the flow rate display	
MODE ENTER ENGINEERING	Enters the Engineering Mode	
MODE ENTER MAINTENANCE	Enters the Maintenance Mode	Setting of write protect to level 0.

Details of the screens are explained on the following pages using concrete examples. To display the various screens, enter the Operator's mode and then press the  key.

### Note:

- Settings and adjustments made in the Operator's Mode are temporarily written into memory when input. However, the settings will return to their previous status unless the data are saved within 2 minutes. Be sure to save the data by pressing the MODE key at the end of setting/adjustment.

# Resetting the Damping Time Constant

## Introduction

Set a damping time constant to cut out minute fluctuations when transmitting the measured instantaneous flow rate to the control equipment. Check the amplitude of variation in instantaneous flow output and set the damping time constant to an appropriate value.







The new value of the damping time constant becomes effective at the moment when the setting is changed.

## Default setting

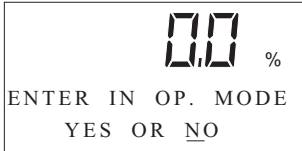
The damping time constant is set to 3 seconds at shipment.

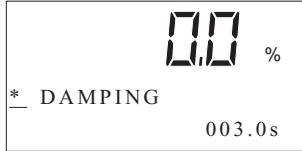
## Setting range

The time constant can be set to any value from 000.5 to 199.9.

Step	Procedure	Screen
1	Touch the MODE key for more than 3 seconds. Note: The screen at left will be displayed for 8 seconds. Complete the following operations within 8 seconds.	
2	Touch the MODE key for more than one second.	
3	About 2 seconds after that, the screen will indicate the damping time constant setup display.	
4	Touch the → key three times.	
5	Touch the ↑ or ↓ key to indicate the desired time constant. In this example, damping time is changed from 3 seconds to 10 seconds by six touches of the key ↑. The value can also be changed by holding down the key.	
6	Touch the → key twice.	







# Zero Adjustment

## Introduction

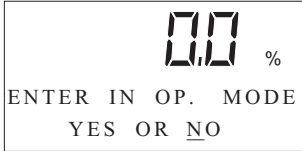
Adjust the flowmeter so that the measured instantaneous flow rate will be zero when the fluid stands still in the detector.

### Notes:

- Zero adjustment is very important for accurate flow measurement. Before operating the unit for the first time, be sure to zero the flowmeter.
- Before zero adjustment, make sure the detector has proper Class 3 grounding and that the fluid to be measured is charged into the detector and is standing still. Zero adjustment is possible when the flow speed is 0.2 m/s or below, but wait until the fluid completely stops (flow speed: 0.0 m/s) for accurate adjustment. Otherwise, output errors may result.



Step	Procedure	Screen
1	Touch the MODE key for more than 3 seconds. Note: The screen at left will be displayed for 8 seconds. Complete the following operations within 8 seconds.	
2	Touch the MODE key for more than one second.	
3	Touch the MODE key on the data setting device for more than one second to enter the Operator's Mode. Touch the  key to open the screen shown at right. Note: The figure shows the screen when the main display is set at %.	
4	Touch the  key once.	

(Continued on next page)

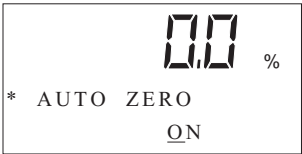

# Zero Adjustment *(Continued)*

## Zero Adjustment

Step	Procedure	Screen
5	Touch the  key to start zero adjustment. When the large 7-segment display shows the flow rate in percent, “0.0” will flash during adjustment. When zero adjustment is completed, the flashing will stop and the “ON” message will return to “READY.” It takes about 30 seconds for zero adjustment.	
6	Touch the  key once.	

# Setting/Changing the Flow Rate Indication

**Introduction** Selects the mode of flow rate indication for the main display: from percent display: actual flow rate display.

**Default setting** The default setting is percent display.

**Setting range** Select either “%” (instantaneous percent flow rate), “RATE” (instantaneous actual flow rate).

Step	Procedure	Screen
1	Open the flow rate display setup screen by following the steps to enter the Operator’s Mode.	<p>The screen shows a digital display of '0.0' followed by a percent sign. Below the display, there are two menu options: '* DISPLAY SELECT' and '%'. A horizontal line is positioned below the first option.</p>
2	Touch the → key once.	<p>The screen is identical to the previous one, showing '0.0 %' and the menu options '* DISPLAY SELECT' and '%'. A horizontal line is positioned below the first option.</p>
3	Touch the ↑ or ↓ key to select the desired flow rate display. In this example, “%” is changed to “RATE” by one touch of the ↑ key.	<p>The screen shows a digital display of '0.000' followed by the word 'RATE'. Below the display, there are two menu options: '* DISPLAY SELECT' and 'RATE'. A horizontal line is positioned below the second option.</p>
4	Touch the → key once.	<p>The screen is identical to the previous one, showing '0.000 RATE' and the menu options '* DISPLAY SELECT' and 'RATE'. A horizontal line is positioned below the second option.</p>

# Selecting Modes



## Introduction

Select either the Engineering Mode (to operate the setting parameters of the electromagnetic flowmeter) or the Maintenance Mode (to perform adjustments or inspection).

**Note:**

- In some cases, a mode selection screen will not open, depending on the write-protect setting. Only the Engineering Mode selection screen will open if the write-protect switches on the main board are used to select level 1, 2, or 3. If level 0 is selected, both the Engineering Mode and the Maintenance Mode will open. Refer to Chapters 3 and 5.

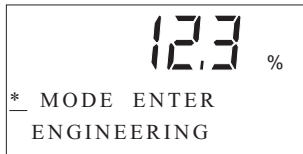
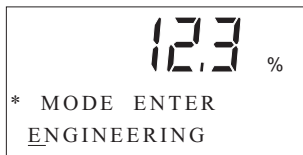
To enter the Engineering Mode







Step	Procedure	Screen
1	Call up the Engineering Mode selection screen by following the steps to enter the Operator's Mode.	
2	Touch the → key once.	
3	Touch the ↑ key, and the display will change to the Engineering Mode.	
4	Two seconds later, the display shown at right will appear.	

*(Continued on next page)*

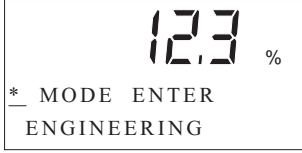
# Selecting Modes

## Introduction

To enter the Maintenance Mode

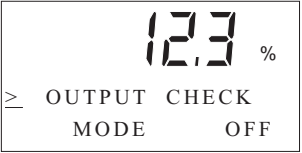
Step	Procedure	Screen
1	Call up the Maintenance Mode selection screen by following the steps to enter the Operator's Mode.	 <p>12.3 % * MODE ENTER ENGINEERING</p>
2	Touch the  key once.	 <p>12.3 % * MODE ENTER ENGINEERING</p>
3	Touch the  key once.	 <p>12.3 % * MODE ENTER <u>ENGINEERING</u></p>
4	Touch the  key, and the display will change to the Maintenance Mode.	 <p>12.3 % ≥ MAINTENANCE MODE</p>
5	Two seconds later, the display shown at right will appear.	 <p>12.3 % ≥ OUTPUT CHECK MODE OFF</p>

# Engineering Mode

## Introduction

The Engineering Mode contains the following settings and adjustments.

Screen display	Description	Indicated conditions
ID SET	Sets the ID	
EX, MGF, DIA	Sets detector data	
SPAN	Sets the range	
GRAVITY	Selects the specific gravity	Selection of a weight unit (t, kg, g, lb) in range setting.
ALARM1	Set alarm contact 1.	
ALARM2	Set alarm contact 2.	
ALM HYSTERESIS	Set hysteresis for the alarm contacts.	

Details of the various screens are explained on the following pages. To open the various screens, press the  key after entering Engineering Mode.

### Note:









- To write data set in the Engineering Mode to non-volatile memory, press the MODE key. When changing data, be sure to press the MODE key.

# Setting the ID

**Introduction** Sets the ID code for the electromagnetic flowmeter.

**Default setting** XXXXXXXX

**Setting range** The ID code can be set using up to 8 alphanumeric characters: letters (A to Z), numbers to 9), -, /, space, and period.

Step	Procedure	Screen
1	Open the ID setup display by following the steps to enter the Engineering Mode.	 <p># ID SET XXXXXXX</p>
2	Touch the  key to move the cursor to the characters to be changed.	 <p># ID SET X XXXXXXX</p>
3	Touch the  or  key to change the characters to the desired ones. Use the Right-shift, Down, and Up keys to set up the desired code.	 <p># ID SET F XXXXXXX</p>
4	When the desired tag No. is shown, touch the  key to move the cursor to the “*”.	 <p># ID SET FIC-0001</p>

# Detector Data Setup

## Introduction











This is used to set and select the constant, and diameter of the detector to be used in combination with the converter.

## Default setting

EX300.0, MGF, DIA 050.0 will be selected.

### Note:

- When you purchase the converter and detector in combination, your converter will contain the detector data that was set during actual flow calibration. Take care not to change the data, or the flowmeter output will be incorrect. Refer to Table 4-1.

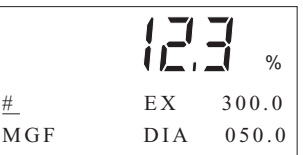
Step	Procedure	Screen
1	Open the detector data setup screen by following the steps to enter the Engineering Mode.	 <p># EX 300.0 MGF DIA 050.0</p>
2	Touch the  key to set the detector constant. Use the  and  keys to input the numerical value printed on the EX column of the detector nameplate.	 <p># EX 320.0 MGF DIA 050.0</p>
3	Touch the  key to select the diameter. Use the  and  keys to select the diameter of the detector to be used.	 <p># EX 300.0 MGF DIA 050.0</p>
4	Use the  key to move the cursor to the "#".	 <p># EX 300.0 MGF DIA 050.0</p>

(Continued on next page)

## Detector Data Setup *(Continued)*

---

### Default setting

Table 4-1 Convertor-sensor combinations

○: Allowable setting

Aperture/Sensor Model No.	MGF
15.0	○
25.0	○
40.0	○
50.0	○
65.0	○
80.0	○
100.0	○
125.0	○
150.0	○
200.0	○
250.0	○

Remarks:

- The exciting current value (EX value) setting method varies according to sensor model numbers. Wrong setting can cause errors and equipment destruction.
-



# Setting the Range

## Introduction

This is used to set the flow rate measurement range, which means the value when the electromagnetic output reaches 100%. The lower limit of the range is zero.

## Setting the range

Flow rate: 0.0001 - 99999  
 Units: m<sup>3</sup>, l, cm<sup>3</sup>, t, kg, g  
 Time units: s, min., h, d

When single range is selected

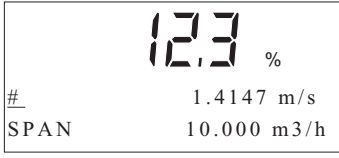
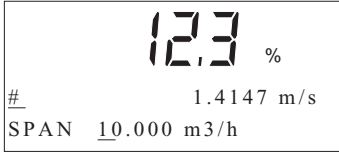
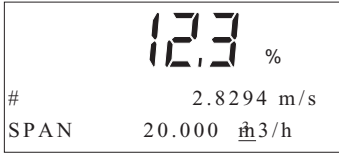
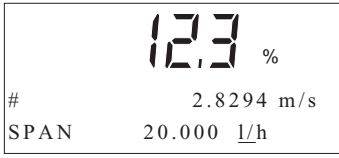
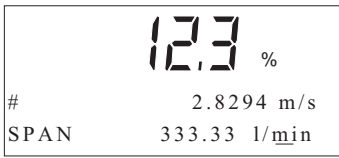
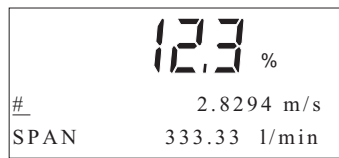







Step	Procedure	Screen
1	Open the range setup screen by following the steps to enter the Engineering Mode.	
2	Touch the → key to move the cursor to the desired digits.	
3	Use the ↑ and ↓ keys to change the numbers.	
4	Touch the → key to move the cursor to the time unit. Use the ↑ or ↓ key to select the desired unit.	
5	Touch the → key to move the cursor to the flow rate unit. Use the ↑ or ↓ key to select the desired unit.	
6	Touch the → key to move the cursor to the "#".	

## Setting the Specific Gravity

**Introduction** This is used to set the specific gravity when selecting a weight unit (t, kg, g) in range setting. Without this setting, an output error may result.

**Default setting** 1.0000

**Setting range** 0.1000 - 9.9999







Step	Procedure	Screen
1	Open the specific gravity setup screen by following the steps to enter the Engineering Mode.	 <p>12.3 % # GRAVITY 1.0000</p>
2	Use the  key to move the cursor to the desired numbers.	 <p>12.3 % # GRAVITY 1.00<u>0</u>0</p>
3	Use the  and  keys to change the figures.	 <p>12.3 % # GRAVITY 1.00<u>5</u>0</p>
4	Touch the  key to move the cursor to the "#".	 <p>12.3 % # GRAVITY 1.0050</p>

# Setting alarm contact 1

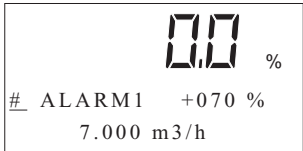
**Introduction** An alarm is output when the momentary % flow rate value becomes equal to or smaller than the setting.

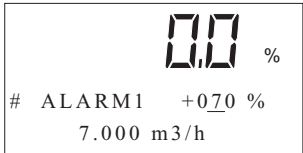
**Initial setting** 70%

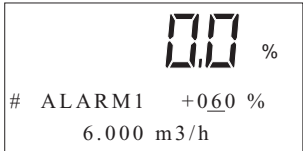
**Valid setting range** 0 - 99%

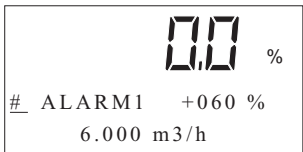
Step	Procedure	Screen
1	Display the alarm contact 1 setting screen according to the procedure used for selecting the ENGINEERING MODE.	
2	Using the  key, move the cursor to the bottom of the digit you want to change.	
3	Using the  or  key, set a new value.	
4	Touch the  key to move the cursor to the bottom of #.	

Make sure that the following condition is met:  $ALARM1 \geq ALARM2$ .

## Setting alarm contact 2

**Introduction** An alarm is output when the momentary % flow rate value becomes equal to or smaller than the setting.

**Initial setting** 30%

**Valid setting range** 0 - 99%

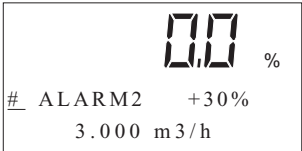
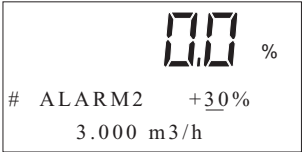
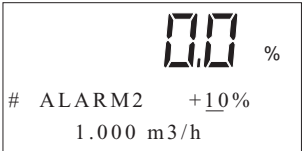
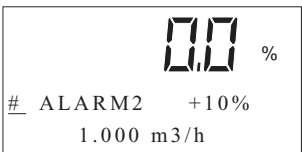
Step	Procedure	Screen
1	Display the alarm contact 2 setting screen according to the procedure used for selecting the ENGINEERING MODE.	
2	Using the → key, move the cursor to the bottom of the digit you want to change.	
3	Using the ↓ or ↑ key, set a new value.	
4	Touch the → key to move the cursor to the bottom of #.	





Make sure that the following condition is met:  $ALARM1 \geq ALARM2$ .

# Setting alarm hysteresis

**Introduction** Set a hysteresis value for the alarm contacts.

**Initial setting** 10%

**Valid setting range** 0 - 20% (in 1% units). Make sure that the following condition is met:  $ALARM1 + HYS \leq 100\%$ .

Step	Procedure	Screen
1	Display the hysteresis setting screen according to the procedure used for selecting the ENGINEERING MODE.	
2	Touch the → key once.	
3	Using the ↓ or ↑ key, input hysteresis value. In this example, 10% was changed to 5%.	
4	Touch the → key to move the cursor to the bottom of #.	

# Maintenance Mode

## Introduction

The Maintenance Mode includes the following adjustments and items to be checked. Refer to Chapter 6 for the operating method.

## OUTPUT CHECK MODE

Screen display	Description
ALARM1 CLOSE ALARM2 CLOSE	Check the alarm contact output loop.
EX CHECK	Check the excitation source.

## CALIBRATION MODE

Screen display	Description
CAL EX	Adjusts the excitation current
CAL GAIN	Adjusts the converter gain

## CRITICAL MODE

Screen display	Description
ROM VER.	Checks the ROM version
ERROR HISTORY	Checks the error history
SHIPPING DATA RECOVERY	Restores the internal data to the status at shipment
INITIAL DATA RECOVERY	Initializes the internal data

## Chapter 5 - Maintenance and Troubleshooting of the Electromagnetic Flowmeter

---

### Outline of this chapter

This chapter describes the maintenance and inspection procedures for the electromagnetic flowmeter and the information that should be referred to during troubleshooting.

First, this chapter explains the procedures used to check the converter functions. The items to be checked are as follows.

- Input/output signal loop check
  - Contact output
  - Excitation current
- False signal input by the calibrator

These items serve to aid in early detection of the causes of abnormalities in converter operation.

This chapter also explains the troubleshooting procedures and the initial data recovery procedures.

---





## 5.1 Function check

### Checking alarm contact output

**Introduction** Alarm contact output can be checked using an electromagnetic flow switch.

**Initial setting** CLOSE

**Valid setting range** CLOSE or OPEN

Step	Procedure	Screen
1	Display the alarm contact output checking screen according to the procedure used for selecting the MAINTENANCE MODE.	
2	Touch the → key to move the cursor to the bottom of the alarm contact you want to check.	
3	Using the ↑ or ↓ key, change to the status you want to check. In the screen on the right, OPEN is output for alarm contact 1.	
4	Touch the → key to move the cursor to the bottom >. The display will return to the analogue output based on the % and actual flow rate in the main display.	
5	When the screen is changed to another screen using the ↑ or ↓ key, the display returns to analogue output based on actual flow rate.	











# Checking the Excitation Current

## Introduction

It is possible to check the excitation current value that flows into the coil in the detector and its flow direction.

This check is not possible for integral models.

Step	Procedure	Screen
1	Open the excitation current check screen by following the steps to enter the Maintenance Mode. In this situation, the multimeter output will not be stable since the excitation current is flowing rectangularly.	 <p>12.3 %            ≥ EX CHECK            EXX 160.0</p>
2	Touch the  key once, and the excitation current will be a direct current and will flow from X to Y. Make sure the current reaches 160.0 mA.	 <p>12.3 %            &gt; EX CHECK            EXX 160.0</p>
3	Touch the  key again, and the current will flow from Y to X. The polarity will be the reverse of the status in Step 2.	 <p>12.3 %            &gt; EX CHECK            EXY 160.0</p>
4	Touch the  key again, and the excitation current will stop.	 <p>12.3 %            &gt; EX CHECK            OFF 160.0</p>
5	Finally, touch the  key again to move the cursor to “>”.	 <p>12.3 %            ≥ EX CHECK            OFF 160.0</p>

# False Signal Input by Calibrator

---

**Introduction** The electromagnetic flowmeter is provided with a dedicated calibrator, which has the function of generating the same signal as the flow rate signal from the detector. The converter function can be checked using this false signal.

---

**When to use** When a problem occurs in the converter, use this method to judge whether detector or the converter is responsible for the problem.

---

**Preparation** Prepare the following equipment.

- Dedicated calibrator and dedicated cable
- Digital voltmeter
- Resistor (250Ω)

In addition, the value of the measuring span is needed as data to be input into the dedicated calibrator.

---

**How to check** Calibrate the electromagnetic flowmeter according to the calibrator's operating manual. The code of the calibrator's operating manual is CM2-MGZ100-2001.

---

## 5-2 Troubleshooting

---

### Overview

---

#### Introduction

If a problem occurs at electromagnetic flowmeter start-up and operation, the following three causes should be considered.

- Inconsistency between the electromagnetic flowmeter's specifications and the actual operating conditions

- Missetting or misoperation

- Electromagnetic flowmeter malfunction

If a problem occurs during electromagnetic operation, the converter's self-diagnostic function will classify it as serious or minor. It will indicate this and respond accordingly.

Perform the proper correction measures, referring to the troubleshooting guidelines described in this section.

---

#### Serious trouble

Serious problems may obstruct electromagnetic flowmeter operation and finally damage the flowmeter, if not corrected. When serious trouble occurs during electromagnetic flowmeter operation, an error message will appear on the converter's display panel and the flowmeter will continue to output the preset value in the abnormality treatment (fail-safe) direction. The error message and the self-diagnostic results will be visible on the display panel.

Example:

- EX CHECK ERROR: This message appears if the detector coil has been disconnected.

---

#### Minor trouble

Minor problems will not seriously obstruct electromagnetic flowmeter operation. When an error occurs during electromagnetic flowmeter operation and is regarded as a minor problem by the converter self-diagnostics, the output will not burn out and the electromagnetic flowmeter will continue to output the instantaneous flow rate.

---

## Errors at Start-up

### Troubleshooting

When a problem occurs at start-up, perform the following procedures. If the problem remains, it is possible that the electromagnetic flowmeter has been damaged. Contact the reference listed on the last page of this manual.

Trouble	Check points and treatment
No indication on display panel at power-up.	<ul style="list-style-type: none"><li>• Check the converter power supply specification.</li><li>• Make sure the ambient temperature is not below <math>-25^{\circ}\text{C}</math>.</li></ul>
No output at power-up.	<ul style="list-style-type: none"><li>• Make sure the signal line is correctly connected.</li></ul>

# Errors during Operation

## Troubleshooting

When a problem occurs during operation, perform the following procedures.

1. Check against the table on this page for symptoms of the error. If found, perform the steps indicated in the table.
2. When the problem cannot be solved, it is possible that the electromagnetic flowmeter has been damaged. Contact the reference listed on the last page of this manual.

Trouble	Check points and treatment
Output fluctuates excessively beyond the estimated flow rate range.	<ul style="list-style-type: none"> <li>• Make sure the electromagnetic flowmeter is correctly grounded.</li> <li>• Make sure the damping time constant is set correctly.</li> <li>• Clean the electrodes.</li> </ul>
Output exceeds 100%.	<ul style="list-style-type: none"> <li>• Make sure the set range is set correctly.</li> <li>• Make sure the span is set correctly.</li> <li>• Make sure the zero point is correctly adjusted.</li> </ul>
Output remains 0%.	<ul style="list-style-type: none"> <li>• Make sure the pipe is not empty.</li> <li>• Make sure the signal line is correctly connected.</li> <li>• Make sure the valves are open on the upper and lower sides.</li> <li>• Make sure the span is set correctly.</li> </ul>
Output has burnt out.	<ul style="list-style-type: none"> <li>• Refer to “Error messages and treatment” to perform measures.</li> </ul>

# Error Messages and Treatment (Display)

**Hardware check**

Hardware check is executed in the Measuring Mode.  
 Perform the proper measures immediately.  
 While an error code (Err-01 to Err-05) is being displayed, the output for the abnormal situation will be as preset in the Engineering Mode.

**Error codes for serious trouble**

**Err - 01**  
 EX CHECK  
 ERROR

Error code	Error contents	Treatment	LCD display
Err-01	Coil disconnected EX open	1. Check connection. 2. Measure coil resistance. 3. Restore power.	EX CHECK ERROR
Err-02	ROM check error	1. Restore power. 2. Replace ROM. 3. Replace main circuit board.	ROM CHECK ERROR
Err-03	RAM READ AFTER WRITE error	1. Restore power. 2. Replace main circuit board.	RAM CHECK ERROR
Err-04	NVM READ AFTER WRITE error	1. Restore power. 2. Replace main circuit board.	NVM CHECK ERROR
Err-05	ADC error A/D change error	1. Restore power. 2. Replace main circuit board.	ADC CHECK ERROR

*(Continued on next page)*

## Error Messages and Treatment (Display) *(Continued)*

### Checking for mis-setting

Missetting diagnostics are executed in the Engineering Mode. When a setting is incorrect, the error will be displayed for one second and then the incorrectly-set screen will appear. (To view the error contents again, press the MODE key.)

Note: Press the MODE key for more than 5 seconds, and the data will return to the status obtaining before entering the Engineering Mode.

### Error codes for minor trouble

Error code	Error contents	Treatment	LCD display
Err-13	ALARM1 is smaller than ALARM2.	Change the setting to $ALARM1 \geq ALARM2$ .	SETTING ERROR ALM < ALM2
Err-21	Span setting of 12 m/s or more.	Check SPAN, DIA, TYPE, DUMMY settings.	SPAN ERROR OVER 12m/s

# Terms and Conditions

We would like to express our appreciation for your purchase and use of Azbil Corporation's products.

You are required to acknowledge and agree upon the following terms and conditions for your purchase of Azbil Corporation's products (system products, field instruments, control valves, and control products), unless otherwise stated in any separate document, including, without limitation, estimation sheets, written agreements, catalogs, specifications and instruction manuals.

## 1. Warranty period and warranty scope

### 1.1 Warranty period

Azbil Corporation's products shall be warranted for one (1) year from the date of your purchase of the said products or the delivery of the said products to a place designated by you.

### 1.2 Warranty scope

In the event that Azbil Corporation's product has any failure attributable to azbil during the aforementioned warranty period, Azbil Corporation shall, without charge, deliver a replacement for the said product to the place where you purchased, or repair the said product and deliver it to the aforementioned place. Notwithstanding the foregoing, any failure falling under one of the following shall not be covered under this warranty:

- (1) Failure caused by your improper use of azbil product (noncompliance with conditions, environment of use, precautions, etc. set forth in catalogs, specifications, instruction manuals, etc.);
- (2) Failure caused for other reasons than Azbil Corporation's product;
- (3) Failure caused by any modification or repair made by any person other than Azbil Corporation or Azbil Corporation's subcontractors;
- (4) Failure caused by your use of Azbil Corporation's product in a manner not conforming to the intended usage of that product;
- (5) Failure that the state-of-the-art at the time of Azbil Corporation's shipment did not allow Azbil Corporation to predict; or
- (6) Failure that arose from any reason not attributable to Azbil Corporation, including, without limitation, acts of God, disasters, and actions taken by a third party.

Please note that the term "warranty" as used herein refers to equipment-only-warranty, and Azbil Corporation shall not be liable for any damages, including direct, indirect, special, incidental or consequential damages in connection with or arising out of Azbil Corporation's products.

## 2. Ascertainment of suitability

You are required to ascertain the suitability of Azbil Corporation's product in case of your use of the same with your machinery, equipment, etc. (hereinafter referred to as "Equipment") on your own responsibility, taking the following matters into consideration:

- (1) Regulations and standards or laws that your Equipment is to comply with.
- (2) Examples of application described in any documents provided by Azbil Corporation are for your reference purpose only, and you are required to check the functions and safety of your Equipment prior to your use.
- (3) Measures to be taken to secure the required level of the reliability and safety of your Equipment in your use

Although azbil is constantly making efforts to improve the quality and reliability of Azbil Corporation's products, there exists a possibility that parts and machinery may break down. You are required to provide your Equipment with safety design such as fool-proof design,\*1 and fail-safe design\*2 (anti-flame propagation design, etc.), whereby preventing any occurrence of physical injuries, fires, significant damage, and so forth. Furthermore, fault avoidance,\*3 fault tolerance,\*4 or the like should be incorporated so that the said Equipment can satisfy the level of reliability and safety required for your use.

\*1. A design that is safe even if the user makes an error.

\*2. A design that is safe even if the device fails.

\*3. Avoidance of device failure by using highly reliable components, etc.

\*4. The use of redundancy.

## 3. Precautions and restrictions on application

### 3.1 Restrictions on application

Please follow the table below for use in nuclear power or radiation-related equipment.

	Nuclear power quality*5 required	Nuclear power quality*5 not required
Within a radiation controlled area*6	Cannot be used (except for limit switches for nuclear power*7)	Cannot be used (except for limit switches for nuclear power*7)
Outside a radiation controlled area*6	Cannot be used (except for limit switches for nuclear power*7)	Can be used

\*5. Nuclear power quality: compliance with JEAG 4121 required

\*6. Radiation controlled area: an area governed by the requirements of article 3 of "Rules on the Prevention of Harm from Ionizing Radiation," article 2 2 4 of "Regulations on Installation and Operation of Nuclear Reactors for Practical Power Generation," article 4 of "Determining the Quantity, etc., of Radiation-Emitting Isotopes," etc.

\*7. Limit switch for nuclear power: a limit switch designed, manufactured and sold according to IEEE 382 and JEAG 4121.

Any Azbil Corporation's products shall not be used for/with medical equipment.

The products are for industrial use. Do not allow general consumers to install or use any Azbil Corporation's product. However, azbil products can be incorporated into products used by general consumers. If you intend to use a product for that purpose, please contact one of our sales representatives.

### 3.2 Precautions on application

you are required to conduct a consultation with our sales representative and understand detail specifications, cautions for operation, and so forth by reference to catalogs, specifications, instruction manual, etc. in case that you intend to use azbil product for any purposes specified in (1) through (6) below. Moreover, you are required to provide your Equipment with fool-proof design, fail-safe design, anti-flame propagation design, fault avoidance, fault tolerance, and other kinds of protection/safety circuit design on your own responsibility to ensure reliability and safety, whereby preventing problems caused by failure or nonconformity.



- (1) For use under such conditions or in such environments as not stated in technical documents, including catalogs, specification, and instruction manuals
- (2) For use of specific purposes, such as:
  - \* Nuclear energy/radiation related facilities  
[When used outside a radiation controlled area and where nuclear power quality is not required]  
[When the limit switch for nuclear power is used]
  - \* Machinery or equipment for space/sea bottom
  - \* Transportation equipment  
[Railway, aircraft, vessels, vehicle equipment, etc.]
  - \* Antidisaster/crime-prevention equipment
  - \* Burning appliances
  - \* Electrothermal equipment
  - \* Amusement facilities
  - \* Facilities/applications associated directly with billing
- (3) Supply systems such as electricity/gas/water supply systems, large-scale communication systems, and traffic/air traffic control systems requiring high reliability
- (4) Facilities that are to comply with regulations of governmental/public agencies or specific industries
- (5) Machinery or equipment that may affect human lives, human bodies or properties
- (6) Other machinery or equipment equivalent to those set forth in items (1) to (5) above which require high reliability and safety

#### 4. Precautions against long-term use

Use of Azbil Corporation's products, including switches, which contain electronic components, over a prolonged period may degrade insulation or increase contact-resistance and may result in heat generation or any other similar problem causing such product or switch to develop safety hazards such as smoking, ignition, and electrification. Although acceleration of the above situation varies depending on the conditions or environment of use of the products, you are required not to use any Azbil Corporation's products for a period exceeding ten (10) years unless otherwise stated in specifications or instruction manuals.

#### 5. Recommendation for renewal

Mechanical components, such as relays and switches, used for Azbil Corporation's products will reach the end of their life due to wear by repetitious open/close operations.

In addition, electronic components such as electrolytic capacitors will reach the end of their life due to aged deterioration based on the conditions or environment in which such electronic components are used. Although acceleration of the above situation varies depending on the conditions or environment of use, the number of open/close operations of relays, etc. as prescribed in specifications or instruction manuals, or depending on the design margin of your machine or equipment, you are required to renew any Azbil Corporation's products every 5 to 10 years unless otherwise specified in specifications or instruction manuals. System products, field instruments (sensors such as pressure/flow/level sensors, regulating valves, etc.) will reach the end of their life due to aged deterioration of parts. For those parts that will reach the end of their life due to aged deterioration, recommended replacement cycles are prescribed. You are required to replace parts based on such recommended replacement cycles.

#### 6. Other precautions

Prior to your use of Azbil Corporation's products, you are required to understand and comply with specifications (e.g., conditions and environment of use), precautions, warnings/cautions/notices as set forth in the technical documents prepared for individual Azbil Corporation's products, such as catalogs, specifications, and instruction manuals to ensure the quality, reliability, and safety of those products.

#### 7. Changes to specifications

Please note that the descriptions contained in any documents provided by azbil are subject to change without notice for improvement or for any other reason. For inquires or information on specifications as you may need to check, please contact our branch offices or sales offices, or your local sales agents.

#### 8. Discontinuance of the supply of products/parts

Please note that the production of any Azbil Corporation's product may be discontinued without notice. After manufacturing is discontinued, we may not be able to provide replacement products even within the warranty period.

For repairable products, we will, in principle, undertake repairs for five (5) years after the discontinuance of those products. In some cases, however, we cannot undertake such repairs for reasons, such as the absence of repair parts. For system products, field instruments, we may not be able to undertake parts replacement for similar reasons.

#### 9. Scope of services

Prices of Azbil Corporation's products do not include any charges for services such as engineer dispatch service. Accordingly, a separate fee will be charged in any of the following cases:

- (1) Installation, adjustment, guidance, and attendance at a test run
- (2) Maintenance, inspection, adjustment, and repair
- (3) Technical guidance and technical education
- (4) Special test or special inspection of a product under the conditions specified by you

Please note that we cannot provide any services as set forth above in a nuclear energy controlled area (radiation controlled area) or at a place where the level of exposure to radiation is equivalent to that in a nuclear energy controlled area.



---

**Document Number :** CM2-MGF100-2001  
**Document Name :** MagneW 3000 FLEX Electromagnetic  
Flow Switch  
(Integral Type, Remote Type Converter)  
Model MGF

---

**Date :** May 2024 Rev.4  
**Issued / Edited by :** Azbil Corporation

---

Azbil Corporation