

MagneW 3000 FLEX
Electromagnetic Flow Switch
Integral Type,
Remote Type Converter
Model MGF
User's Manual



Azbil Corporation

Copyright, Notices and Trademarks

Printed in Japan - © Copyright 2014 by Azbil Corporation

While this information is presented in good faith and believed to be accurate, Azbil Corporation disclaims the implied warranties of merchantability and fitness for a particular purpose and makes no express warranties except as may be stated in its written agreement with and for its customer.

In no event is Azbil Corporation liable to anyone for any indirect, special or consequential damages, The information and specifications in this document are subject to change without notice.

MagneW3000 is a trademark of Azbil Corporation.

Preface

Thank you for purchasing Azbil Corporation MagneW 3000 FLEX Electromagnetic Flow Switch. Model MGF electromagnetic flow switches, fruit of our long experience and outstanding performance, are designed for uses for cooling water, generator coolers, and hydraulic turbine sealing water. They are multifunction convertors characterized by a wide range of applications and easy field operations.

Unpacking and Inspecting Your Product

Unpacking the product

This device is a precision instrument and should be handled with care to prevent damage or breakage.

After unpacking the device, verify that the following items are included:

- Flow Switch itself
 - Standard accessories
 - MagneW Setting Data Sheet
 - Test report
-

Verifying the specifications

The specifications of this device are written on its attached identification plate. Compare these specifications with those listed in the Appendix, "System Standard Specifications and Model Numbers," and verify that all specifications on the plate are correct, paying special attention to the following:

- Basic model number
 - Power supply
-

Inquiries

If you have any questions regarding the specifications of this device, contact your nearest Azbil Corporation office or Azbil Corporation representative. When making an inquiry, make sure to provide the model number and product number of this device.

Storage precautions

When storing this device before use, observe these precautions:

- Store it indoors at room temperature and humidity, in a place safe from vibration or shock.
- Store it in the same condition as it was shipped.

When storing this device after use, follow these steps:

1. Attach the display cover, the terminal box cover, and the water-proof gland to keep out moisture.
 2. Replace the product in its original packaging.
 3. Store it indoors at normal temperature and humidity and in a place safe from vibration or shock.
-

Safety Precautions

Introduction

Correct installation, correct operation and regular maintenance are essential to ensure safety when using this device. Don't use the system, before reading and understanding the safety precautions described in this manual and be sure to follow the instructions on installation, operation and maintenance.

Signal words

Two kinds of safety precaution are used in this manual —Warning and Caution. The meaning of these is as follows:



Warning

Potentially hazardous situation which, if not avoided, could result in death or serious injury.



Caution

Failure to observe these precautions may produce dangerous conditions that could result in injury to the user or in physical damage.

How this Manual is Organized and Used

Organization and Method of Use

This user's manual explains the use of the system and its associated devices in the following order:

Chapter 1

This chapter explains the configuration of measuring systems based on this product, the structure of this product and the names and functions of their respective parts.

Chapter 2

This chapter explains the installation and wiring of the system. Persons in charge of the installation of this unit, the piping installation, and the wiring should refer to this chapter.

Chapter 3

This chapter explains the procedures for starting-up, operating, and stopping this product. Two operating methods are explained; one uses the data setting device of this product. Read this chapter when using this product just after installation or after the operation of this product has been halted.

Chapter 4

This chapter explains the operation of this product using the data setting device.

Chapter 5

This chapter describes the procedures to be followed for maintenance and checking of this unit and for troubleshooting. Refer to this chapter when performing maintenance and troubleshooting.

Detailed Table of Contents

Chapter 1 -	Configuration and Structure of the Measuring Systems	1 - 1
	Outline of this chapter	1 - 1
1.1	System Configuration	1 - 2
	Measuring System	1 - 2
1.2	Structure of this Unit and Functions of Parts	1 - 4
	Structure of the Device	1 - 4
Chapter 2 -	Installing the Device	2 - 1
	Outline of this chapter	2 - 1
2.1	Before Installation	2 - 2
	Selecting the Installation Site (1)	2 - 2
2.2	Installation Method	2 - 3
	Installing the Converter	2 - 3
	Electrical Wiring (1)	2 - 5
	Electrical Wiring (2)	2 - 7
	Electrical Wiring (3)	2 - 10
	Electrical Wiring (4)	2 - 11
Chapter 3 -	Operating and Stopping of the Measuring System	3 - 1
	Outline of this chapter	3 - 1
3.1	Start-up	3 - 2
3.2	Preparations before Measurement	3 - 3
	Zero Adjustment (1)	3 - 3
	Method Using the Data Setting Device	3 - 4
3.3	Stopping	3 - 6
3.4	Setting Write Protection	3 - 7
Chapter 4 -	Operation Using the Data Setting Device	4 - 1
	Outline of this chapter	4 - 1
4.1	Functions of the Data Setting Device	4 - 2
	Data Setting Device	4 - 2
	Operating the Display/Data Setting Device	4 - 5
	Screen Organization	4 - 7
	Measuring Mode	4 - 9
	How to Skillfully Operate the Touch Key Switches	4 - 10
	How to Enter the Operator's Mode	4 - 11
	Operating in Operator's Mode	4 - 12
	Resetting the Damping Time Constant	4 - 13
	Zero Adjustment	4 - 14
	Setting/Changing the Flow Rate Indication	4 - 16
	Selecting Modes	4 - 17
	Engineering Mode	4 - 19
	Setting the ID	4 - 20
	Detector Data Setup	4 - 21
	Setting the Range	4 - 23
	Setting the Specific Gravity	4 - 24
	Setting alarm contact 1	4 - 25
	Setting alarm contact 2	4 - 26
	Setting alarm hysteresis	4 - 27

Maintenance Mode	4 - 28
------------------------	--------

Chapter 5 -	Maintenance and Troubleshooting of the Electromagnetic Flowmeter	5 - 1
	Outline of this chapter	5 - 1
5.1	Functions Check	5 - 2
	Checking alarm contact output	5 - 2
	Checking the Excitation Current	5 - 3
	False Signal Input by Calibrator	5 - 4
5.2	Troubleshooting	5 - 5
	Overview	5 - 5
	Errors at Start-up	5 - 6
	Errors during Operation	5 - 7
	Error Messages and Treatment (Display)	5 - 8

Chapter 1 - Configuration and Structure of the Measuring System

Outline of this chapter

This chapter explains the configuration of measuring systems using this unit.

- The structure of this unit and the names and functions of its respective parts are explained.
-

1.1 System Configuration

Measuring System

Introduction

Depending on the way it is combined with the detector, this product is available in two configurations; integral and remote.

- Integral: detector and converter are installed as an integrated unit on the pipe.
- Remote: detector and converter are installed separately and connected by a cable.

Examples of flow measurement systems

Figures 1-1 and 1-2 show examples of measurement systems using the device.

Figure 1-1 Integral configuration

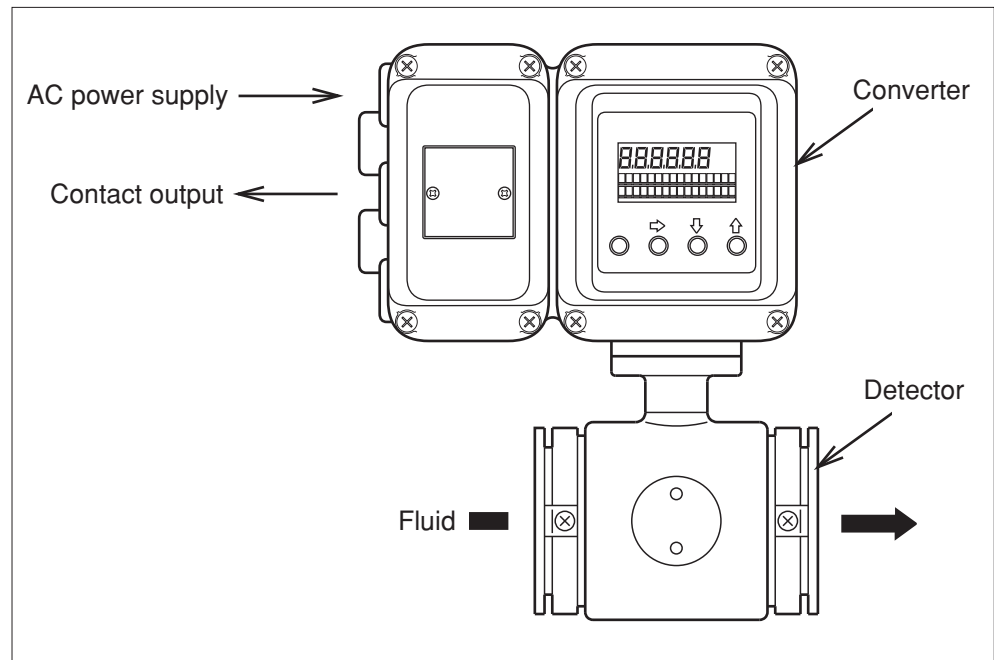

(Continued on next page)

Measuring System *(Continued)*

Examples of flow measurement systems

Figure 1-2 Remote configuration

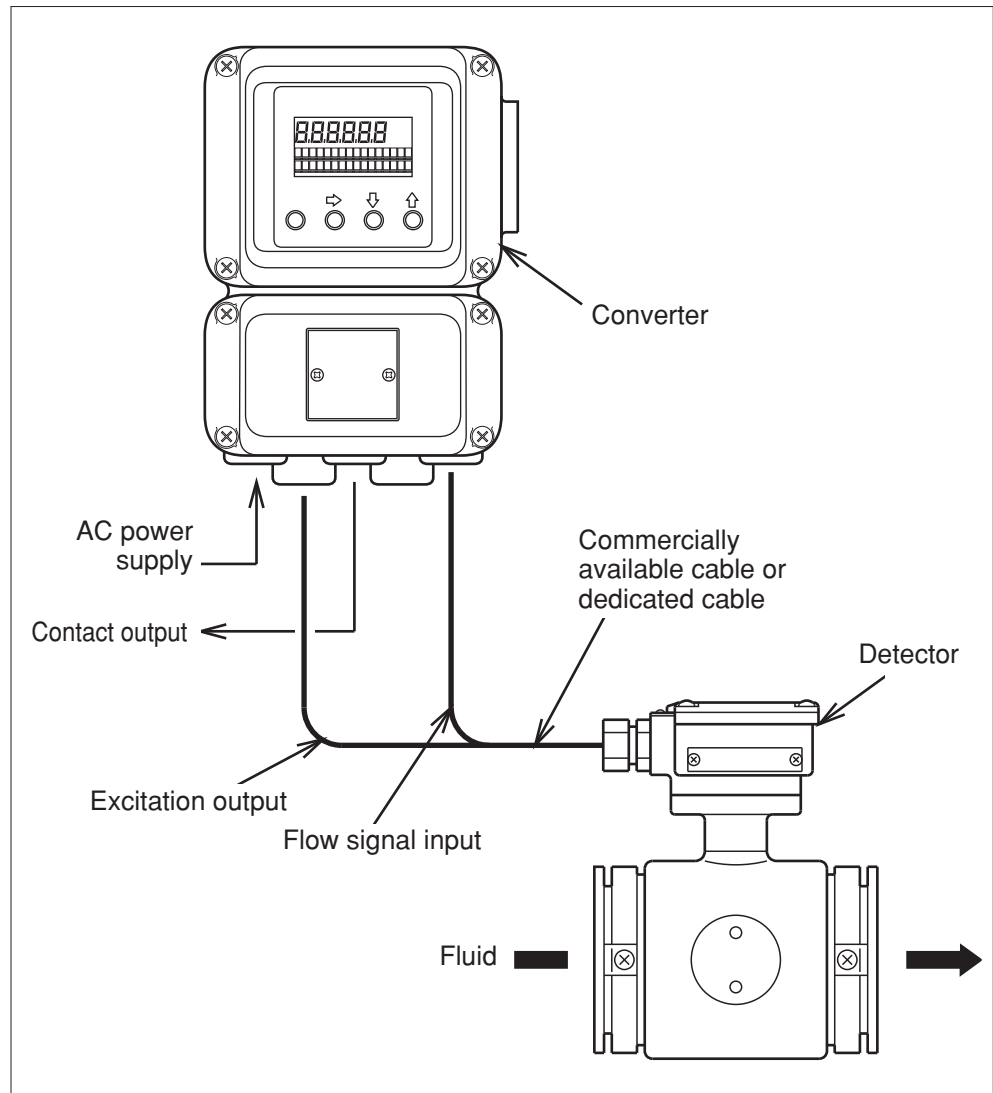

1.2 Structure of this Unit and Functions of Parts

Structure of the Device

Main components

This unit consists of the converter main body, the contact I/O card, data setting device, and a terminal box.

Figure 1-6 Structure of the main body

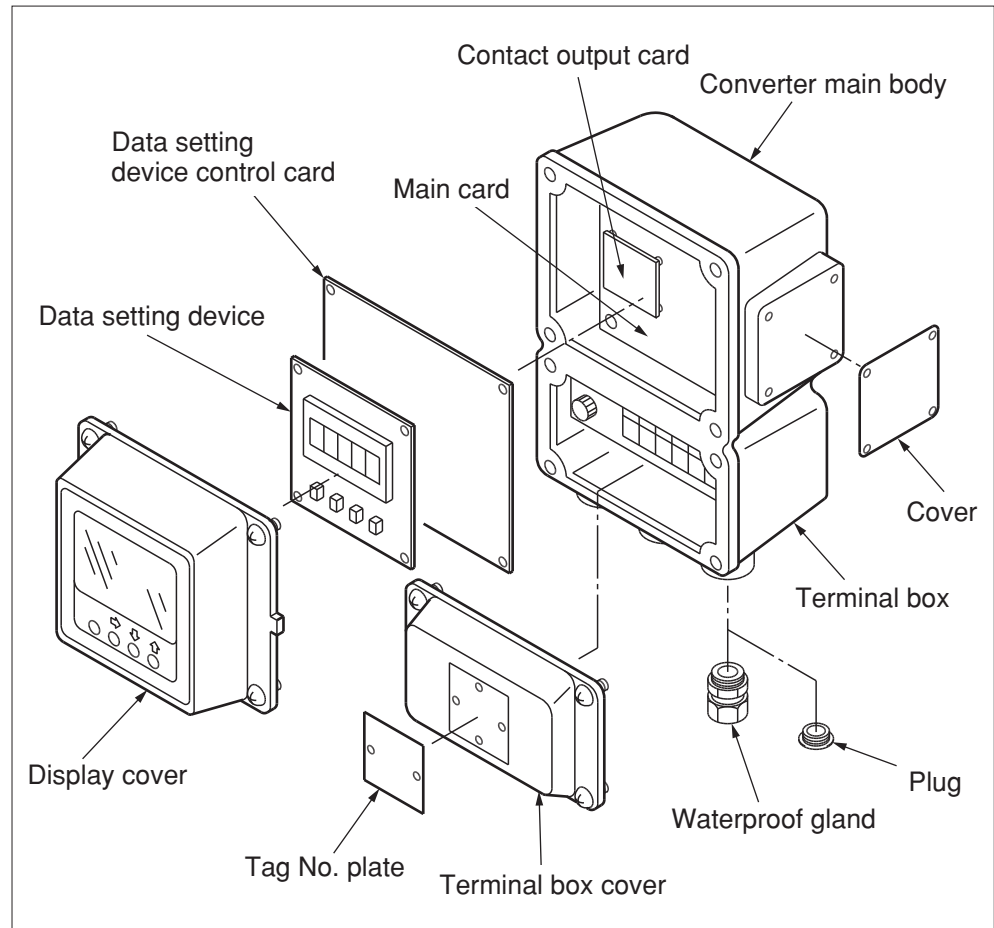

(Continued on next page)

Structure of the Device *(Continued)*

Converter parts and explanation

The following table explains the various parts.

Name	Explanation
Converter main body	<ul style="list-style-type: none">• Converts signal electromotive force generated in the detector into the instantaneous flow rate.
Data setting device	<ul style="list-style-type: none">• Indicates the instantaneous flow rate.• The flowmeter functions can be changed using the four keys on the panel.
Terminal box	<ul style="list-style-type: none">• Encloses the input/output terminals.• Contains an integrated 12 kV, 100 A isolator.
Nameplate	<ul style="list-style-type: none">• Indicates model number, the product number, and the detector constant (EX) .
Tag No. plate	<ul style="list-style-type: none">• Indicates tag number as specified in the product order.

MEMO

Chapter 2 - Installing the Device

Outline of this chapter

This chapter explains the installation and wiring procedures of the device in the following order.

- Selecting the installation site
 - Adjusting the data setting device direction
 - Installing the device
 - Signal line wiring
-

2.1 Before Installation

Selecting the Installation Site (1)

Introduction

In order to make full use of the device functions, please observe the following criteria when selecting an installation site.

Notes :

- Install the product in a location with an ambient temperature of -25°C - $+60^{\circ}\text{C}$ and an ambient humidity of 5 - 100% RH to prevent equipment malfunction or output errors.
 - Avoid installing the product near high-current power lines, motors, or transformers to prevent damage from electromagnetic induction, which may cause equipment malfunction or output errors.
 - DO NOT use this product for grounding a welder, as it may cause damage to the product.
 - When welding near this product, be sure to ground the welding power transformer.
 - Avoid locations subject to severe vibration or highly corrosive atmospheres to prevent detector breakage or equipment damage.
 - Keep the product away from direct sunlight, wind, and rain to prevent output errors.
-

2.2 Installation Method

Installing the Converter

Basic installation method Installation

A converter can be mounted in one of four ways, an integrated unit with a sensor and an elbow, an integrated unit, mounting on a wall and mounting on a 2-inch pipe.

Figure 2-1 Wall-mounted

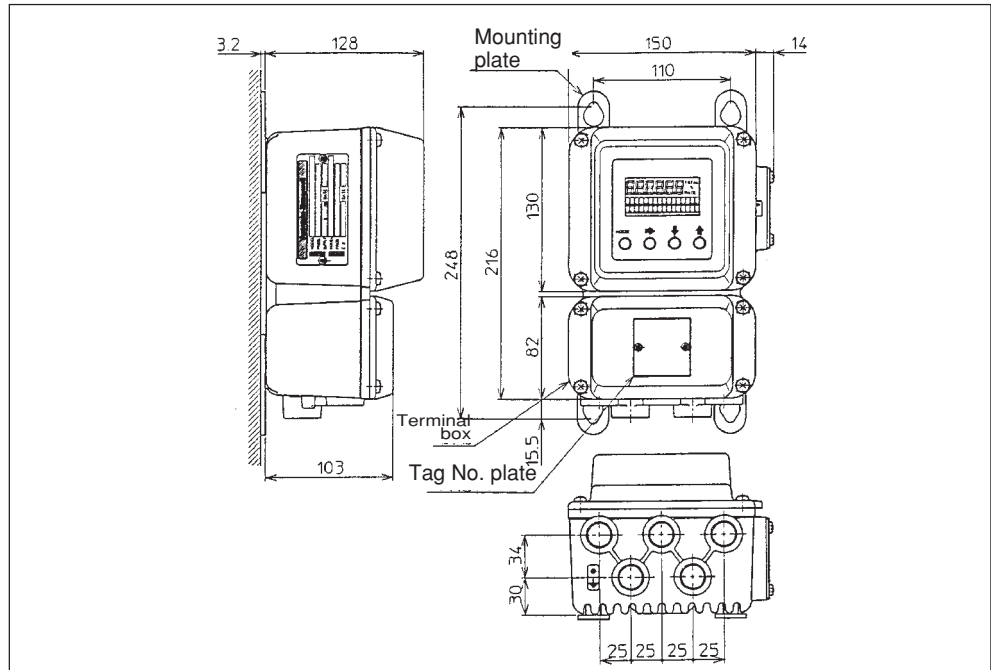
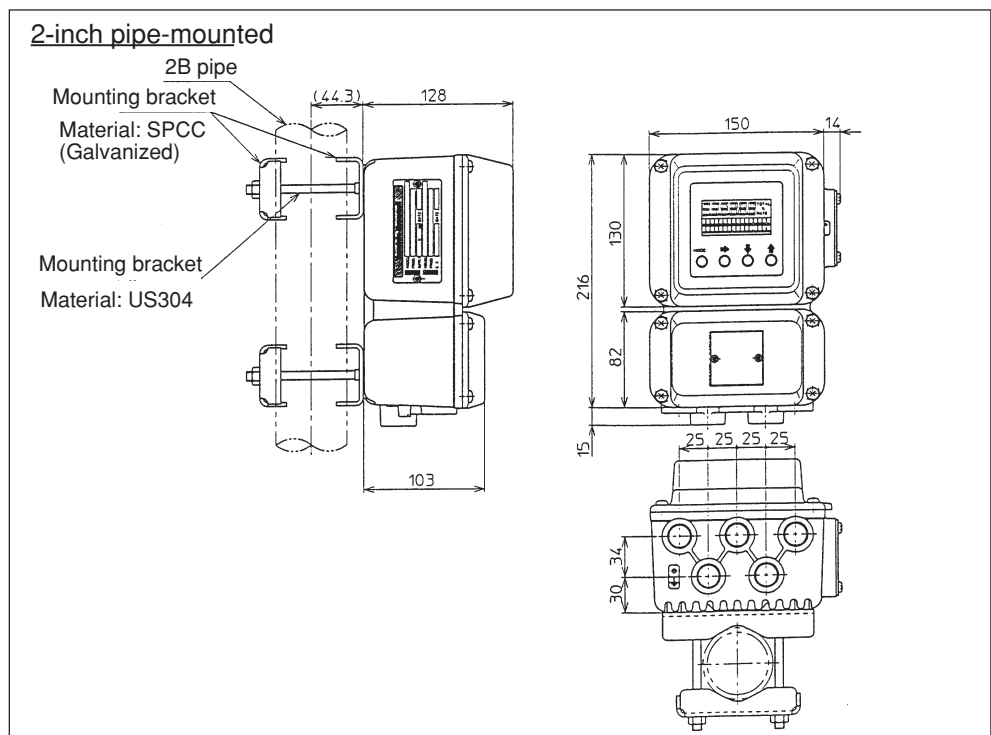

Figure 2-2 2-inch pipe-mounted



(Continued on next page)

Installing the Converter *(Continued)*

Basic installation
method
Installation

Figure 2-3 Integral assembly

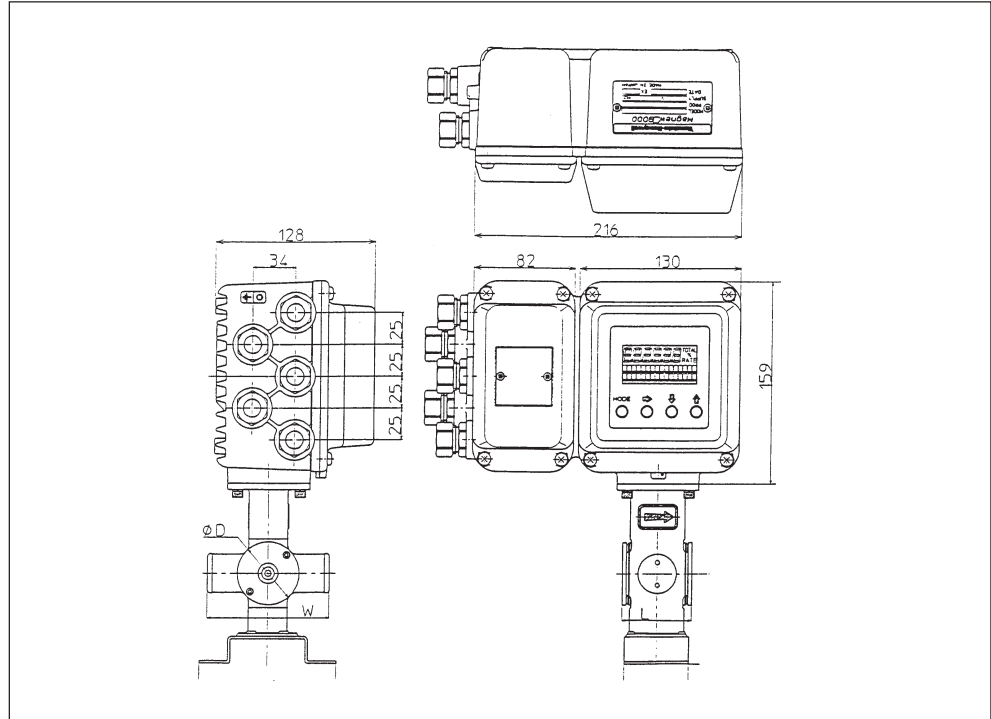
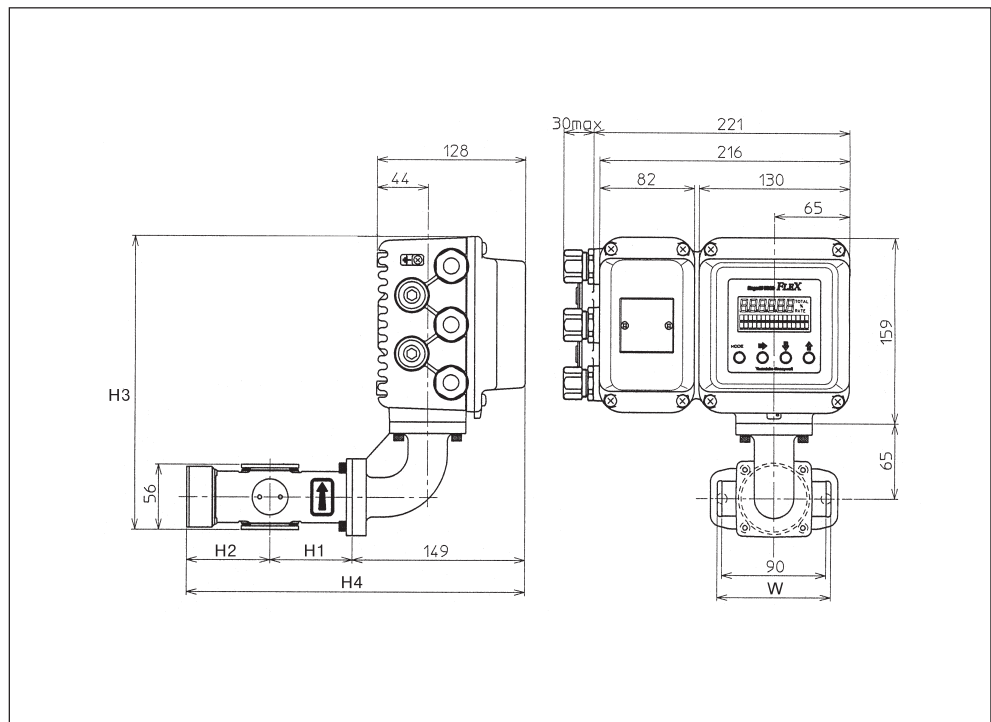

Figure 2-4 Mounting of Integrated Type with an Elbow



Electrical Wiring (1)

Introduction

A commercial power supply or DC 24 V \pm 10% power supply is used. The following electrical wiring considerations are explained here.

- Cable connection positions
 - Power supply and resistive load
 - Cable selection and installation
 - Grounding
 - Wiring procedure
-

Connecting positions for the electromagnetic flowmeter main body

Figure 2-5 (below) shows the terminal block of the electromagnetic flowmeter main body.

 Warning
--

- | |
|---|
| <ul style="list-style-type: none">• During wiring, turn OFF the power supply before opening the cover in order to prevent the danger of electric shock.• DO NOT perform wiring work while the power is ON, as it may result in electric shock. |
|---|

Notes :

- Perform wiring according to the directions in order to prevent equipment damage.
 - Be sure to check the power line wiring positions carefully, as a high-voltage power flow is used.
-

(Continued on next page)

Electrical Wiring (1) *(Continued)*

Terminal
arrangement

2-contact output

E	⊕	AL1			AL2		SB	SA	C	A
		NC	NO	C	C					
POWER		X	Y	AL2					B	
+	-			NC	NO					

Terminal arrangement for integral converter

On an integral converter, terminal symbols X, Y, SB, SA, A, B, C, and E are not indicated as on the remote converter, because these terminals are not used.

Electrical Wiring (2)

Cable between detector and converter

Use a dedicated cable (Model: MGA12W) to connect the detector to the converter. The signal cable used may be a dedicated cable made by Azbil Corporation or a commercially available cable and depends on fluid conductivity, cable length, and the diameter of the detector.

Please refer to the following:

- Dedicated Azbil Corporation cable usage range: ranges (A) and (B)
- Other cable usage range: (A) only

Figure 2-5 Relation between fluid conductivity and cable length

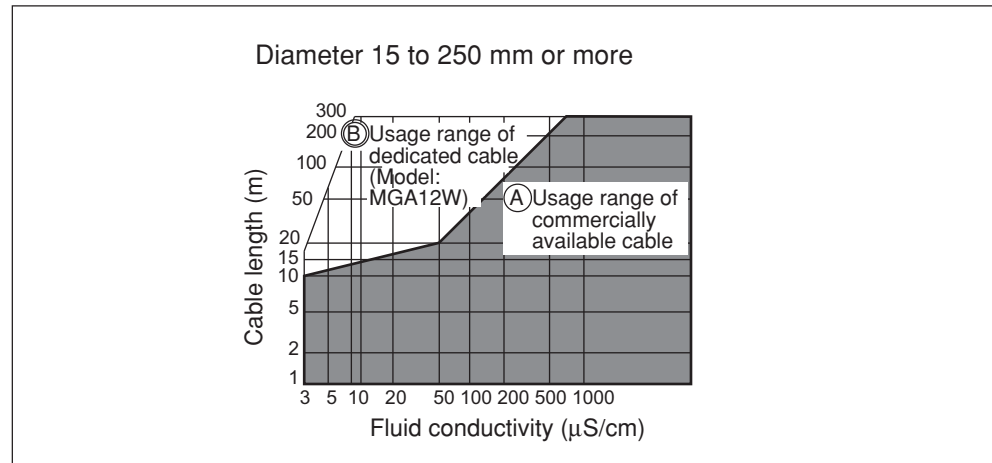

Cable specifications

Cable (between remote detector and converter):

Length: Max. 300 m (Depends on fluid conductivity)

Outer diameter: 10 - 12 mm

Signal cable:

Dedicated cable (Diameter 11.4 mm, 0.75 mm²) or equivalent commercially available cable (e.g. CVVS, CEEV)

Excitation cable:

Dedicated cable (Diameter 10.5 mm, 2 mm²) or equivalent commercially available cable (e.g. CVV)

Note: Be sure to use shielded cables for signal cables.

(Continued on next page)

Electrical Wiring (2) *(Continued)*

Excitation Cables (Model: MGA 12W)

Figure 2-8 Outer Dimensions of Excitation Cables

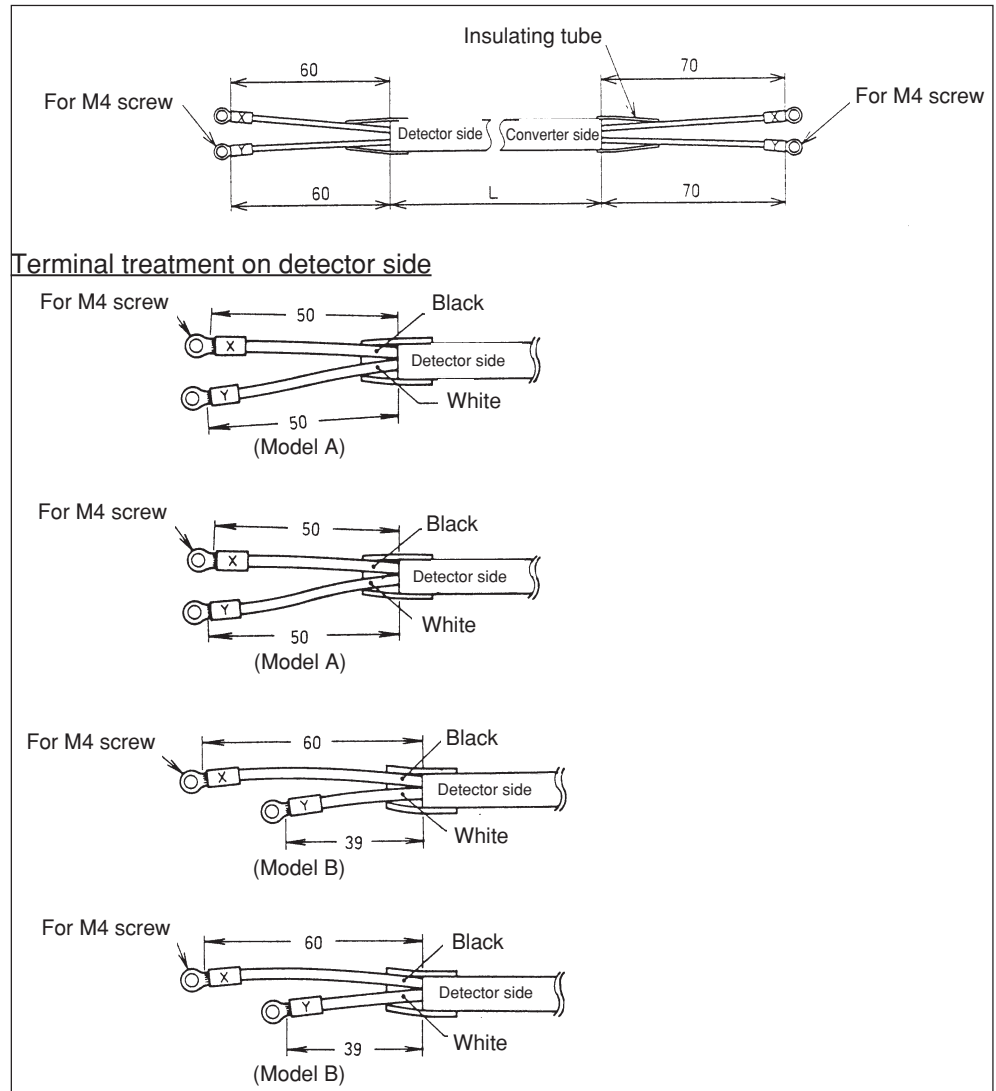
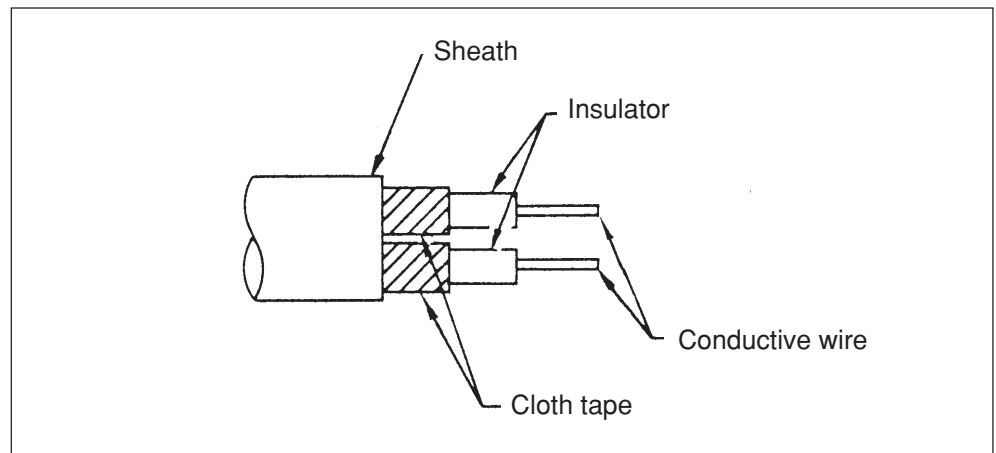

Figure 2-9 Excitation Cable Construction



Electrical Wiring (3)

Detector-to-converter connection

Figure 2-10 Detector-to-converter connection

- Wiring of dedicated cables (Model: MGA12W)

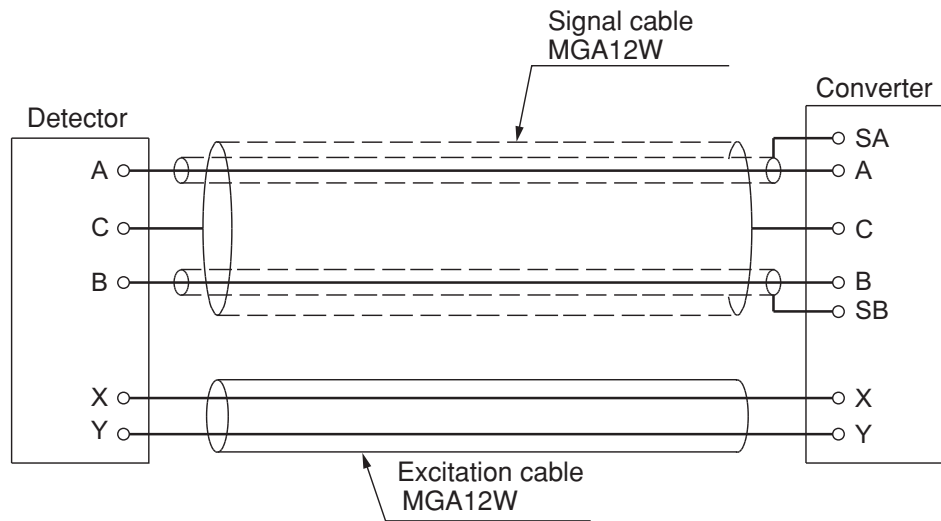

- Commercially available cable

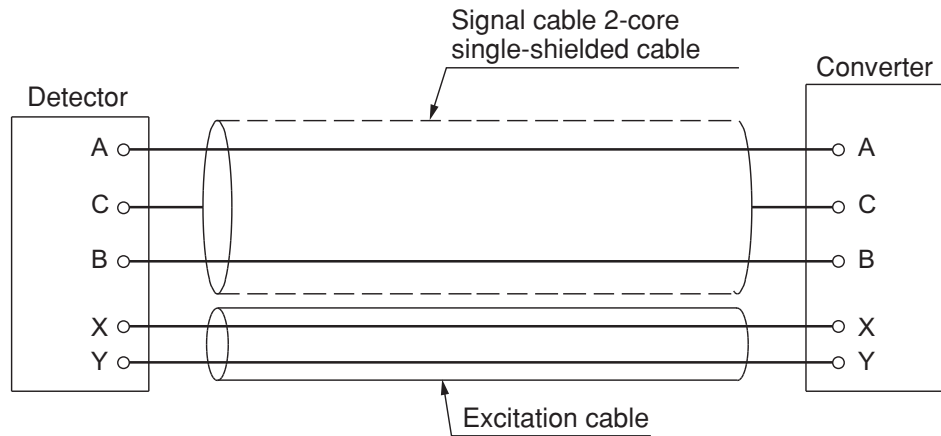

Electrical Wiring (4)

Selecting the wiring cable

The recommended wiring cable is a 600 V vinyl sheath electrical wire CVV (JIS C 3401) with a conductor section of 2 mm², or a twisted cable with an equivalent or higher capacity.

Shielded wire is recommended for wiring at locations subject to electromagnetic noise interference.

Select a sheath material suitable for the cable installation environment (consider ambient temperature, corrosive gas, corrosive fluid, etc.).

Run the cable into the terminal block through the conduit connection (G1/2 internal thread, CM20 external thread, Pg13.5 or 1/2NPT internal thread). An outer diameter of $\phi 11$ is optimum. (The applicable range of cable outer diameters is $\phi 10 - \phi 12$.)

A crimp terminal (M4 screw) with an insulation sleeve is recommended for the terminal connections.

The maximum length of the wiring cable is 1500 m. However, the maximum length between converter and detector is 300 m.

Installing the wiring cable

When installing the cable connecting this product to the control equipment, the following precautions must be observed.

Notes:

- Run the wiring away from equipment that may cause noise, such as high-capacity transformers, motors, or power supplies. DO NOT install the cable in the same tray or duct as other power cables. Output errors may result.
 - Wiring with electrical tube and duct is recommended to keep out water and protect the wire from external damage. Also, be sure to use a waterproof gland at the conduit connection.
-

MEMO

Chapter 3 - Operating and Stopping of the Measuring System

Outline of this chapter

This chapter explains the procedures for starting up this product and making zero adjustment. It also describes stopping the system.

When starting up and operating this product for the first time, carefully follow the explanation given in this chapter.

Zero adjustment is performed by using the data setting device.

Before using this product, be sure to perform the following settings as instructed in this chapter.

- Setting the write protect level
- Setting the empty detection function

3.1 Start-up

Starting up

Procedures

Start up the electromagnetic flowmeter according to the following steps.

Step	Procedure
1	Make sure the electromagnetic flowmeter detector is properly installed on the pipe.
2	Make sure the wiring between the detector and converter has been completed properly.
3	Charge the converter with the fluid to be measured, and make the fluid stand still.
4	Make sure there is no fluid leaking from the flange to which the converter is attached.
5	Turn the power to the electromagnetic flowmeter ON.
6	Make a display similar to the one shown below appears on the LCD. <div data-bbox="833 1128 1251 1339" data-label="Image"><p>The image shows a rectangular LCD display with a black background and white text. At the top, it displays '0.0' in a large digital font, followed by a '%' symbol. Below this, it shows 'SPAN 0300.0 m3/h' on one line and 'AL1 70%' and 'AL2 50%' on the next line.</p></div>
	Start-up has now been completed.

3.2 Preparations before Measurement

Zero Adjustment

Introduction

After start-up, be sure to zero the electromagnetic flowmeter. Zero adjustment is performed by using the data setting device.

Method by Using the Data Setting Device

Introduction





Adjust the electromagnetic flowmeter so that the instantaneous flow when the fluid in the detector stands still is measured as zero.

Notes:

- Zero adjustment is very important for accurate flow rate measurement.

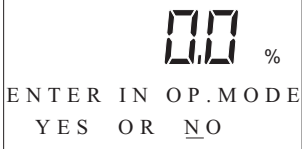
Be sure to zero the flowmeter before it is first operated.



- Before zero adjustment, make sure the detector is correctly Class 3 grounded and that the fluid to be measured has been charged and stands still in the detector. Zero adjustment becomes possible when the flow speed is 0.2 m/s or less, but wait until the fluid completely stops (Flow speed: 0.0 m/s) for accurate adjustment. Otherwise, output errors may result.

Step	Procedure	Screen
1	Touch the MODE key for more than 3 seconds. Note: The screen at left will be displayed for 8 seconds. Complete the following operations within 8 seconds.	
2	Touch the MODE key on the data setting device for more than three second to enter the Operator Mode. Touch the  key to display the screen shown. Note: This is the screen when the main display is set to % units.	
3	Touch the  key once.	

(Continued on next page)

Method Using the Data Setting Device *(Continued)*

Method using the data setting device

Step	Procedure	Screen
4	Touch the  key to start zero adjustment. During adjustment, when the large 7-segment displays the flow rate in %, "0.0" will be flashing. When zero adjustment is completed, the flashing will stop and the "ON" message will return to "READY". Zero adjustment takes about 30 seconds.	 <p>The screenshot shows a digital display with '0.0' and a '%' symbol. Below the display, the text '* AUTO ZERO' is visible, and 'ON' is displayed at the bottom of the screen.</p>
5	Lastly, be sure to end the operation by touching the MODE key.	

3.3 Stopping

 Caution
--

- | |
|---|
| <ul style="list-style-type: none">• Before stopping the flowmeter operation and shutting off the output to the control equipment, be sure to switch the control equipment to manual control. This will prevent the power shut-off on this unit from directly affecting the control equipment. |
|---|

Procedures

Perform the following steps to stop flowmeter operation.

Step	Procedure
1	Switch the control equipment connected to the flowmeter to the manual control mode.
2	Turn the power switch of the flowmeter OFF.

3.4 Setting Write Protection

Introduction

This product is set up at shipment so that settings can be made in any mode. However, write protection can be set to protect data from being accidentally changed after start-up.

Levels of write protect





The following write-protect levels are available. The product is set to level 0 when shipped.

Level	Operator's Mode	Engineering Mode	Maintenance Mode	Remarks
0	○	○	○	When shipped
1	○	○	×	
2	○	△	×	
3	△	△	×	

- : Both data confirmation and manipulation are possible.
- △: Only data confirmation is possible.
- ×: Neither data confirmation nor manipulation is possible.

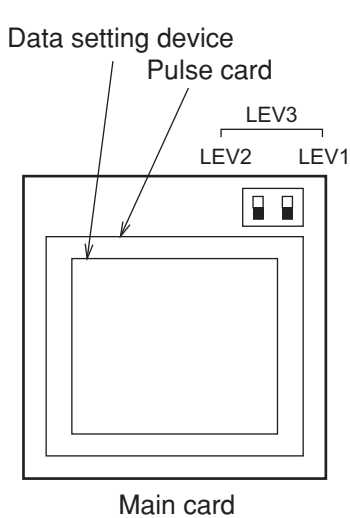
Procedure 1

To change the write-protect level, set the switches in the following steps.

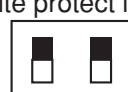
Step	Procedure
1	Remove the display cover.
2	<p>The switches are located on the main card. Set switches LEV1, LEV2, and LEV3 on the top of the card as shown below. (Move the switches to the blackened positions.)</p>  <div style="display: flex; flex-direction: column; align-items: flex-end; margin-top: 20px;"> <div style="margin-bottom: 10px;">Write protect level 0 </div> <div style="margin-bottom: 10px;">Write protect level 1 </div> <div style="margin-bottom: 10px;">Write protect level 2 </div> <div>Write protect level 3 </div> </div>

MEMO

Chapter 4 - Operation Using the Data Setting Device

Outline of this chapter

This chapter explains how to operate this product using the data setting device.

The device can be operated using the 4 keys on the data setting device.

4.1 Functions of the Data Setting Device

Data Setting Device

Names of parts

Figure 4-1 shows describes the parts of the data setting device.

Figure 4-1 Names of data setter parts

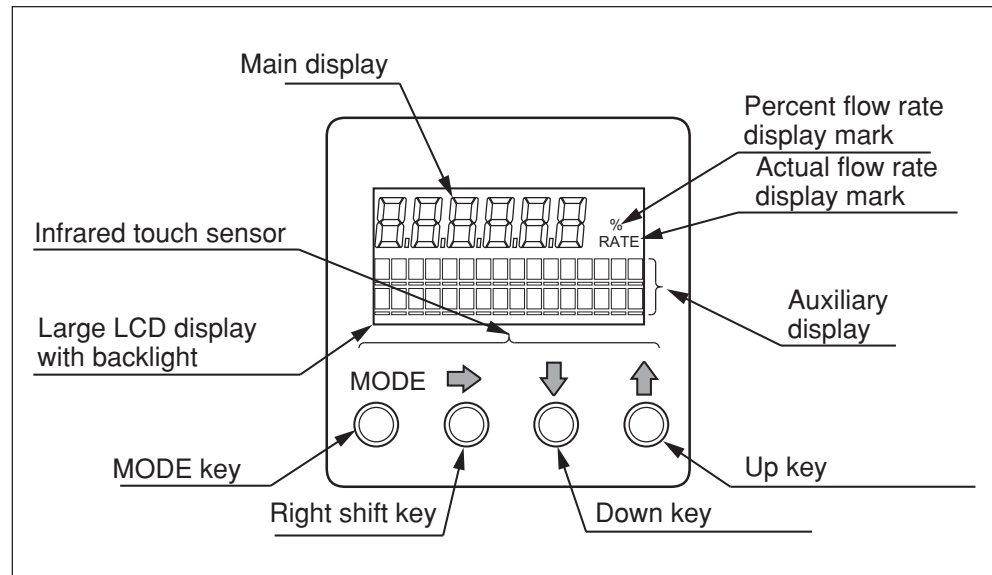

Part names and explanation

The display that appears on the data setting device is explained below.

- Flow rate indication
The display indicates “%” for percent flow rate, “RATE” for actual flow rate.

Section	Explanation
7-segment 6-digit display	<ul style="list-style-type: none"> • Indicates the flow rate selected in the Operator’s Mode.
Percent flow rate indicator (%)	<ul style="list-style-type: none"> • Indicates that percent flow rate is currently displayed.
Actual flow rate indicator (RATE)	<ul style="list-style-type: none"> • Indicates that actual flow rate is currently displayed.
Auxiliary display	<ul style="list-style-type: none"> • During the Measuring Mode, indicates a flow rate to supplement the flow rate indication selected in the Operator’s Mode. • Indicates the procedures for parameter setting, adjustment, etc. when not in the Measuring Mode.

(Continued on next page)



Data Setting Device *(Continued)*

Part names and explanation

The following is an explanation of the various keys on the data setting device.

- When operating the keys, be sure to close the cover. Only touch the keys through the glass.
- When operating the keys, touch the glass lightly, targeting the central part of each key.

Hold down the  or  key to scroll the characters up to 40 times.

Name	Explanation
<p>MODE key</p> <p>MODE</p> 	<ul style="list-style-type: none"> • Enter the Operator's Mode. • After changing the parameters or internal data in the Engineering Mode or Maintenance Mode, press this key to write the data into memory. • Touch this key for more than one second to complete the write.
<p>Right-shift key</p> 	<ul style="list-style-type: none"> • Shift the cursor to the right.
<p>Down key</p> 	<ul style="list-style-type: none"> • Change the parameter at the cursor position. • Display the previous screen. <p>When the cursor is located at the far left of the upper row (*, #, >)</p> <div style="border: 1px solid black; padding: 5px; margin-bottom: 10px;"> <p>* OPERATOR'S MODE</p> <p>Cursor</p> </div> <p>Changes the screen.</p> <p>When the cursor is located at a numerical figure</p> <div style="border: 1px solid black; padding: 5px; margin-bottom: 10px;"> <p>* DAMPING 001.0 S</p> <p>Cursor</p> </div> <p>Decrements the numerical figure.</p> <p>When the cursor is located at the decimal point</p> <div style="border: 1px solid black; padding: 5px;"> <p>* SPAN 1.000 m/s 07.069 m³/h</p> <p>Cursor</p> </div> <p>Moves the decimal point to the right.</p>

(Continued on next page)

Data Setting Device *(Continued)*

Part names and explanation

Name	Explanation
<p>Up key</p> 	<ul style="list-style-type: none"> • Change the parameter at the cursor position. • Display the next screen. <p>When the cursor is located at the far left of the upper row (*, #, >)</p> <div data-bbox="810 577 1238 712" style="border: 1px solid black; padding: 5px;"> <p>* OPERATOR'S MODE</p> <p>Cursor</p> </div> <p>Changes the screen.</p> <p>When the cursor is located at a numerical figure</p> <div data-bbox="810 797 1238 931" style="border: 1px solid black; padding: 5px;"> <p>* DAMPING 001.0 S</p> <p>Cursor</p> </div> <p>Increments the numerical figure.</p> <p>When the cursor is located at the decimal point</p> <div data-bbox="810 1016 1238 1151" style="border: 1px solid black; padding: 5px;"> <p># SPAN 1.000 m/s 07.0690 m³/h</p> <p>Cursor</p> </div> <p>Moves the decimal point to the left.</p> <p>When the cursor is located at "READY"</p> <div data-bbox="810 1236 1238 1370" style="border: 1px solid black; padding: 5px;"> <p>* AUTO ZERO READY</p> <p>Cursor</p> </div> <p>Starts operation when touched.</p>

Operating the Display/Data Setting Device

Outline of the various modes

The following 4 modes are available on the device.

Mode	Explanation
MEASURING MODE	This mode indicates the measuring status.
OPERATOR'S MODE	<p>The operator setting mode is used for data that are registered or changed frequently. The settings can be changed at start-up and on other occasions when write protect is set to level 0, 1, or 2. With level 3, only configuration data monitoring is available. Includes damping time constant, auto zero adjustment, counter reset, counter preset value.</p> <p>Note:</p> <ul style="list-style-type: none">Registered or changed data is temporarily written in to memory when input, but will return to the previous status within two minutes unless it is saved. (exception: only counter reset will not return to the previous status even after 2 minutes.) <p>To save the data, be sure to press the MODE key to open the Measuring Mode.</p> <p>When the mode changes to the Measuring Mode, the data will be written into memory.</p>

(Continued on next page)

Operating the Display/Data Setting Device *(Continued)*

Outline of the various modes

Mode	Explanation
ENGINEERING MODE	<p>This is the engineering setting mode. It is used for data that are registered or changed less frequently than in the Operator's Mode.</p> <p>Settings can be registered or changed when write protect is set to level 0 or 1. When the level is 2 or 3, only configuration data monitoring is available. Includes ID function setting, detector data, flow rate span, hysteresis width, output at error.</p> <p>Note:</p> <ul style="list-style-type: none"> When registering or changing data, be sure to press the MODE key to write it to non-volatile memory. Rewriting occurs when the mode is changed to the Measuring mode by pressing the MODE key.
MAINTENANCE MODE	<p>This is the maintenance setting mode. It is used when adjustment or verification is needed at regular maintenance periods or when an abnormality occurs. Settings can be adjusted or confirmed only when the write protect level is set at 0. Includes loop check, output adjustment, gain adjustment.</p> <p>This mode is further divided into the following 3 modes:</p> <p style="padding-left: 40px;">OUTPUT CHECK MODE CALIBRATION MODE CRITICAL MODE</p> <p>Notes:</p> <ul style="list-style-type: none"> Calibration Mode and Critical Mode contain adjustments and operations that are very important for flow rate measurement. When operating these modes, fully check the details of the adjustments to be made. Missetting will prevent measurement. When registering or changing data, be sure to press the MODE key to write it to non-volatile memory. Rewriting occurs when the mode is changed to the Measuring mode by pressing the MODE key.

Screen Organization

Introduction

The device modes are arranged as follows.

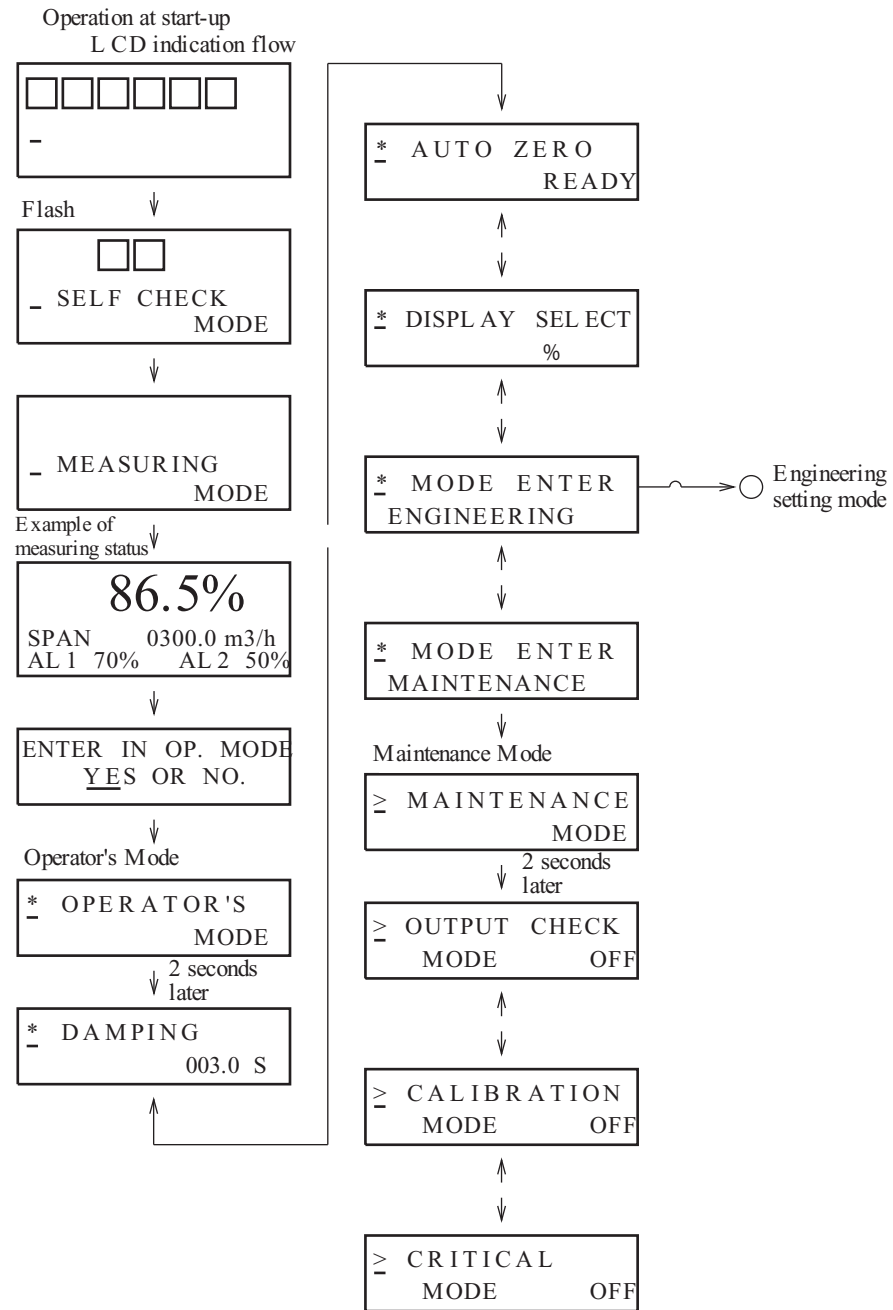

(Continued on next page)

Screen Organization *(Continued)*

Introduction

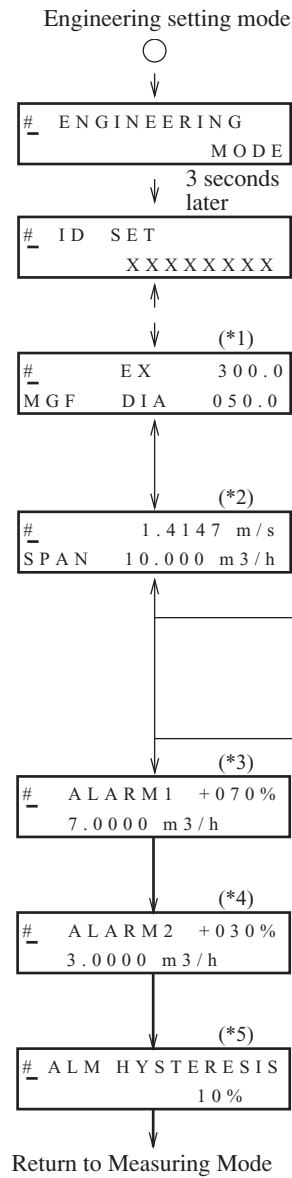

- (*1) The aperture ranges from 15 to 250 mm.
- (*2) This is displayed when the unit specification is weight.
- (*3) , (*4) Make sure that the following condition is met: $ALARM1 \geq ALARM2$.
- (*5) A whole number within the range of 0 - 20% (in 1% units) can be selected as the hysteresis value. Make sure that the following condition is met: $ALARM1 + HYS \leq 100\%$.

MEASURING MODE

Introduction

The MEASURING MODE is an ordinary measurement mode. Screen displays in the normal state (the flow rate exceeds the alarm values) and the abnormal state (the flow rate is equal to or below the alarm values) are explained below.

Normal state (% flow rate display)

Top line : Momentary % flow rate
 Middle line : Span
 Bottom line : Alarm value 1 (% display), Alarm value 2 (% display)
 (Format) (Example)

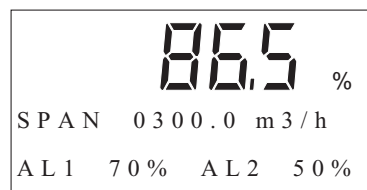
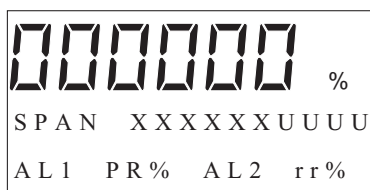

XXXXXX ... Actual flow rate span (6 digits)
 UUUU ... Unit of actual flow rate span (4 digits)
 RR ... % flow rate alarm value 1 (2-digit integer number within 0 - 99)
 rr ... % flow rate alarm value 2 (2-digit integer number within 0 - 99)

Normal state (Actual flow rate display)

Top line : Momentary actual flow rate
 Middle line : Span
 Bottom line : Alarm value 1 (% display), Alarm value 2 (% display)
 (Format) (Example)

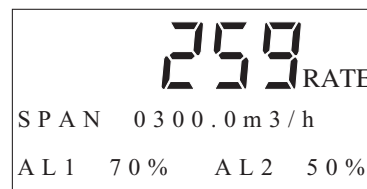
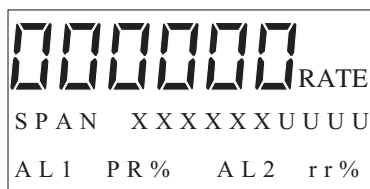

XXXXXX ... Actual flow rate span (6 digits)
 UUUU ... Unit of actual flow rate span (4 digits)
 RR ... % flow rate alarm value 1 (2-digit integer number within 0 - 99)
 rr ... % flow rate alarm value 2 (2-digit integer number within 0 - 99)





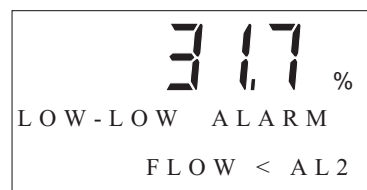
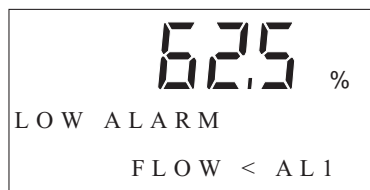

Abnormal state

The display format is as follows when the measured data is below the alarm values. (Display in blinking mode)









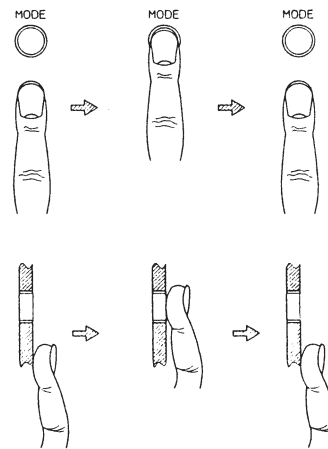

Blinking alternately by 1-second cycles Blinking alternately by 0.5-second cycles
 (The screen shown on the left is not displayed when AL1 is equal to AL2.)

How to Skillfully Operate the Touch Key Switches

1. As illustrated, move your finger upward from underneath the target, and completely cover the white round target.
Then, move the finger downward to its original position.
These motions ensure smooth key operation. If you move your finger sideways, you may inadvertently actuate the wrong key.
2. To enter the MODE key, keep touching the key for 3 seconds. Release the key on completion of screen change to ensure smooth operation. If the screen change is not completed within 3 seconds, move the finger off, and touch the MODE key again 3 seconds later. If you touch the key right away, the input may not be accepted.
3. To enter the , , or  keys in succession (increment or decrement), keep touching the target until the desired display is obtained. Note, however, that the  key stops at the mode signs shown below.
* (OPERATOR'S MODE)
(ENGINEERING MODE)
> (MAINTENANCE MODE)
To move the cursor again, press the  key again.
The  and  keys can be incremented or decremented up to 40 times in succession. If you want to make another key entry, press the key again.



How to Enter the Operator's Mode

Step	Procedure	Screen
1	The screen at right shows an example of display of 10 m ³ /h, 100% in the Measuring Mode. Touch the MODE key for about 3 seconds.	
2	<p>Complete the following operations within 8 seconds (the screen at right will be displayed for about 8 seconds only):</p> <p>1) To enter the Operator's Mode, move the cursor under "Y" by touching the  key twice, and then touch the  key.</p> <p>2) To return to the Measuring Mode, move the cursor under "N" and touch the  key.</p> <p>The screen will automatically return to the Measuring Mode (screen shown in step 1) 8 seconds later.</p>	 
3	The operation mentioned under 1) in the above step will make the screen on the right be displayed for about 2 seconds.	
4	The Damping Setting screen will be displayed about 2 seconds later.	

Operating in Operator's Mode

Introduction

The Operator's Mode includes the following settings and adjustments. To enter the Operator's Mode, touch the MODE key for more than three seconds.

Screen display	Description	Indicated conditions
DAMPING	Sets the damping time constant	
AUTO ZERO	Performs zero adjustment	
DISPLAY SELECT	Sets the flow rate display	
MODE ENTER ENGINEERING	Enters the Engineering Mode	
MODE ENTER MAINTENANCE	Enters the Maintenance Mode	Setting of write protect to level 0.

Details of the screens are explained on the following pages using concrete examples. To display the various screens, enter the Operator's mode and then press the  key.

Note:

- Settings and adjustments made in the Operator's Mode are temporarily written into memory when input. However, the settings will return to their previous status unless the data are saved within 2 minutes. Be sure to save the data by pressing the MODE key at the end of setting/adjustment.

Resetting the Damping Time Constant

Introduction

Set a damping time constant to cut out minute fluctuations when transmitting the measured instantaneous flow rate to the control equipment. Check the amplitude of variation in instantaneous flow output and set the damping time constant to an appropriate value.







The new value of the damping time constant becomes effective at the moment when the setting is changed.

Default setting

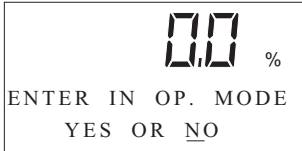
The damping time constant is set to 3 seconds at shipment.

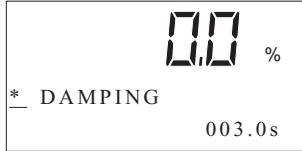
Setting range

The time constant can be set to any value from 000.5 to 199.9.

Step	Procedure	Screen
1	Touch the MODE key for more than 3 seconds. Note: The screen at left will be displayed for 8 seconds. Complete the following operations within 8 seconds.	
2	Touch the MODE key for more than one second.	
3	About 2 seconds after that, the screen will indicate the damping time constant setup display.	
4	Touch the → key three times.	
5	Touch the ↑ or ↓ key to indicate the desired time constant. In this example, damping time is changed from 3 seconds to 10 seconds by six touches of the key ↑. The value can also be changed by holding down the key.	
6	Touch the → key twice.	







Zero Adjustment

Introduction

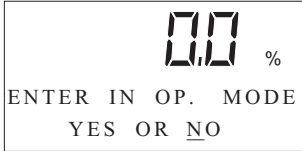
Adjust the flowmeter so that the measured instantaneous flow rate will be zero when the fluid stands still in the detector.

Notes:



- Zero adjustment is very important for accurate flow measurement. Before operating the unit for the first time, be sure to zero the flowmeter.
- Before zero adjustment, make sure the detector has proper Class 3 grounding and that the fluid to be measured is charged into the detector and is standing still. Zero adjustment is possible when the flow speed is 0.2 m/s or below, but wait until the fluid completely stops (flow speed: 0.0 m/s) for accurate adjustment. Otherwise, output errors may result.

Step	Procedure	Screen
1	Touch the MODE key for more than 3 seconds. Note: The screen at left will be displayed for 8 seconds. Complete the following operations within 8 seconds.	
2	Touch the MODE key for more than one second.	
3	Touch the MODE key on the data setting device for more than one second to enter the Operator's Mode. Touch the  key to open the screen shown at right. Note: The figure shows the screen when the main display is set at %.	
4	Touch the  key once.	

(Continued on next page)

Zero Adjustment *(Continued)*

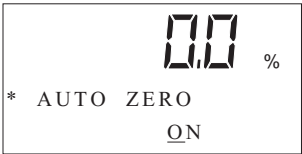
Zero Adjustment

Step	Procedure	Screen
5	Touch the  key to start zero adjustment. When the large 7-segment display shows the flow rate in percent, “0.0” will flash during adjustment. When zero adjustment is completed, the flashing will stop and the “ON” message will return to “READY.” It takes about 30 seconds for zero adjustment.	
6	Touch the  key once.	

Setting/Changing the Flow Rate Indication

Introduction Selects the mode of flow rate indication for the main display: from percent display: actual flow rate display, and integrated value display.

Default setting The default setting is percent display.

Setting range Select either “%” (instantaneous percent flow rate), “RATE” (instantaneous actual flow rate).

Step	Procedure	Screen
1	Open the flow rate display setup screen by following the steps to enter the Operator’s Mode.	<p>The screen shows a digital display of '0.0' followed by a percent sign. Below the display, there are two menu options: '* DISPLAY SELECT' and '%'. A cursor is positioned under the first option.</p>
2	Touch the → key once.	<p>The screen is identical to the previous one, showing '0.0 %' and the menu options '* DISPLAY SELECT' and '%'. The cursor has moved to the second option, '%', indicating it is selected.</p>
3	Touch the ↑ or ↓ key to select the desired flow rate display. In this example, “%” is changed to “RATE” by one touch of the ↑ key.	<p>The screen shows a digital display of '0.000' followed by the word 'RATE'. Below the display, there are two menu options: '* DISPLAY SELECT' and 'RATE'. A cursor is positioned under the second option.</p>
4	Touch the → key once.	<p>The screen is identical to the previous one, showing '0.000 RATE' and the menu options '* DISPLAY SELECT' and 'RATE'. The cursor has moved to the first option, '* DISPLAY SELECT', indicating it is selected.</p>

Selecting Modes



Introduction

Select either the Engineering Mode (to operate the setting parameters of the electromagnetic flowmeter) or the Maintenance Mode (to perform adjustments or inspection).

Note:

- In some cases, a mode selection screen will not open, depending on the write-protect setting. Only the Engineering Mode selection screen will open if the write-protect switches on the main board are used to select level 1, 2, or 3. If level 0 is selected, both the Engineering Mode and the Maintenance Mode will open. Refer to Chapters 3 and 5.

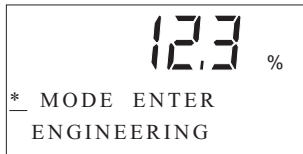
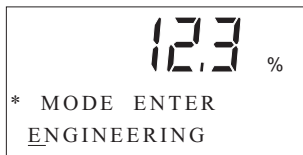
To enter the Engineering Mode









Step	Procedure	Screen
1	Call up the Engineering Mode selection screen by following the steps to enter the Operator's Mode.	
2	Touch the → key once.	
3	Touch the ↑ key, and the display will change to the Engineering Mode.	
4	Two seconds later, the display shown at right will appear.	

(Continued on next page)

Selecting Modes

Introduction

To enter the Maintenance Mode

Step	Procedure	Screen
1	Call up the Maintenance Mode selection screen by following the steps to enter the Operator's Mode.	 <p>12.3 % * MODE ENTER ENGINEERING</p>
2	Touch the  key once.	 <p>12.3 % * MODE ENTER ENGINEERING</p>
3	Touch the  key once.	 <p>12.3 % * MODE ENTER <u>ENGINEERING</u></p>
4	Touch the  key, and the display will change to the Maintenance Mode.	 <p>12.3 % ≥ MAINTENANCE MODE</p>
5	Two seconds later, the display shown at right will appear.	 <p>12.3 % ≥ OUTPUT CHECK MODE OFF</p>

Engineering Mode

Introduction

The Engineering Mode contains the following settings and adjustments.

Screen display	Description	Indicated conditions
ID SET	Sets the ID	
EX, MGF, DIA	Sets detector data	
SPAN	Sets the range	
GRAVITY	Selects the specific gravity	Selection of a weight unit (t, kg, g, lb) in range setting.
ALARM1	Set alarm contact 1.	
ALARM2	Set alarm contact 2.	
ALM HYSTERESIS	Set hysteresis for the alarm contacts.	

Details of the various screens are explained on the following pages. To open the various screens, press the  key after entering Engineering Mode.

Note:









- To write data set in the Engineering Mode to non-volatile memory, press the MODE key. When changing data, be sure to press the MODE key.

Setting the ID

Introduction Sets the ID code for the electromagnetic flowmeter.

Default setting XXXXXXXX

Setting range The ID code can be set using up to 8 alphanumeric characters: letters (A to Z), numbers to 9), -, /, space, and period.

Step	Procedure	Screen
1	Open the ID setup display by following the steps to enter the Engineering Mode.	
2	Touch the  key to move the cursor to the characters to be changed.	
3	Touch the  or  key to change the characters to the desired ones. Use the Right-shift, Down, and Up keys to set up the desired code.	
4	When the desired tag No. is shown, touch the  key to move the cursor to the “*”.	

Detector Data Setup

Introduction











This is used to set and select the constant, and diameter of the detector to be used in combination with the converter.

Default setting

EX300.0, MGF, DIA 050.0 will be selected.

Note:

- When you purchase the converter and detector in combination, your converter will contain the detector data that was set during actual flow calibration. Take care not to change the data, or the flowmeter output will be incorrect. Refer to Table 4-1.

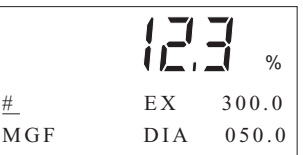
Step	Procedure	Screen
1	Open the detector data setup screen by following the steps to enter the Engineering Mode.	 <p># EX 300.0 MGF DIA 050.0</p>
2	Touch the  key to set the detector constant. Use the  and  keys to input the numerical value printed on the EX column of the detector nameplate.	 <p># EX 320.0 MGF DIA 050.0</p>
3	Touch the  key to select the diameter. Use the  and  keys to select the diameter of the detector to be used.	 <p># EX 300.0 MGF DIA 050.0</p>
4	Use the  key to move the cursor to the "#".	 <p># EX 300.0 MGF DIA 050.0</p>

(Continued on next page)

Detector Data Setup *(Continued)*

Default setting

Table 4-1 Convertor-sensor combinations

○: Allowable setting

Aperture/Sensor Model No.	MGF
15.0	○
25.0	○
40.0	○
50.0	○
65.0	○
80.0	○
100.0	○
125.0	○
150.0	○
200.0	○
250.0	○

Remarks:

- The exciting current value (EX value) setting method varies according to sensor model numbers. Wrong setting can cause errors and equipment destruction.
-

Setting the Range

Introduction

This is used to set the flow rate measurement range, which means the value when the electromagnetic output reaches 100%. The lower limit of the range is zero.

Setting the range

Flow rate: 0.0001 - 99999
 Units: m³, l, cm³, t, kg, g
 Time units: s, min., h, d

When single range is selected

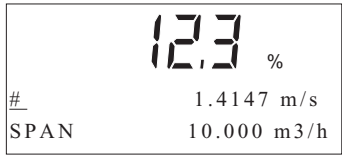
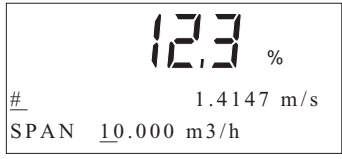
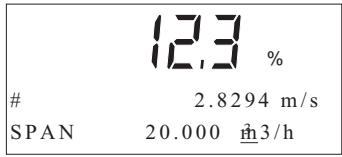
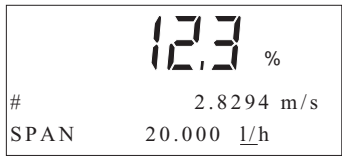
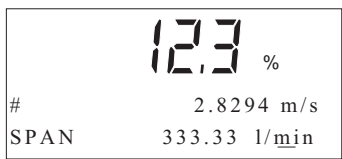
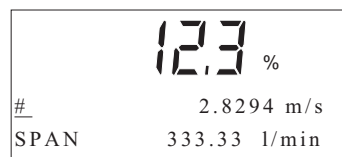







Step	Procedure	Screen
1	Open the range setup screen by following the steps to enter the Engineering Mode.	
2	Touch the → key to move the cursor to the desired digits.	
3	Use the ↑ and ↓ keys to change the numbers.	
4	Touch the → key to move the cursor to the time unit. Use the ↑ or ↓ key to select the desired unit.	
5	Touch the → key to move the cursor to the flow rate unit. Use the ↑ or ↓ key to select the desired unit.	
6	Touch the → key to move the cursor to the "#".	

Setting the Specific Gravity

Introduction This is used to set the specific gravity when selecting a weight unit (t, kg, g) in range setting. Without this setting, an output error may result.

Default setting 1.0000

Setting range 0.1000 - 9.9999







Step	Procedure	Screen
1	Open the specific gravity setup screen by following the steps to enter the Engineering Mode.	 <p>12.3 % # GRAVITY 1.0000</p>
2	Use the  key to move the cursor to the desired numbers.	 <p>12.3 % # GRAVITY 1.00<u>0</u>0</p>
3	Use the  and  keys to change the figures.	 <p>12.3 % # GRAVITY 1.00<u>5</u>0</p>
4	Touch the  key to move the cursor to the "#".	 <p>12.3 % # GRAVITY 1.0050</p>

Setting alarm contact 1

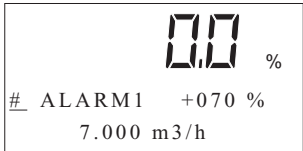
Introduction An alarm is output when the momentary % flow rate value becomes equal to or smaller than the setting.

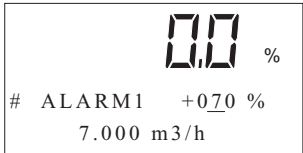
Initial setting 70%

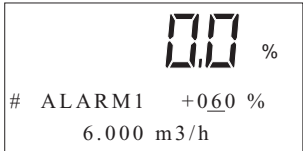
Valid setting range 0 - 99%

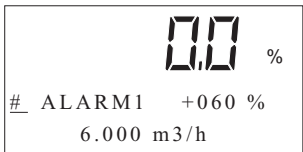
Step	Procedure	Screen
1	Display the alarm contact 1 setting screen according to the procedure used for selecting the ENGINEERING MODE.	
2	Using the  key, move the cursor to the bottom of the digit you want to change.	
3	Using the  or  key, set a new value.	
4	Touch the  key to move the cursor to the bottom of #.	





Make sure that the following condition is met: $ALARM1 \geq ALARM2$.

Setting alarm contact 2

Introduction An alarm is output when the momentary % flow rate value becomes equal to or smaller than the setting.

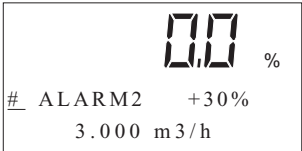
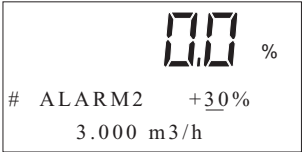
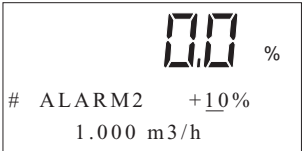
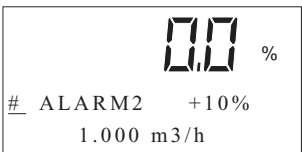
Initial setting 30%

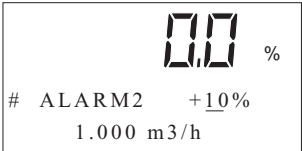
Valid setting range 0 - 99%

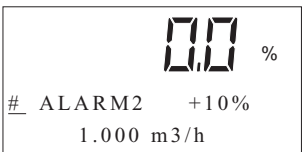
Step	Procedure	Screen
1	Display the alarm contact 2 setting screen according to the procedure used for selecting the ENGINEERING MODE.	
2	Using the  key, move the cursor to the bottom of the digit you want to change.	
3	Using the  or  key, set a new value.	
4	Touch the  key to move the cursor to the bottom of #.	





Make sure that the following condition is met: $ALARM1 \geq ALARM2$.

Setting alarm hysteresis

Introduction Set a hysteresis value for the alarm contacts.

Initial setting 10%

Valid setting range 0 - 20% (in 1% units). Make sure that the following condition is met: $ALARM1 + HYS \leq 100\%$.

Step	Procedure	Screen
1	Display the hysteresis setting screen according to the procedure used for selecting the ENGINEERING MODE.	 <p>00 % # ALM HYSTERESIS 10%</p>
2	Touch the → key once.	 <p>00 % # ALM HYSTERESIS 10%</p>
3	Using the ↓ or ↑ key, input hysteresis value. In this example, 10% was changed to 5%.	 <p>00 % # ALM HYSTERESIS 05%</p>
4	Touch the → key to move the cursor to the bottom of #.	 <p>00 % # ALM HYSTERESIS 05%</p>

Maintenance Mode

Introduction

The Maintenance Mode includes the following adjustments and items to be checked. Refer to Chapter 6 for the operating method.

OUTPUT CHECK MODE

Screen display	Description
ALARM1 CLOSE ALARM2 CLOSE	Check the alarm contact output loop.
EX CHECK	Check the excitation source.

CALIBRATION MODE

Screen display	Description
CAL EX	Adjusts the excitation current
CAL GAIN	Adjusts the converter gain

CRITICAL MODE

Screen display	Description
ROM VER.	Checks the ROM version
ERROR HISTORY	Checks the error history
SHIPPING DATA RECOVERY	Restores the internal data to the status at shipment
INITIAL DATA RECOVERY	Initializes the internal data

Chapter 5 - Maintenance and Troubleshooting of the Electromagnetic Flowmeter

Outline of this chapter

This chapter describes the maintenance and inspection procedures for the electromagnetic flowmeter and the information that should be referred to during troubleshooting.

First, this chapter explains the procedures used to check the converter functions. The items to be checked are as follows.

- Input/output signal loop check
 - Contact output
 - Excitation current
- False signal input by the calibrator

These items serve to aid in early detection of the causes of abnormalities in converter operation.

This chapter also explains the troubleshooting procedures and the initial data recovery procedures.





5.1 Function check

Checking alarm contact output

Introduction Alarm contact output can be checked using an electromagnetic flow switch.

Initial setting CLOSE

Valid setting range CLOSE or OPEN









Step	Procedure	Screen
1	Display the alarm contact output checking screen according to the procedure used for selecting the MAINTENANCE MODE.	
2	Touch the → key to move the cursor to the bottom of the alarm contact you want to check.	
3	Using the ↑ or ↓ key, change to the status you want to check. In the screen on the right, OPEN is output for alarm contact 1.	
4	Touch the → key to move the cursor to the bottom >. The display will return to the analogue output based on the % and actual flow rate in the main display.	
5	When the screen is changed to another screen using the ↑ or ↓ key, the display returns to analogue output based on actual flow rate.	

Checking the Excitation Current

Introduction

It is possible to check the excitation current value that flows into the coil in the detector and its flow direction.

This check is not possible for integral models.

Step	Procedure	Screen
1	Open the excitation current check screen by following the steps to enter the Maintenance Mode. In this situation, the multimeter output will not be stable since the excitation current is flowing rectangularly.	 <p>12.3 % ≥ EX CHECK EXX 160.0</p>
2	Touch the  key once, and the excitation current will be a direct current and will flow from X to Y. Make sure the current reaches 160.0 mA.	 <p>12.3 % > EX CHECK EXX 160.0</p>
3	Touch the  key again, and the current will flow from Y to X. The polarity will be the reverse of the status in Step 2.	 <p>12.3 % > EX CHECK EXY 160.0</p>
4	Touch the  key again, and the excitation current will stop.	 <p>12.3 % > EX CHECK OFF 160.0</p>
5	Finally, touch the  key again to move the cursor to “>”.	 <p>12.3 % ≥ EX CHECK OFF 160.0</p>

False Signal Input by Calibrator

Introduction The electromagnetic flowmeter is provided with a dedicated calibrator, which has the function of generating the same signal as the flow rate signal from the detector. The converter function can be checked using this false signal.

When to use When a problem occurs in the converter, use this method to judge whether detector or the converter is responsible for the problem.

Preparation Prepare the following equipment.

- Dedicated calibrator and dedicated cable
- Digital voltmeter
- Resistor (250Ω)

In addition, the value of the measuring span is needed as data to be input into the dedicated calibrator.

How to check Calibrate the electromagnetic flowmeter according to the calibrator's operating manual. The code of the calibrator's operating manual is CM2-MGZ100-2001.

5-2 Troubleshooting

Overview

Introduction

If a problem occurs at electromagnetic flowmeter start-up and operation, the following three causes should be considered.

- Inconsistency between the electromagnetic flowmeter's specifications and the actual operating conditions

- Missetting or misoperation

- Electromagnetic flowmeter malfunction

If a problem occurs during electromagnetic operation, the converter's self-diagnostic function will classify it as serious or minor. It will indicate this and respond accordingly.

Perform the proper correction measures, referring to the troubleshooting guidelines described in this section.

Serious trouble

Serious problems may obstruct electromagnetic flowmeter operation and finally damage the flowmeter, if not corrected. When serious trouble occurs during electromagnetic flowmeter operation, an error message will appear on the converter's display panel and the flowmeter will continue to output the preset value in the abnormality treatment (fail-safe) direction. The error message and the self-diagnostic results will be visible on the display panel.

Example:

- EX CHECK ERROR: This message appears if the detector coil has been disconnected.

Minor trouble

Minor problems will not seriously obstruct electromagnetic flowmeter operation. When an error occurs during electromagnetic flowmeter operation and is regarded as a minor problem by the converter self-diagnostics, the output will not burn out and the electromagnetic flowmeter will continue to output the instantaneous flow rate.

Errors at Start-up

Troubleshooting

When a problem occurs at start-up, perform the following procedures. If the problem remains, it is possible that the electromagnetic flowmeter has been damaged. Contact the reference listed on the last page of this manual.

Trouble	Check points and treatment
No indication on display panel at power-up.	<ul style="list-style-type: none">• Check the converter power supply specification.• Make sure the ambient temperature is not below -25°C.
No output at power-up.	<ul style="list-style-type: none">• Make sure the signal line is correctly connected.

Errors during Operation

Troubleshooting

When a problem occurs during operation, perform the following procedures.

1. Check against the table on this page for symptoms of the error. If found, perform the steps indicated in the table.
2. When the problem cannot be solved, it is possible that the electromagnetic flowmeter has been damaged. Contact the reference listed on the last page of this manual.

Trouble	Check points and treatment
Output fluctuates excessively beyond the estimated flow rate range.	<ul style="list-style-type: none">• Make sure the electromagnetic flowmeter is correctly grounded.• Make sure the damping time constant is set correctly.• Clean the electrodes.
Output exceeds 100%.	<ul style="list-style-type: none">• Make sure the set range is set correctly.• Make sure the span is set correctly.• Make sure the zero point is correctly adjusted.
Output remains 0%.	<ul style="list-style-type: none">• Make sure the pipe is not empty.• Make sure the signal line is correctly connected.• Make sure the valves are open on the upper and lower sides.• Make sure the span is set correctly.
Output has burnt out.	<ul style="list-style-type: none">• Refer to “Error messages and treatment” to perform measures.

Error Messages and Treatment (Display)

Hardware check

Hardware check is executed in the Measuring Mode.
 Perform the proper measures immediately.
 While an error code (Err-01 to Err-05) is being displayed, the output for the abnormal situation will be as preset in the Engineering Mode.

Error codes for serious trouble

Err - 01
 EX CHECK
 ERROR

Error code	Error contents	Treatment	LCD display
Err-01	Coil disconnected EX open	1. Check connection. 2. Measure coil resistance. 3. Restore power.	EX CHECK ERROR
Err-02	ROM check error	1. Restore power. 2. Replace ROM. 3. Replace main circuit board.	ROM CHECK ERROR
Err-03	RAM READ AFTER WRITE error	1. Restore power. 2. Replace main circuit board.	RAM CHECK ERROR
Err-04	NVM READ AFTER WRITE error	1. Restore power. 2. Replace main circuit board.	NVM CHECK ERROR
Err-05	ADC error A/D change error	1. Restore power. 2. Replace main circuit board.	ADC CHECK ERROR

(Continued on next page)

Error Messages and Treatment (Display) *(Continued)*

Checking for mis-setting

Missetting diagnostics are executed in the Engineering Mode. When a setting is incorrect, the error will be displayed for one second and then the incorrectly-set screen will appear.
(To view the error contents again, press the MODE key.)

Note: Press the MODE key for more than 5 seconds, and the data will return to the status obtaining before entering the Engineering Mode.

Error codes for minor trouble

Error code	Error contents	Treatment	LCD display
Err-13	ALARM1 is smaller than ALARM2.	Change the setting to $ALARM1 \geq ALARM2$.	SETTING ERROR ALM < ALM2
Err-21	Span setting of 12 m/s or more.	Check SPAN, DIA, TYPE, DUMMY settings.	SPAN ERROR OVER 12m/s

ご注文・ご使用に際してのご承諾事項

平素は当社の製品をご愛用いただき誠にありがとうございます。

さて、本資料により当社製品(システム機器、フィールド機器、コントロールバルブ、制御機器)をご注文・ご使用いただく際、見積書、契約書、カタログ、仕様書、取扱説明書などに特記事項のない場合には、次のとおりとさせていただきます。

1. 保証期間と保証範囲

1.1 保証期間

当社製品の保証期間は、ご購入後またはご指定場所に納入後1年とさせていただきます。

1.2 保証範囲

上記保証期間中に当社側の責により故障が生じた場合は、納入した製品の代替品の提供または修理対応品の提供を製品の購入場所において無償で行います。ただし、次に該当する場合は、この保証の対象範囲から除外させていただきます。

- ① お客様の不適切な取り扱いならびにご使用の場合
(カタログ、仕様書、取扱説明書などに記載されている条件、環境、注意事項などの不遵守)
- ② 故障の原因が当社製品以外の事由の場合
- ③ 当社もしくは当社が委託した者以外の改造または修理による場合
- ④ 当社製品の本来の使い方以外で使用の場合
- ⑤ 当社出荷当時の科学・技術水準で予見不可能であった場合
- ⑥ その他、天災、災害、第三者による行為などで当社側の責にあらざる場合

なお、ここでいう保証は、当社製品単体の保証を意味するもので、当社は、当社製品の故障により誘発されるお客様の損害につきましては、損害の如何を問わず一切の賠償責任を負わないものとします。

2. 適合性の確認

お客様の機械・装置に対する当社製品の適合性は、次の点を留意の上、お客様自身の責任でご確認ください。

- ① お客様の機械・装置などが適合すべき規制・規格または法規
- ② 本資料に記載されているアプリケーション事例などは参考用ですので、ご採用に際しては機器・装置の機能や安全性をご確認の上ご使用ください。
- ③ お客様の機械・装置の要求信頼性、要求安全性と当社製品の信頼性、安全性の適合
当社は品質、信頼性の向上に努めていますが、一般に部品・機器はある確率で故障が生じることは避けられません。当社製品の故障により、結果として、お客様の機械・装置において、人身事故、火災事故、多大な損害の発生などを生じさせないよう、お客様の機械・装置において、フルプルーフ設計(※1)、フェールセーフ設計(※2)(延焼対策設計など)による安全設計を行い要求される安全の作り込みを行ってください。さらには、フォールトアボイダンス(※3)、フォールトトレランス(※4)などにより要求される信頼性に適合できるようお願いいたします。

※1. フールプルーフ設計：人間が間違えても安全のように設計する

※2. フェールセーフ設計：機械が故障しても安全のように設計する

※3. フォールトアボイダンス：高信頼度部品などで機械そのものを故障しないように作る

※4. フォールトトレランス：冗長性技術を利用する

3. 用途に関する注意制限事項

原子力管理区域(放射線管理区域)には一部の適用製品(原子力用リミットスイッチ)を除き使用しないでください。医療機器には、原則使用しないでください。

産業用途製品です。一般消費者が直接設置・施工・使用する用途には利用しないでください。なお、一部製品は一般消費者向け製品への組み込みにご利用になれますので、そのようなご要望がある場合、まずは当社販売員にお問い合わせください。

また、

次の用途に使用される場合は、事前に当社販売員までご相談の上、カタログ、仕様書、取扱説明書などの技術資料により詳細仕様、使用上の注意事項などを確認いただくようお願いいたします。

さらに、当社製品が万が一、故障、不適合事象が生じた場合、お客様の機械・装置において、フルプルーフ設計、フェールセーフ設計、延焼対策設計、フォールトアボイダンス、フォールトトレランス、その他保護・安全回路の設計および設置をおお客様の責任で実施することにより、信頼性・安全性の確保をお願いいたします。

- ① カatalog、仕様書、取扱説明書などの技術資料に記載のない条件、環境での使用

② 特定の用途での使用

* 原子力・放射線関連設備

【原子力管理域外での使用の際】【原子力用リミットスイッチ使用の際】

* 宇宙機器／海底機器

* 輸送機器

【鉄道・航空・船舶・車両設備など】

* 防災・防犯機器

* 燃焼機器

* 電熱機器

* 娯楽設備

* 課金に直接関わる設備／用途

- ③ 電気、ガス、水道などの供給システム、大規模通信システム、交通・航空管制システムで高い信頼性が必要な設備

- ④ 公官庁もしくは各業界の規制に従う設備

- ⑤ 生命・身体や財産に影響を与える機械・装置

- ⑥ その他、上記①～⑤に準ずる高度な信頼性、安全性が必要な機械・装置

4. 長期ご使用における注意事項

一般的に製品を長期間使用されますと、電子部品を使用した製品やスイッチでは、絶縁不良や接触抵抗の増大による発熱などにより、製品の発煙・発火、感電など製品自体の安全上の問題が発生する場合があります。お客様の機械、装置の使用条件・使用環境にもよりますが、仕様書や取扱説明書に特記事項のない場合は、10年以上は使用しないようお願いいたします。

5. 更新の推奨

当社製品に使用しているリレーやスイッチなど機構部品には、開閉回数による磨耗寿命があります。

また、電解コンデンサなどの電子部品には使用環境・条件にもとづく経年劣化による寿命があります。当社製品のご使用に際しては、仕様書や取扱説明書などに記載のリレーなどの開閉規定回数や、お客様の機械、装置の設計マージンのとり方や、使用条件・使用環境にも影響されますが、仕様書や取扱説明書に特記事項のない場合は5～10年を目安に製品の更新をお願いいたします。

一方、システム機器、フィールド機器（圧力、流量、レベルなどのセンサ、調節弁など）は、製品により部品の経年劣化による寿命があります。経年劣化により寿命ある部品は推奨交換周期が設定してあります。推奨交換周期を目安に部品の交換をお願いいたします。

6. その他の注意事項

当社製品をご使用するにあたり、品質・信頼性・安全性確保のため、当社製品個々のカタログ、仕様書、取扱説明書などの技術資料に規定されています仕様（条件・環境など）、注意事項、危険・警告・注意の記載をご理解の上厳守くださるようお願いいたします。

7. 仕様の変更

本資料に記載の内容は、改善その他の事由により、予告なく変更することがありますので、予めご了承ください。お引き合い、仕様の確認につきましては、当社支社・支店・営業所 または お近くの販売店までご確認くださいようお願いいたします。

8. 製品・部品の供給停止

製品は予告なく製造中止する場合がありますので、予めご了承ください。

修理可能な製品について、製造中止後、原則5年間修理対応いたしますが修理部品がなくなるなどの理由でお受けできない場合があります。

また、システム機器、フィールド機器の交換部品につきましても、同様の理由でお受けできない場合があります。

9. サービスの範囲

当社製品の価格には、技術者派遣などのサービス費用は含んでおりませんので、次の場合は、別途費用を申し受けます。

- ① 取り付け、調整、指導 および 試運転立ち会い
- ② 保守・点検、調整 および 修理
- ③ 技術指導 および 技術教育
- ④ お客様ご指定の条件による製品特殊試験 または 特殊検査

なお、原子力管理区域（放射線管理区域）および被爆放射能が原子力管理区域レベル相当の場所においての上記のような役務の対応はいたしません。

Document Number : CM2-MGF100-2001
Document Name : MagneW 3000 FLEX Electromagnetic
Flow Switch
(Integral Type, Remote Type Converter)
Model MGF

Date : Dec. 2014 Rev.3
Issued / Edited by : Azbil Corporation

Azbil Corporation